

OCCUPATIONAL HEALTH AND SAFETY PROGRAM



SONIC DRILLING LTD.
ADVANCED DRILLING TECHNOLOGY

Revision Date: January, 2011



Prepared By:
Collins Safety Services Ltd.

Copyright © 2005 Collins Safety Services Ltd.
All Rights Reserved



Table of Contents

Table of Contents

OUR SAFETY POLICY.....

1.0 Roles and Responsibilities.....

 Management and Supervisory Personnel.....

 Worker / Employee Responsibilities.....

 Contractor/Subcontractor Responsibilities

 Visitor Responsibilities

 First Aid Attendant Responsibilities

 Construction Safety Officer Responsibilities (CSO).....

 Safety Coordination Responsibilities (Owner)

2.0 Pre-Project & Site Coordination.....

 Project Security and Public Safety

3.0 Joint Occupational Health & Safety Committee.....

4.0 Education / Training / Communication

 Education and Training Policy.....

 New / Young Worker Orientation

 Toolbox Talks

 Toolbox Safety Meeting Preparation and Presentation

5.0 General Safety Rules and Instructions Policy.....

 General Safety Rules.....

 Disciplinary Action Policy

 Minor Infraction

 Major Infraction

6.0 Specific Safety Rules

 Alcohol and Drugs.....

 Code of Conduct.....

 Discriminatory Actions.....

 Radios.....

 Smoking.....

 Violance

7.0 Accident / Incident Investigating and Reporting.....

 Accident / Incident Investigating.....

 Accident Scene (Location) Preservation

8.0 Safe Work Practices / Procedures / Instruction.....

9.0 Workplace Hazard Assessment and Control.....

 Workplace Hazard Assessments / Job Hazard Analysis

10.0 Inspections

 Informal Workplace Inspections

 Formal Workplace Inspections.....

 Safety Committee Inspections

 Special Inspections



Table of Contents

- 11.0 Environment / Exposure / Hygiene Control**.....
- Workplace Hazardous Materials Information System (WHMIS)
- Environmental Protection
- Waste Management.....
- Exposure Control
- Specific Occupational Hygiene Initiatives
- Blood Borne Pathogens
- Lead.....
- Respiratory Protection.....
- Temperature Extremes – Cold
- Temperature Extremes – Heat.....
- 12.0 Emergency Preparedness and Response**
- First Aid.....
- Earthquake Plan
- 13.0 Records and Statistics Policy**
- Records
- Statistics
- 14.0 Preventative Maintenance Policy**.....
- Tools and Equipment Maintenance Program
- Mobile Equipment Maintenance Program.....
- Scheduled Inspections and Maintenance
- 15.0 Legislation**
- Workers Compensation Act
- Occupational Health and Safety Regulation
- Guidelines.....
- Policies
- 16.0 Supplemental Programs and Appendices**.....
- Appendices/Forms
- Programs
- 17.0 Program Review**
- Program review policy
- Procedures
- Program Audit.....

IMPORTANT: Please refer to section 16.0 “Supplemental Programs and Appendices” for further information regarding the “Employee Health and Safety Manual”

As we strive to stay current with health and safety legislation, regulation, guidelines and policies for the protection of our workers, the information contained in this 2011 OCCUPATIONAL HEALTH AND SAFETY PROGRAM should be used in conjunction with the information in the “Employee Health and Safety Manual”.



Our Safety Policy

OUR SAFETY POLICY

Sonic Drilling Ltd is committed to a strong Health and Safety Program that protects its employees, contractors, customers, clients, the public and property from accidents and/or incidents occurring on our projects.

We believe that all accidents are preventable. Our goal is ZERO accidents.
Active participation at all levels will ensure that our goal can be achieved.

Sonic Drilling Ltd endeavours to provide proper and relevant employee training, job specific safe work practices, project and personal protection equipment, operation and maintenance procedures, and safety guidelines that focus management, employee and contractor awareness on reducing the risk of accidents and/or incidents in all activities.

Sonic Drilling Ltd, contractor employers and contractor employees are responsible for fully complying with all health and safety standards and regulations, including the *Workers Compensation Act* and the *Occupational Health and Safety Regulation* (the "OHS Regulation"), and for co-operating with management in the implementation of the Health and Safety Program, worksite inspections, incident/accident investigations and in the continuous improvement of this program.

We are committed to safe and sustainable practices in all aspects of our operations and therefore will review and update our safety program on a yearly basis to adapt to industry changes, trends and requirements.

Sonic Drilling Ltd management, contractor management and all employees are collectively responsible to ensure compliance with local government, occupational health, safety and environmental regulations.

Signed: _____
Name Here

Reviewed: _____
Date



Roles and Responsibilities

1.0 ROLES AND RESPONSIBILITIES

Management and Supervisory Personnel

Management and Supervisory Personnel are responsible for ensuring that:

- Periodic meetings of management personnel are held for the purpose of reviewing health and safety activities and accident trends and determining necessary courses of corrective actions.
- Support and direction necessary for the effective implementation of the health and safety program are provided and health and safety policies, procedures and regulations are enforced.
- Workers are informed of any potential or actual dangers to their health and safety, are instructed in Personal Protective Equipment, safe work practices, rules and WCB requirements and policies. (Also See "Personal Protective Equipment Program" - Supplemental Programs and Appendices)
- Employees are not permitted to work when their actions indicate that the work would jeopardize themselves or others.
- Appropriate records and statistics are maintained and made available, where required, to inspectors, investigators or other regulatory personnel.
- Where required by WorkSafeBC, a Notice of Project is completed and submitted at least 24 hours prior to workers commencing work and a copy is posted at the construction site.
- Where required by the WorkSafeBC, a qualified coordinator/person is designated to be responsible for project health and safety activities.
- Where practicable, new work areas are inspected prior to commencement of work.
- Daily informal inspections are undertaken, for jobs anticipated to last more than two weeks, bi-weekly planned inspections of work areas, equipment, tools, work methods and practices are undertaken.
- Completed inspection reports are submitted to management at the earliest opportunity.
- Immediate action, as authorized by management, is undertaken to correct substandard safety practices and conditions identified through inspections or reported to management / supervisory personnel.
- All accidents required to be investigated by the WCB regulation, are investigated for the purpose of identifying causes and necessary corrective actions.
- Accident investigation reports are reviewed and necessary courses of corrective action are implemented through directives to appropriate personnel.
- A company representative accompanies WorkSafeBC officers performing inspections and is shown complete cooperation.



Roles and Responsibilities

- Copies of the WCB Regulation and company Health and Safety Program are made readily available on the job site or workplace and accessible to workers.
- Copies of all WorkSafeBC Inspection Reports, received at the job site, are forwarded to head office at the earliest opportunity and posted on the job in a conspicuous place.
- If regulatory infractions are noted on a WCB inspection report, necessary corrective actions are authorized and implemented at the earliest practicable opportunity.
- Job site health and safety activities are coordinated with subcontractors and the principal contractor or owner.
- Where there is a workforce of twenty or more workers, company representatives are provided to participate in the project health and safety committee.
- An adequate supply of appropriate personal protective equipment is provided, used and maintained on the job site as required.
- Required first aid and emergency facilities are maintained on the job.
- Weekly tool-box safety meetings are held for personnel to:
 - a) discuss observed unsafe work practices and conditions,
 - b) review and implement corrective action to eliminate unsafe practices and conditions, and
 - c) encourage safety suggestions from workers.
- WHMIS-controlled products are identified and labelled and appropriate Material Safety Data Sheets (MSDS) are readily available.
- A procedure is developed for periodically checking the well-being of workers assigned to work alone under conditions that present a risk of disabling injury.
- A good example is set for all workers.



Roles and Responsibilities

Worker / Employee Responsibilities

We expect all workers and/or employees to take an active part in the Occupational Health and Safety Program. This can be accomplished by, but is not limited to the following:

The worker/employee must:

- They are familiar with and comply with all applicable requirements of the company Health and Safety Program and the WorkSafeBC Regulation.
- They report all unsafe conditions and practices to their immediate supervisor and take corrective action, when practicable, to eliminate such hazards.
- They do not operate equipment unless they are authorized and trained to do so, all safeguards are in place and functional, and no person will be endangered.
- They immediately report to a company supervisor and the first aid attendant all work-related injuries and health problems and cooperate in the investigation of such incidents.
- If they have a physical or mental impairment which may affect their ability to work safely (e.g.: back problems, epilepsy), they inform their supervisor of the impairment and do not work where the impairment may create an undue risk to themselves or anyone else.
- They do not enter or remain at the workplace if under the influence of alcohol, prescription or illegal drugs which may impair their ability to do their job safely.
- They do not engage in any improper activity or behaviour (horseplay, scuffling, fighting, practical jokes or similar conduct) that may endanger themselves or others.
- They maintain good housekeeping and enter/leave their work area using safe routes.
- They wear appropriate personal protective equipment and maintain it in good working order.
- They do not carry out or cause to be carried out any work process or operate or cause to be operated any tool, appliance or equipment if there is reasonable cause to believe that to do so would create an undue hazard to the health or safety of any person.
- They use WHMIS-controlled materials in accordance with WHMIS recommendations.
- They actively participate in tool-box safety meetings to help maintain safe conditions on site.
- They set a safe example for all other workers.



Roles and Responsibilities

Contractor/Subcontractor Responsibilities

All contractors/subcontractors shall be made aware of our Occupational Health and Safety Program rules and regulations. The Contractor Supervisors and/or Foreman shall be responsible for the direct supervision and safety of their crew. They are accountable to the Project Superintendent for the performance of personnel through the safe work practices and procedures as well as any other applicable Acts and Regulations. It is the contractor/subcontractor's responsibility to perform the job in compliance with our safety standards or other applicable legislation.

Any infractions not immediately corrected as directed by Sonic Drilling Ltd will result in the contractors/subcontractors being advised of the breach of contract and the action that will be taken as a result of the breach according to company policy. It must be firmly established that our safety program protects all workers on the job, including all subcontractor's employees.

All contractor/subcontractors must:

- Read and understand our company Health & Safety Program. Must be knowledgeable of and comply with all regulations, laws and codes.
- Ensure all his/her employees complete a company orientation when/where required prior to his/her employees working on site.
- Enforce all established safety regulations and work methods. Take disciplinary action necessary to ensure compliance with the rules.
- Conduct a Job Hazard Analysis (JHA) for all tasks where moderate to high risk activities are prevalent within the scope of work. Includes his/her work crew in the completion of these JHA's.
- Ensure that a trade safety representative will attend regular Site Safety Meetings.
- Hold regular "Tool Box Talk" meetings with his/her crew, record the meeting, and submit a copy to the project supervisor for review.
- Conduct regular inspections for unsafe practices and conditions and ensure prompt corrective action to eliminate causes of accidents and "near misses".
- Complete an accident/incident report ensuring all accidents/incidents are investigated and corrective action is taken to prevent re-occurrence. Copies of the report are given to the project supervisor.
- Inform each employee of the hazards associated with his/her job and provides the training in the safe work practices required to perform his/her job safely.
- Impart to each employee an understanding that violation of established safety rules will not be tolerated.
- Ensure that required safety equipment and PPE are provided and used for each job.
- Observe new hire employees closely until confident of workers ability to perform assigned duties safely.



Roles and Responsibilities

Visitor Responsibilities

Each visitor is responsible for safe guarding his/her own health and safety.

All visitors must:

- Report to the project office and obtain permission for entry onto the project site.
- Participate in the orientation program and complete the required documents.
- Wear approved personal protective equipment. (Approved boots, hardhat, & high visibility vests).
- Comply with Local Government Safety Legislation and Safety Program Requirements.
- Report any unsafe acts or conditions to the Project Superintendent.
- Report any injuries sustained on the site to the Project Superintendent.

First Aid Attendant Responsibilities

The first aid attendant shall assist in the ongoing safety efforts in the workplace through efforts in promoting safety amongst all employees and subcontractors. This basic responsibility includes, but is not limited to the following:

The First Aid Attendant must:

- Administer First Aid as required.
- Ensuring that adequate first aid equipment is available, first aid room in neat, clean, and properly stocked and meets all WCB requirements.
- Providing general induction and orientation to new workers.
- Reporting hazards to the site supervisor.
- Ensure workers who wear respirators are fit-tested and trained in the proper usage, care and maintenance of their respirators.
- Ensure the First Aid Log book is completed accurately and kept confidential.
- Coordinate the transportation of injured workers to a physician's office or hospital.
- Check with workers as to who holds a valid first aid certificate and maintenance of own first aid qualifications as required
- Assist the Site Safety Officer when necessary.
- Implement and post a site safety plan.
- Setting a good example.



Roles and Responsibilities

Construction Safety Officer Responsibilities (CSO)

The site superintendent is the individual who is responsible for prioritizing the following responsibilities. The CSO is an extension of the superintendent's authority with respect to health and safety but cannot supersede it. All health and safety occurrences must be reported back to the supervisor.

The Site Safety Officer is responsible for the daily administration of the Safety Program on site, and must:

- Conduct and document orientations for all new workers on site.
- Ensure all aspects of the company Safety Program have been implemented as required.
- Post all company Safety Bulletins, WorkSafeBC inspection reports, and safety rules and requirements.
- Obtain a copy of the sub-trades' Fall Protection Plan. This is required if any of the trades' workers are exposed to a fall of 25 feet or greater.
- Record the name and phone number of the CSO, TSC or designated safety person for each sub-trade.
- Report all hazards to the Project Supervisor and if possible, eliminate the hazard immediately.
- Obtain and review with the sub-trade a copy of their Contractor Safety Information Form, and where appropriate, Safe Work Procedures.
- Conduct and document a minimum of 2 daily site inspections and follow up on these inspections to ensure that any corrective action required has been completed.
- Ensure that weekly toolbox talks are conducted and documented by each trade.
- Record WorkSafeBC and company regulation infractions including any fines on appropriate forms.
- Record safety / regulation infractions by visitors, delivery people or inspectors.
- Assist contractors to conduct frequent hazard assessments and collect appropriate documentation.
- Arrange Site Safety Meetings every month and have workers sign in. The WorkSafeBC Safety Officer for the site should be invited to the first meeting, if possible.
- Update and maintain current Material Safety Data Sheets for all hazardous substances on site.
- Ensure sub-trades are holding Trade Tool Box Talks when they change activities and before jobs with risk of injury are started.
- Assist Project Supervisor(s) in accident investigation, analysis and preparation of accident reports and summaries.



Roles and Responsibilities

Safety Coordination Responsibilities (Owner)

The site owner is responsible for ensuring that Sonic Drilling Ltd personnel are informed of any hazards related to owner operations or site conditions, and the procedures to be used to address those hazards.

The Prime Contractor, or in the absence of a Prime Contractor, the Owner is responsible for co-ordinating site health and safety activities on a construction site that has two or more employers, and the site has overlapping or adjoining work activities that create a hazard to workers. In these situations the owner, or if the owner engages a prime contractor, the prime contractor, will:

- **Appoint a qualified coordinator to:**
 - a. ensure coordination of health and safety activities for the location
 - b. inform employers and workers of hazards created
 - c. ensure hazards are addressed throughout the duration of the work activities, and;

- **Post:**
 - a. the name of the qualified coordinator
 - b. a site drawing showing project layout, first aid location, emergency transportation provisions, and the evacuation head-count location
 - c. a set of construction procedures designed to protect the health and safety of workers at the workplace, developed in accordance with the requirements of the Workers Compensation Act (WCA) and Occupational Health & Safety Regulation (OHSR)

For multi-employer worksites, as described above, each employer must:

- Give the Prime Contractor's Qualified Coordinator the name of a Qualified Person designated to be responsible for their site health and safety activities, and;

- Notify the owner or the prime contractor if one has been engaged, in advance of any undertaking likely to create a hazard for a worker of another employer.



Pre-Project & Site Coordination

2.0 PRE-PROJECT & SITE COORDINATION

Sonic Drilling Ltd recognizes the need and value of planning ahead. By reviewing and evaluating contractor suggestions, issues and recommendations that originate from initial hazard assessments can greatly reduce the risk in the future. To do this we will conduct a pre-construction meeting consisting of a representative from each trade to review the health and safety requirements specific to that project site.

A record of this meeting and the issues discussed must be kept for due diligence purposes. At the Site Meeting the Sonic Drilling Ltd coordinator will ensure that all contractors/sub-contractors initial issues and concerns are addressed as well as details of the site specific safety information is passed along.

This would include (but limited to):

- Health & safety program requirements.
- Hazards assessment results from existing and planned work.
- Emergency response plans & procedures including site specific safety information.
- Site specific safety orientation requirements.
- Collection of trade safety person designated to be responsible for safety coordination.

Project Security and Public Safety

Every effort shall be made to secure the project and protect the surrounding public whenever possible. It shall be the responsibility of project management to arrange to have the site location and its surroundings assessed and evaluated for any necessary safety and security issues or concerns upon retaining ownership and/or responsibility of the property. The evaluation of hazards surrounding the project shall be consistent with our mandate to personal safety to prevent potential incident and/or injury by preventing access by the public. The evaluation and the need for safety and security measures before and during construction shall also be consistent with the responsibility for the protection of the public, site personnel, and equipment.

General considerations and requirements include (but are not limited to):

- Ensure proper, secure perimeter fencing and/or hoarding is in place around site to prevent access.
- Ensure conditions of the site specific insurance policy have been met with respect to overall safety, fencing, security, lighting, hot works etc. as agreed to for the project.
- Ensure all existing utilities have been effectively addressed where applicable (i.e. BC Hydro 30m33)
- Notify the local Fire Department of the project and arrange a site visit to evaluate and assess the location and conditions which may require advanced rescue planning when required.
- Ensure that all necessary and current engineering drawings are on site before commencing excavation.
- Ensure security services are retained for the above when/where required.
- Ensure required First Aid services and equipment are on site when/where required.
- Ensure all safety signs are posted at all site entrances as per policy.
- Ensure copies of the Sonic Drilling Ltd Health & Safety Program and the WorkSafeBC OH&S Regulation are on site or have access to this information by way of Internet access.



Joint Occupational Health & Safety Committee

3.0 JOINT OCCUPATIONAL HEALTH & SAFETY COMMITTEE

The *Workers Compensation Act* requires employers to establish a Joint Health And Safety Committee in any workplace that regularly employs 20 or more workers (full and part time). The WCB may also require other workplaces to establish a health and safety committee.

The Safety Committee shall assist in creating a safe place of work, shall recommend actions which will improve the effectiveness of the safety program and shall promote compliance with WorkSafeBC OHS Regulation. Each Sonic Drilling Ltd project site will form a committee in the following manner:

GUIDELINES

- The meeting must occur a minimum of once a month; once every week when required;
- The meeting must be separate from weekly production meetings, or General Site Safety Meeting;
- The meeting must be documented and filed.

COMMITTEE MEMBERSHIP

- One representative of each contractor/trade must attend.
- Not fewer than four regular members employed at the jobsite and experienced in the types of work being performed at the jobsite.
- Membership chosen by and representing the workers and the employer. In no case shall the employer's representatives outnumber the worker's representatives.
- Two Co-Chairpersons elected from and by the members of the committee. Where the Chairman is an employer, (Supervisor) the secretary must be a worker member and vice versa.

SAFETY COMMITTEE

Co-Chairperson's Duties

The Co-Chairpersons are responsible for:

- Arranging the meeting time, date and place;
- Preparing the agenda;
- Reviewing previous minutes and new materials;
- Chairing the meeting.



Joint Occupational Health & Safety Committee

Secretary's Duties

The secretary is responsible for:

- Recording, preparing and distributing minutes;
- Notifying members of meeting;
- Reporting the status of recommendations.

Committee Duties

A joint committee has the following duties and functions in relations to its workplace:

- To identify situations that may be unhealthy or unsafe to workers and advise on effective systems for responding to those situations;
- To consider and expeditiously deal with complaints to the health & safety of workers;
- To consult with workers and the employer on issues related to occupational health & safety and occupational environment;
- To make recommendations to the employer and the workers for the improvement of the occupational health & safety and occupational environment of workers;
- To make recommendations to the employer on educational programs promoting the health and safety of workers and compliance with the regulations and to monitor their effectiveness;
- To advise the employer on programs and policies required under the regulations for the workplace and to monitor their effectiveness;
- To advise the employer on proposed changes to the workplace or the work processes that may affect the health and safety of workers;
- To ensure that accident investigation and regular inspections are carried out as required by the regulation;
- To participate in inspections, investigations and inquires as provided in the regulations;
- To carry out any other duties and functions prescribed by regulation.

Safety Committee Meeting Typical Agenda

The Safety Committee form shall be completed for each meeting.

- Call to order;
- Roll call – Chairman introduces any guests or visitors present;
- Review business arising out of previous minutes;
- Reading of relevant correspondence and reports;
- Incident/Accident, near miss review;
- Recommendations and suggestions;
- Discuss the work schedule and its impact on safety;
- New business;
- Set date, time and location for next meeting;
- Adjournment.



Education / Training / Communication

4.0 EDUCATION / TRAINING / COMMUNICATION

Education and Training Policy

Sonic Drilling Ltd recognizes that training and education of workers is a vital part of our health and safety program. Our employees must have the knowledge and skills to do their work in a safe manner. Safety instruction will be provided to all workers, and workers are required to comply with these instructions.

Our program of worker education and training will consist of:

- Conducting worker orientation sessions for new workers and site specific orientations.
- Conducting Toolbox Talks on a regular basis during construction projects.
- Developing safe job procedures and instructing workers in these procedures.
- Monitoring ongoing requirements for health and safety instruction.
- Delivering specialized training for employees as may be required.

Job specific training of employees is conducted when, but is not limited to the following situations:

- When a new employee is hired.
- When an employee is assigned new or different work.
- When an employee is moved to a new site or location

This training will be conducted by the employee's immediate supervisor and will contain the following items:

- Review of safe work practices and procedures that apply to the specific job.
- Bring all known safety hazards that may affect the employee to his/her attention.
- Determine just what the employee can do and how he/she does it. This includes both discussion with the employee and observation of how he/she does the work.
- Provide the employee with all the information and Personal Protective Equipment (PPE), that is necessary for the employee to do the job safely and correctly.

Depending on the complexity of the job and the employees skill/experience level, job specific training may take anywhere from a few minutes to several months. Ensure training documentation is kept on site and made available to Sonic Drilling Ltd upon request. The on-going monitoring and coaching of the worker is a major duty and responsibility of that worker's immediate Supervisor/Foreman.



Education / Training / Communication

New / Young Worker Orientation

Employees of Sonic Drilling Ltd will receive an orientation session. This new worker orientation will be used to review general health and safety program requirements as required by WorkSafeBC regulations. Orientations will also be conducted at the start of new projects that deals with site/project specific health & safety requirements.

Orientation of new employees and all contractors and their employees is mandatory and must be completed prior to commencement of work on all sites. It is the responsibility of the trade supervisor/foreman to ensure their workers complete the Sonic Drilling Ltd Orientation prior to starting work.

The orientation will include safety information specific to the site/project and the expected duties the worker will perform. The site superintendent, health & safety coordinator, or worker's supervisor may conduct the orientation session. As a minimum the site specific safety orientation should include (but not be limited to) the following:

- The identification of worksite hazards, and the safe procedures for dealing with these hazards
- How to report hazards, injuries, accidents and near misses
- Information regarding current site-specific safe work procedures in use
- The requirements for personal protective equipment to be used generally on site, and for specific tasks
- The location of safety reference materials including:
 - Written safe work procedures
 - Health & Safety Manual
 - Material Safety Data Sheets (MSDS)
 - WORKSAFE BC Occupational Health & Safety Regulation (OHSR)
 - Workers Compensation Act
- The location of first aid facility(s), services and emergency equipment
- The means of summoning aid, including emergency signals
- Name of their supervisor and the site superintendent, and how to contact them
- Names of safety committee representative and how to contact them

The initial orientation training needs to be followed-up with further training of workers when any of the following conditions exist:

- The work to be conducted has not been done before, and new or modified work procedures are required
- There is an obvious skills and/or knowledge gap that prevents the worker from completing tasks as required
- A worker requests training for work activities with which they are not familiar
- WORKSAFE BC directs that training is required

Sonic Drilling Ltd will assist the employee in ensuring that the required training takes place. The training will be competency based in order for it to be effective and meet the test of due diligence. Competency based means that the essential skills and knowledge required to do the work correctly have been identified, included in the training, and passed on to the worker.



Education / Training / Communication

Toolbox Talks

Toolbox Talks are a key element of worker education and training. Toolbox Talks must be conducted with a specific topic for discussion such as a safety rule, safe job procedure, a recent incident, health and safety committee meeting minutes, inspection results, etc. They will be used to discuss hazards and provide information on how we will minimize or remove the risk of injury. All workers on site must attend the Toolbox Talks, which will generally be 15 minutes or less in duration.

The following basic guidelines for Toolbox Talks are to be followed:

- Toolbox Talks are to be held before the commencement of a different scope of work.
- All workers must attend.
- Meetings should be limited to 10 to 15 minutes.

Toolbox Safety Meeting Preparation and Presentation

Preparing for Tool-Box Safety Meetings involves:

1. Deciding on a topic:
 - think of your own experiences, observations, and beliefs,
 - think of your area of control, repeated problems, recent accomplishments, needs for improvement, think of your workers, their wants and needs, opinions, and attitudes,
 - keep notes of day-to-day occurrences that could form a basis for interesting safety talks,
 - read safety-related material, and clip articles for later discussion,
 - confine the topic to one main idea; don't try to talk about everything!
2. Summarizing your talk in point form for reference:
 - know what you are going to say,
 - write down the key points, facts and examples,
 - practice your talk - run through your material before presenting it to your workers, perhaps using a family member, a fellow supervisor or even a mirror as your audience.

When you deliver your talk:

- relate to the crew's attitudes, abilities and interests,
- let your crew hear and see your talk - use brief demonstrations, simple graphs, displays, WCB posters, news articles, accident location, etc.,
- involve your crew by encouraging questions and discussions,
- keep your message clear and understandable,
- answer spoken and unspoken questions - your crew will always have the following questions in mind: What does it mean to me? What do you want me to do? What's in it for me? What will happen if I opt out?



General Safety Rules and Instructions Policy

5.0 GENERAL SAFETY RULES AND INSTRUCTIONS POLICY

All Sonic Drilling Ltd employees will be instructed in, and provided with, written rules and supplementary instructions as necessary to minimise accidents. Sonic Drilling Ltd will determine which rules and supplementary instructions are needed by:

- reviewing inspection, accident investigation and first aid records
- observing employees performing their work activities
- evaluating worker or Joint Occupational Health & Safety Committee recommendations
- reviewing WORKSAFE BC requirements
- analysing new work processes and contract specifications

Supervisory staff is responsible for ensuring worker understanding of, and compliance with, general safety rules and instructions. The safety rules and instructions provided in our program may not cover all the health and safety requirements employees will be expected to follow for each different situation - they are intended to remind employees of the more obvious conditions. **If any employee has any concerns regarding the health or safety of a work process, they are encouraged and directed to consult with their immediate supervisor for additional instructions. The basic philosophy of Sonic Drilling Ltd is**

" Safety First ! "

There is no chance worth taking that may jeopardise the safety or health of any employee or the public.

Instructions will be enforced in the same manner as safety rules, and the Workers Compensation Act (WCA) and Occupational Health & Safety Regulation (OHSR). Compliance with the WCA & OHSR and our safety program requirements is mandatory on all of our projects. Wilful or negligent non-compliance with good health and safety practices by any employee may result in injury or damage, and will result in disciplinary action.



General Safety Rules and Instructions Policy

General Safety Rules

1. All workers on Sonic Drilling Ltd projects are to follow the instruction of the Site Safety Officer and/or Sonic Drilling Ltd Management concerning safety matters.
2. Equipment operators are responsible for the safe maintenance, operation, and required documentation of the machines and equipment that they are operating. This includes strict adherence to the established work practices and safety procedures for that equipment.
3. Workers on Sonic Drilling Ltd projects must use the necessary personal protective equipment when required or when instructed to do so by a Supervisor, or the Site Safety Officer. High visibility vests are required when working around all mobile machinery or when required and instructed to do so by site safety personnel.
4. Horseplay of any type is not permitted.
5. Hardhats and safety boots must be worn at all times. The only amendment will occur when the Project Superintendent has made an exception in writing, based on a Job Hazard Analysis (JHA).
6. All workers must possess a valid audiometric hearing test card. This card must be carried with the worker at all times while on the job site. Any workers not possessing a valid card shall notify the Project Superintendent. Hearing tests will be arranged.
7. Maintain a clean site. Clear and unobstructed access must be provided to all work areas. Good housekeeping is essential.
8. Site Safety Meetings will be held with all workers present once every four weeks or more frequently as circumstances dictate by site safety personnel or at the discretion of safety management.
9. Workers shall not enter an excavation greater than four feet in depth unless the sides are sloped or a geo-technical engineer has certified it safe to do so, and submitted a signed and sealed authority.
10. All injuries, no matter how minor, are to be reported immediately to the Site Safety Officer and/or First Aid Attendant and to your Supervisor/Foreman.
11. No shorts or sleeveless shirts shall be worn unless approved by a supervisor.
12. Workers are to protect themselves from fall hazards by implementing appropriate protection measures.
13. If you create an impalement hazard (i.e. rebar dowels), then you must effectively guard the hazard.



General Safety Rules and Instructions Policy

Disciplinary Action Policy

All safety rules and procedures contained in the Sonic Drilling Ltd Health & Safety Program shall be practiced and enforced by all site personnel. Compliance with this Health and Safety Program rules and instructions, WCB Regulation and any other applicable federal, provincial or local regulations is mandatory. Disregard or negligence in complying with good health and safety practices by any employee may result in unnecessary injury and will be cause for disciplinary action. When disciplinary action is required against non-compliance of a regulation or company instruction as set out in this safety program, the immediate supervisor shall utilize and follow the following guideline for disciplinary action and:

- Conduct an assessment of the incident.
- Render a decision for remediation and/or corrective action.
- Report the incident and remedial action to Head Office without delay.

Actions of a hazardous nature or are considered unacceptable or has been determined as a result of the assessment which will result in disciplinary action are:

Minor Infraction

Definition: Any infraction of government, corporate, or client rules that **does not** have the potential to cause serious damage or injury.

1st offense	Verbal warning
2nd offense	Written warning and/or fine *
3rd offense	Suspended from site until further notice
4th offense	Banned from all job sites

* *Fines:* Shall be based on the assessment information and/or evidence gathered and will result in a minimum \$_____ ***fine or greater*** concluded at the discretion of the Project Manager.

Major Infraction

Definition: Any infraction of government, corporate or client rules or legislation that **DOES** have the potential to cause serious damage or injury.

1st offense	Written warning and/or fine *
2nd offense	Suspended from site until further notice
3rd offense	Banned from all job sites

* *Fines:* Shall be based on the investigative information and/or evidence gathered and will result in a minimum \$_____ ***fine or greater*** concluded at the discretion of the Project Manager.



Specific Safety Rules

6.0 SPECIFIC SAFETY RULES

Alcohol and Drugs

The bringing of, or the consumption of alcohol or other non-prescription drugs on the job site or working while under the influence will not be permitted. Workers will be removed from the site and banned on all Sonic Drilling Ltd projects. Any worker taking prescribed medications must report this to their Supervisor/Foreman and the Site Safety Officer and/or First Aid Attendant.

Code of Conduct

Engaging in horseplay, fighting, practical joking, unnecessary running or jumping and other similar conduct is forbidden and may result in disciplinary action. You are expected to act and work professionally at all times and show courteous behaviour to all workers and the general public. Knowing or intentionally engaging in hazardous behaviour is forbidden and may result in disciplinary action.

Discriminatory Actions

Recent changes to the Workers Compensation Act (WCA) now include requirements for the prohibition of discriminatory actions against workers in regards to health & safety issues. Sonic Drilling Ltd supports this initiative and will require compliance from all Sonic Drilling Ltd staff and employees. You will not be disciplined in any way for acting on your health and safety responsibilities. Discriminatory actions (as defined in the Workers Compensation Act) against persons acting on their health and safety responsibilities will not be tolerated. Persons practicing discriminatory actions will be subject to company disciplinary procedures.

Radios

The uses of I-Pods, MP3 Players or Walkmans are not permitted on the job site. Portable radios are permitted unless they interfere with a worker's ability to recognize a site evacuation alarm; or disrupt other workers. The Project Superintendent may choose to ban all radios if volume levels are not respected.



Specific Safety Rules

Smoking

It is the policy of Sonic Drilling Ltd to prevent illness or other hazards from smoking in the workplace. Sonic Drilling Ltd will endeavour to prevent exposure to workers from second hand smoke.

Smoking is not permitted in the following locations on any Sonic Drilling Ltd project site.

- During refuelling or around fuel storage areas;
- Any wood frame building
- Within the structure being built, no matter what stage;
- Areas where construction debris is being disposed of;
- Site offices, First Aid rooms, or sales areas;
- Other locations designated by the Project Superintendent as non-smoking areas.

Smoking will only be permitted outdoors, in areas designated by the Project Superintendent as smoking locations.

Workers found in non-compliance of this policy will be subject to disciplinary action ranging from suspension to termination dependant upon specific circumstances and repeat offenses, if any.

Violence

Sonic Drilling Ltd is committed to providing a work environment that is free from violence. Any acts or threatened acts of violence will not be tolerated. Anyone engaging in violent behaviour will be subject to discipline, up to and including termination, and may also be personally subject to other civil or criminal liabilities. This policy requires the combined efforts of all employees to enforce. Employees will report any act of violence or any threat of violence to their supervisor. All such reports will be fully investigated. Every effort will be made to keep employees safe at work.

Supervisors, Managers and/or Department Heads shall take the workplace violence concerns of employees seriously. They will trust the instincts of employees who are worried or fearful of another employee or customer. They will bring bizarre, erratic, or aggressive employee/citizen behaviour to the attention of the Personnel Director. Swift corrective and/or disciplinary action will be taken as necessary to stop aggressive behaviour. Law Enforcement support will be obtained as necessary to ensure workplace safety.



Accident / Incident Investigating and Reporting

7.0 ACCIDENT / INCIDENT INVESTIGATING AND REPORTING

Accident / Incident Investigating

The purpose of accident/incident reporting and investigations is to prevent a recurrence of the hazardous condition causing the event. WorkSafeBC requires all employers to report and investigate any accident which:

- resulted in injury requiring treatment by a medical practitioner
- resulted in death or critical condition with a serious risk of death
- involved a major structural failure or collapse
- involved the major release of a toxic or hazardous substance
- was a blasting or diving accident
- did not result in an injury but had the potential for causing serious injury (near miss).

All **work-related** accidents, injuries and diseases must be reported to your supervisor and the first aid attendant at the earliest opportunity. The first aid attendant will enter a written record of your treatment in the first aid record book and, where necessary, will complete a WCB Form 7 (*First Aid Report*) and forward it to the project supervisor. You may be requested to complete a WCB Form 6A (*Worker's Report of Injury or Industrial Disease to Employer*) to give to your supervisor.

All accidents/incidents with potential of injury or property loss shall be reported to the Project Supervisor immediately. He/she will initiate an investigation, interview witnesses and implement corrective action. The contractor Supervisor is also responsible to conduct an accident/incident investigation and submit it to the Project Supervisor and/or Site Safety Officer.

An injury report must be made to the first aid attendant as well as your supervisor. Sign the treatment forms as written notification of accident and injury. If an injury occurs when no supervisors are present, phone the company office to report the accident. All reports must be made before the end of the shift if possible. If necessary, an injured employee may report direct to his doctor but must subsequently provide the company with information regarding:

- reasons for going directly to the doctor;
- date and time of visit; and
- doctor's directions.

All accidents involving damage to equipment or property must be reported to your supervisor. If the supervisor is not available, the damage must be reported to the company office. Near misses that could have resulted in a serious injury or property damage must be reported to your immediate supervisor. Worker's Report of Injury or Industrial Disease to Employer (WCB Form 6A) must be completed by injured worker when they are fit to do so.

Accident Scene (Location) Preservation

In the event of a serious accident, **nothing must be removed from or changed on the accident location** before a WCB representative has given clearance to do so **except where necessary to facilitate rescue operations or to prevent imminent injury.**



Safe Work Practices / Procedures / Instruction

8.0 SAFE WORK PRACTICES / PROCEDURES / INSTRUCTION

Safe Work Practices/Safe Job Procedures should be established for addressing significant hazards or for dealing with circumstances that may present other significant risks/liabilities for the company. They should reflect **your** company's approach to controlling hazards.

Some regulations require employers to have written procedures/instructions for specific activities/conditions. The number of practices/procedures and the degree of detail will depend on the range of work activities your company performs. It is important that management and supervision are involved in the development of safe work practices and that they provide adequate training for workers likely to follow these practices.

We suggest that you build your collection of safe practices/procedures incrementally - start with a few major items and add to them as needed. Avoid simply repeating clear regulatory requirements, rather, if needed; provide direction on how your company will implement/apply those requirements.

Safe work practices	Safe job procedures
Definition	
Safe work practices are generally written methods outlining how to perform a task with minimum risk to people, equipment, materials, environment, and processes.	Safe job procedures are a series of specific steps that guide a worker through a task from start to finish in a chronological order. Safe job procedures are designed to reduce the risk by minimizing potential exposure.
Development	
Safe work practices should be developed as a result of completing a Hazard Assessment and should closely reflect the activities most common in the company's type or sector of construction.	Safe job procedures are usually developed by management and workers as a result of a Hazard Assessment, accident investigation and/or as a supplement to a safe work practice.
Delivery	
All safe work practices should be kept in a location central to the work being performed and readily available to the workforce. Some safe work practices will require specific job procedures, which clearly set out in a chronological order each step in a process.	Safe work procedures should be included in the company's "Worker Orientation" program. All workers should be aware of the fact that safe job procedures have been established, are in effect, are written down and must be followed.

IMPORTANT:

Please also refer to the “EMPLOYEE HEALTH AND SAFETY MANUAL” in section 16.0 for the safe work and start up procedures with respect to all SONIC drilling equipment.



Safe Work Practices / Procedures / Instruction

ACCESS AND EGRESS

Access and Egress Protocol

1. Areas of access and egress must be adequately lit.
2. If material may fall on a worker, overhead protection shall be provided.
3. Access to and egress from a work area located above or below ground level shall be by stairs, runway, ramp or ladder.
4. Areas of access and egress shall be kept clear of obstructions.
5. Areas of access and egress shall be kept clear of snow, ice, or other slippery material.
6. Areas of access and egress shall be treated with sand or similar material when necessary to ensure a firm footing.
7. Every shaft shall have a means of access and egress by stairway, ladder, or ladderway for its full depth during construction and when it is completed.
8. A cage or car on a hoist used for transporting workers in a shaft,
 - Shall be at least 1.8 metres high;
 - Shall be solidly enclosed, except for openings for access and egress;
 - Shall have a maximum of two openings for access and egress;
 - Shall have a gate at each opening for access and egress; and
 - Shall have a protective cover suitable to protect passengers from falling objects.



Safe Work Practices / Procedures / Instruction

ASBESTOS

(See also Asbestos Exposure Control Plan)

The owner or the principal contractor must ensure that the WCB receives a Notice of Project at least 24 hours before beginning work on the following types of projects:

- Removing, encapsulating or enclosing friable asbestos building materials.
- Demolishing, dismantling or repairing any part of a structure or building in which insulating materials containing asbestos have been used or in which asbestos-containing products have been manufactured.

The notification must include:

- name and address of the principal contractor (if any) and the owner,
- address or location of the project,
- starting date and estimated duration of the project,
- a description of the project, including its size, estimated cost of labour and materials,
- detailed written work procedures which will be used to minimize the risk to workers who might be exposed to asbestos material.

NOTE: Notice of Project Asbestos (NOPA) Forms are available from the WCB. A copy of the completed form is to be posted at the job site.

Regulation

General Requirements

6.3 Exposure control plan

(1) If a worker is or may be exposed to potentially harmful levels of asbestos, the employer must develop and implement an exposure control plan meeting the requirements of [section 5.54](#).

(2) To ensure adequate coordination of the overall plan, the employer must ensure that it is administered by a properly trained person.

What is Asbestos?

Asbestos is a naturally occurring material once used widely in the construction industry. Its strength, ability to withstand high temperatures, and resistance to many chemicals made it useful in hundreds of applications. However when asbestos is inhaled, it can be harmful and lead to the following diseases:

- asbestosis
- lung cancer
- mesothelioma (cancer of the lining of the chest and/or abdomen).



Safe Work Practices / Procedures / Instruction

Asbestos Recognition

Asbestos is the generic name for a group of naturally occurring fibrous minerals. Asbestos colour may range from white to a pale yellow, green or blue. Asbestos fibres are very harmful to the lungs. They may cause lung scarring (asbestosis), lung lining scarring (pleural scarring), cancer of the lung lining (mesothelioma) and lung cancer.

Time lapse before the disease becomes evident may be 20-40 years. Workers who smoke have a 10-15 times greater risk of lung cancer from asbestos exposure than workers who do not smoke. The high strength, flexibility, heat and chemical resistance, and frictional properties of asbestos led to its widespread use in electrical insulation, high strength asbestos cement products, pipe covering, floor tiling and asphalt. A good measure of the hazard posed by asbestos is its friability - the ease with which it can be crumbled or pulverized. Products with "bound" asbestos do not pose a hazard unless they are cut, sawn, ground or sanded.

1. If workers unexpectedly discover a material they believe may be asbestos where they are working (e.g.: inside a pipe chase), they must alert their supervisor immediately.

The supervisor will take immediate actions including:

- alerting workers in the vicinity to the presence of the material,
- removing the workers from the environment where exposure may occur,
- restricting access to the area and posting warning notices,
- contacting an approved asbestos removal contractor to take a sample, and provide an assessment,
- where necessary, coordinating the removal or encapsulation of the asbestos
- filing a complete report with head office.

2. In circumstances where it is necessary that work continue in the hazard area, workers who may be affected by the presence of asbestos will be provided with written procedures and protective clothing and equipment, which must be used.

Note: To remove Asbestos a worker requires knowledge of the type of asbestos, knowledge of the proper choice and use of PPE and Respirators, understanding of containment procedures and knowledge of proper handling, storage and waste removal procedures. For type 3 removals, training is a legal requirement.

DO NOT REMOVE OR DISTURB ASBESTOS CONTAINING MATERIAL. IF YOU ARE INSTRUCTED TO DO SO, STOP WORK AND CONTACT YOUR SUPERVISOR. ONLY LOW RISK ABATEMENT ACTIVITIES WILL BE UNDERTAKEN. HIGH RISK ABATEMENT PROCEDURES WILL BE CONTRACTED OUT.

Asbestos “Low Risk” Work Activity Procedures

Low-risk work activities include working near undisturbed friable asbestos-containing materials. Another example is moving asbestos-containing waste material that is contained within a cleaned, sealed bag and then double-bagged involved in such activities should have some knowledge of the hazards of asbestos and the location of the materials. Supervisors must clearly identify all locations of asbestos containing materials, and ensure that all workers have been instructed in any work procedure restrictions needed to prevent contact with asbestos-containing materials.



Safe Work Practices / Procedures / Instruction

Asbestos “Moderate-risk” Work Activities

Activities that carry a moderate risk of exposure to airborne asbestos fibres include:

- Using hand tools to cut, shape, drill, grind, or remove non-friable manufactured products containing asbestos, e.g., asbestos cement pipe
- Drilling (with wetting agents, or with local exhaust ventilation) through non-friable asbestos-containing materials
- Backing mounting screws out of asbestos cement products and removing the boards or tiles intact
- Buffing floor tiles with a coarse disc
- Collecting asbestos samples for laboratory analysis
- Analyzing samples of asbestos or asbestos-containing materials in a laboratory
- Removing any part of a false ceiling to gain access to a work area (for example, during inspection) when friable asbestos containing materials are, or are likely to be,
- Lying on the surface of the false ceiling
- Removing drywall materials where joint-filling materials containing asbestos have been used
- Removing vinyl-asbestos floor coverings or other non-friable materials where the procedures do not create any friable waste
- Removing an entire piece of equipment or pipe with the asbestos-containing material remaining effectively intact (“wrap and cut” procedure)
- Demolishing a block wall (of cement, for instance) that has asbestos debris in its cavity
- Note: The amount of asbestos contamination found when the cavity is open may change the risk level to high.
- Dismantling a treated enclosure at completion of an asbestos removal project
- Setting up and removing a glove-bag apparatus for the removal of pipe insulation when the insulation is in good condition
- Using a prefabricated glove bag to remove asbestos insulation from piping systems
- Note While the area outside a glove bag is considered a moderate-risk area, the work activity inside a glove bag is considered high-risk; if a glove bag is torn or punctured, the risk level outside the bag automatically increases and the site-specific emergency procedures must be implemented.

Clean-up activities that carry a moderate risk of exposure to airborne asbestos fibres include:

- Using a HEPA-filter vacuum to clean ceiling tiles or light fixtures with light to moderate contamination
- Using a HEPA-filter vacuum to clean an area before setting up an enclosure
- Dismantling a treated enclosure at completion of an asbestos removal project
- Setting up and removing a glove-bag apparatus for the removal of pipe insulation when the insulation is in good condition
- Using a prefabricated glove bag to remove asbestos insulation from piping systems
- Note While the area outside a glove bag is considered a moderate-risk area, the work activity inside a glove bag is considered high-risk; if a glove bag is torn or punctured, the risk level outside the bag automatically increases and the site-specific emergency procedures must be implemented.



Safe Work Practices / Procedures / Instruction

Asbestos “Moderate-risk” Procedures

Anyone involved in any moderate-risk work activity must follow written work procedures similar to those described here. To ensure that anyone in or near the work area is not exposed to airborne asbestos fibres, the following must be done:

1. Clearly mark the designated work area boundary by placing barricades, fences, or similar structures around the work area.
2. Place signs around the work area warning people not to enter the work area unless authorized to do so.
3. Wear appropriate protective clothing:
4. Wear a respirator fitted with a “100” (HEPA) filter.
5. Do not use compressed air to clean up or remove dust or materials from work surfaces or clothing.
6. Use polyethylene (poly) drop sheets and seal windows, doorways, and other openings to prevent the spread of asbestos dust to other work areas.
7. Before starting any work that is likely to disturb friable asbestos-containing materials on the surfaces of anything in the work area, clean up the friable materials by damp-wiping or using a vacuum cleaner equipped with a HEPA-filtered exhaust.
8. During the work, clean up dust and waste (wetted if possible) using a vacuum cleaner equipped with a HEPA-filtered exhaust, or by wet-sweeping or mopping.
9. Immediately upon finishing the work, complete the following tasks:
 - Wet drop sheets and barriers.
 - Fold them to contain any remaining dust.
 - Bag or place them in a sealable container.
 - Dispose of them as asbestos waste.
10. Before leaving the work area, complete the following tasks:
 - Clean protective equipment and clothing by damp-wiping or using a vacuum cleaner equipped with a HEPA-filtered exhaust before taking them outside the contaminated work area.
 - Leave any protective clothing worn in the work area in the designated storage area or facility for cleaning, or place disposable protective clothing in a sealable container and dispose of it as asbestos waste.
 - Launder non-disposable clothing
11. Place asbestos waste in a sealable container and label the container to identify its contents, hazard(s), and the necessary precautions for handling the waste materials. To prevent any interference with the work activity, do not allow containers of asbestos waste to accumulate in the work area. Remove containers from the work area at the end of each work shift, if not more often, and ensure that the containers remain under effective control if they are stored at the worksite before being disposed of.
12. Before removing asbestos waste containers from the work area, clean their external surfaces by wiping with a damp cloth or using a vacuum cleaner equipped with a HEPA filtered exhaust. Double bagging is a good practice.
13. After completing the work, provide the owner or employer occupying the area with documentation stating that it is safe for unprotected workers to re-enter the work area.



Safe Work Practices / Procedures / Instruction

Asbestos Removal

The preceding and following procedures must be followed when determining if any materials on the demolition site contains asbestos:

1. The employer or contractor is responsible for determining if materials containing asbestos are present at the job site before work begins.
2. If asbestos materials are found, only trained and qualified workers must remove and dispose this material before any work begins.

If during work activities, materials are found to contain asbestos, all work must be stopped immediately and must be reported to the supervisor.

Refer to the list below showing possible locations of asbestos.

Exterior Surfaces

- Deck under sheeting
- Cement asbestos board siding & under sheeting
- Roof felt & shingles
- Window putty

Interior Surfaces

- Sprayed-on acoustical ceilings
- Acoustical tiles
- Textured paint
- Heat reflectors (woodstoves)

Appliances

- Refrigerators, freezers, portable dishwashers
- Toasters, slow-cookers
- Ovens, hair dryers (not shown) & portable heaters (not shown)

Electrical Equipment

- Lamp sockets
- Outlet and switchboxes
- Insulation on knob and tube wiring
- Recessed lighting
- Main panel and fuse boxes

Insulation

- Loose blown-in full insulation
- Batt insulation

Built-in Equipment

- Water heaters
- Range Hoods
- Clothes dryers
- Dishwashers

Flooring

- Heat source-covering
- Air duct-lining
- Door and cover gaskets
- Pipe-lagging
- Wall gaskets and lining

Heaters & Piping

- Heat source-covering
- Air duct-lining
- Door and cover gaskets Pipe lagging
- Wall gaskets and lining

Miscellaneous

- Cat box aggregate (sand or clay)
- Fireplace logs
- Asbestos hot pads
- Asbestos gloves



Safe Work Practices / Procedures / Instruction

COMPRESSED GAS CYLINDERS

Compressed Gas Cylinders Protocol

All workers must take special precautions when working with and around this kind of equipment. Some general rules for consideration are:

1. Gas cylinders, when not in use, must be stored outdoors and in locked designated area(s).
2. Different gases should be stored separately and isolated from other flammables, such as gasoline, solvents, oil and lumber.
3. Keep full cylinders separate from empty cylinders.
4. Gas cylinders are to be stored in an upright position, valve capped and secured in position.
5. Cylinders must, where practicable, be kept on end. Cylinders placed in a horizontal position must stand in a vertical position for at least one-hour prior to use.
6. Cylinders must not be placed near excessive heat.
7. Sparks, molten metal, electric current, or flames must not be allowed to come in contact with cylinders or their attachments.
8. A crane or hoist must not be used to transport gas cylinders.
9. A gas cylinder must be adequately secured when taken to a work area.
10. Always use proper fitting wrenches when making connections. Do not use vise grips or pipe wrenches.
11. Check valves for leaks using a soapy liquid around the valve connection.
12. No one shall use compressed air or gas to blow dust from their clothes and no one shall blow compressed air or gas at any other worker.

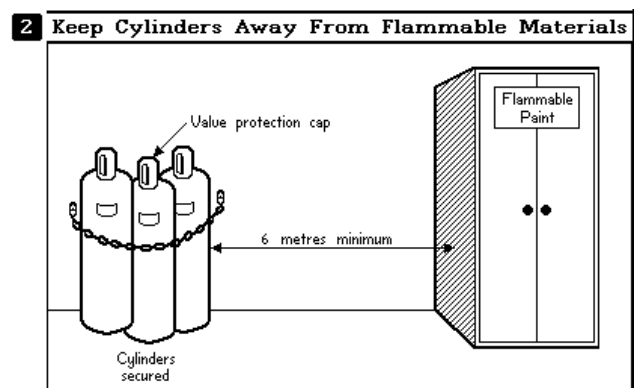
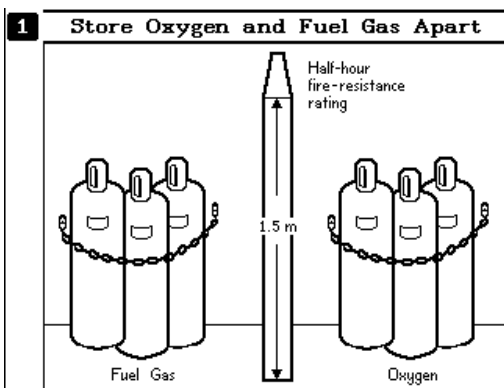
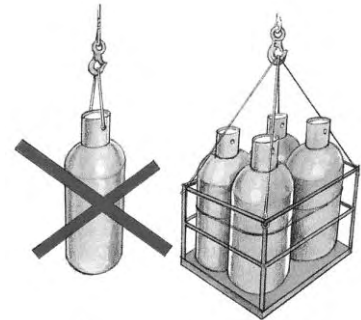



Safe Work Practices / Procedures / Instruction

CONFINED SPACE

Entry into and work in a confined space poses health and safety problems which may include:

- Presence or possible build up of a hazardous atmosphere
- Unexpected movement of equipment or materials
- Engulfment
- Explosive, toxic or oxygen deficient atmosphere

Work within a confined space must be carefully defined and planned ahead of the entry in order to identify all possible hazards and take appropriate preventive action.

Responsibilities

Where confined space work is to be performed, it is the responsibility of senior project personnel to ensure work to be performed has been adequately identified, planned and that all safety requirements have been implemented prior to work commencing.

The responsibility for safety, both at the time of entry and during the entire operation rests with the immediate supervisor. This includes action to continue with the implementation and administration of a safe work plan, ensuring the plan is adhered to and taking all necessary actions to eliminate or control the actual or potential hazards present.

Employee Training / Instruction

In addition to the supervisor training outlined in the H&S program, all supervisors or workers regularly involved in confined space entry shall receive competency training in confined spaces via an accredited organization, or through a program that has been recognized and accepted by Sonic Drilling Ltd. management. This training must be done every two years.

Pre – Job Instruction

The work to be performed shall be under the direction of a competent person thoroughly familiar with the hazards that may be encountered and has received all necessary training.

All workers connected with the performance of the work in the confined space shall before entering, be present at a job meeting to be trained on the hazards they may encounter, how the job will proceed, the precautions required and rescue methods needed in an emergency.

Personal Protective Equipment

Appropriate PPE e.g. clothing, gloves, boots, eye, face and respiratory apparatus shall be worn to meet the requirements of the job.



Safe Work Practices / Procedures / Instruction

Confined Space Entry Procedure

The following steps shall be used each and every time a confined space is entered by a worker. Where a client has specific confined space procedures for specific operations they will be followed so long as they offer equal or better protection.

Safety Planning / Hazard Assessment

When a Sonic Drilling Ltd. employee must enter a confined space, we as the employer shall appoint a competent person to:

Carry out a job hazard analysis (if one has not been completed) of the physical and chemical hazards to which the worker is likely to be exposed both upon entry and during work activities.

Specify the necessary tests to determine whether the worker would likely be exposed to any identified hazards

Job Safety Analysis

To prepare a safe work plan for the work to be performed, outline all actual and/or potential hazards and the controls used to reduce/eliminate them. Use the Sonic Drilling Ltd. job hazard analysis requirements.

Hazards to consider include:

Oxygen enrichment or deficiency	Flammable gas, dust, vapour
Combustible dust	Other hazardous atmospheres
Harmful substances	Hazardous energy, equipment
Engulfment, and/or entrapment	Other hazardous conditions

The procedure must also take the following controls into consideration:

Isolation, lockout, tagging of hazards	Controls of ignition sources
Movement of material	Ventilation and purging
Lighting	Alarms and communication methods
Means of access and egress	Personal protective equipment
Atmospheric testing requirements/frequency	Emergency equipment
Emergency response procedures	Warning signs/barricades
Training requirements	Additional safety procedures



Safe Work Practices / Procedures / Instruction

Energy and Equipment Lockout

The supervisor must arrange for the confined space to be checked to ensure that all blinding, blanking or other effective methods are used to prevent contaminants from entering the confined space.

Where purging is necessary to prevent the development of a hazardous atmosphere in the confined space, water and fresh clean air may be used. When this is completed then a further test shall be done to verify the atmospheric content prior to entry.

Before entry all power driven internal equipment and power sources shall be de-energized and locked out to ensure they cannot be operated.

Ensure adequate lighting and that power sources are intrinsically safe.

Ventilation

Where possible, clean-out doors or any other openings shall be positively locked open and the confined space thoroughly ventilated by a positive method of mechanical ventilation to introduce large quantities of fresh air.

Ensure the air introduced into the confined space is not accidentally contaminated with harmful substances before it enters the confined space.

Continuous ventilation with mechanical ventilation equipment shall be done where necessary to provide secondary protection in the event the work in progress produces contamination, heat or toxic fumes.

Appoint Safety Guard (attendant) / Set Up Communications

Ensure that a person for the guard duties is aware of their responsibilities

The guard is positioned at the confined space entrance and is equipped with the confined space procedure, permit, communications equipment and emergency equipment.

The guard must be capable of rescuing if required (without actual entry) and must be able to communicate constantly with the workers inside either visually or by radio.

The guard does not leave the post unless relieved by a qualified person. The supervisor must be notified by the guard of any dangerous situations that they become aware of. The guard will have basic first aid and CPR training, or be able to immediately contact someone in the vicinity who does.



Safe Work Practices / Procedures / Instruction

Sign In / Sign Out

It is the guard's responsibility to maintain a log system in the immediate area of the confined space. Workers entering the confined space must sign in and out and record the time of entry.

Communications

The supervisor must ensure that an adequate communications system is in place and/or visual contact can be maintained between the guard and the workers in the confined space.

Confined Space Permits

The supervisor will be responsible to ensure that all notifications and permits at the work site have been completed prior to entry. Ensure a written confined space work permit is completed and signed by a competent person and include as a minimum all of the following information:

1. The length of time for which the permit is valid (12 hour maximum)
2. The identity of each worker entering the confined space
3. The activity to be performed by the workers
4. The location of the confined space
5. The results of the atmospheric testing of the confined space both at the time the permit was issued and more often as required
6. The applicable precautions to protect the workers outlined in the plan

Atmospheric Testing

Prior to any entry being made, portable instrumentation for sampling of oxygen concentrations, explosive concentrations and potential airborne contaminants in the confined space shall be used by a competent person to determine atmospheric conditions.

When a job is stopped for any reason and workers have to re-enter after a prolonged work break, then testing shall be done again before entry if work permits are still in place.

Safe Work Practices for Confined Space Entry

Where work is to be carried out in a confined space the following will be considered when completing the Job Safety Analysis / Procedure:



Safe Work Practices / Procedures / Instruction

Types of Confined Spaces

Type 1 – safe atmosphere provided (no immediate atmospheric hazard)

Type 2 – hazardous atmosphere which can be made safe to enter

Type 3 – potentially explosive atmosphere

Type 4 – hazardous / unknown atmosphere on a continuous basis

Type 1 Entry – No Immediate Atmospheric Hazard

No Sonic Drilling Ltd. employee will be present in a confined space unless:

1. There is a means of exit from the parts of the confined space that are accessible to workers.
2. All mechanical equipment in the confined space is disconnected from its power source and locked out.
3. All pipes and other supply lines into the confined space whose contents are likely to create a hazard are blanked off.
4. A guard is stationed outside the confined space.
5. An emergency rescue procedure has been established.

The supervisor or competent designate shall test no less than once per shift and evaluate the confined space before a worker enters it to determine whether it is free of hazard to a worker while the worker is present in it and as often as necessary to ensure that it remains free of hazards.

Type 2 Entry – Atmospheric Hazard May Be Present

No Sonic Drilling Ltd. employee will be present in a confined space in which there is likely to be hazardous gas, vapour, dust, mist, smoke, fume or an oxygen content of less than 19.5% or more than 22.5% unless this section is complied with in addition to the requirements from Type 1 Entry.

The confined space will be purged and ventilated to provide an atmosphere that does not endanger workers, and measures necessary to maintain the atmosphere shall be taken.

When a worker is present in the confined space, a guard (attendant) shall be stationed outside it.

An emergency rescue procedure has been established. If the guard stationed outside the space is not adequately trained in CPR, a worker who is trained shall be readily available.

Type 3 Entry – Explosive Atmosphere May Be Present

No Sonic Drilling Ltd. employee will be present in a confined space that contains or is likely to contain explosive or flammable gas, dust, mist or vapour unless this section is complied with in addition to all requirements for Type 1 and Type 2 Entry.



Safe Work Practices / Procedures / Instruction

A worker may engage in cleaning or inspection activities that do not create a source of ignition in a confined space in which the concentration of explosive or flammable gas or vapour is not likely to exceed 50% of the lower explosive limit of the gas or vapour.

A worker may engage in cold work (work that doesn't generate heat or sparks) in a confined space in which the concentration of explosive or flammable gas or vapour is not likely to exceed 10% of the lower explosive limit of the gas or vapour.

Type 4 Entry – Atmosphere May Be Immediately Dangerous To Health and Life

A worker may be present in a confined space that is not purged and ventilated, or in a space which cannot be made adequately safe through ventilation if the following is done in addition to the requirements of Type 1, 2 and/or 3 Entries.

A worker in a confined space shall use suitable protective breathing apparatus and a full body harness securely attached to a rope whose free end is attached outside the confined space and is being held by a guard/attendant outside the space. The guard/attendant will be provided with an alarm.

A direct means of visual contact and communication between the worker in the confined space and the worker outside it will be provided.

A worker trained in CPR and able to perform rescue operations will be readily available outside the confined space while the worker is inside it. A local emergency response team should also be notified.

Entry into a Type 4 space requires written approval of management.

Job Completion

At the end of the job, a thorough check shall be made by the supervisor to ensure that no tools, equipment or possibly workers have been left behind. Double check and ensure that all personnel are accounted for before leaving the confined space.

Return the work permit to the responsible supervisor for finalization and to ensure that any locks etc. belonging to the crew are removed.

Documentation

All confined space documentation must be maintained at the Sonic Drilling Ltd. office for a period of no less than 2 years upon the completion of the job.

Confined Space Monitors

Confined space monitors can be obtained through Sonic Drilling Ltd. management. The standard atmospheric monitor utilized by Sonic Drilling Ltd. is a (make and model)_____.



Safe Work Practices / Procedures / Instruction

Demolition

Demolition and Pre-Demolition

Pre-Demolition

Before work commences on any new project location, a site survey must be performed by a qualified person(s), to determine the hazards associated with the work to be done during construction. The initial site survey / assessment may take place in 3 steps

1. **Conduct** an initial site survey for hazardous materials such as oil tanks, septic tanks, soap tanks, asbestos and lead paint and other hazardous material which may have accumulated over the years. These assessments should be performed by a qualified hazardous assessment contractor.

- The survey must be written, signed and kept available on site.

2. **Phone: BC One Call** at least 3 days in advance of the work starting, to initiate the locate request for all utility services such as telephone, electricity, and gas both underground and above ground, including high voltage power.

BC One Call Toll Free 1 800 474-6886 or cellular *6886 or locally in Vancouver (604)257-1940.

This will start the process to locate the services from TELUS, Terasen, and BC Hydro. If you have difficulty locating the utility lines, call and ask them to attend and locate the line(s) for you or hire a contractor to locate the services.

3. **Phone or visit** the municipality or city to apply for a demolition permit and apply to have water and sewer connections turned off or removed.

4. Once the utility services have been located, call each of the utilities to have them removed from the site to the satisfaction of the utility owner.

IMPORTANT

When you see the services have been disconnected and before starting work on the site:

- **VERIFY** with the utility supervisor that it is ok to start the demolition, land clearing or excavation, and that the utility service is no longer a hazard to workers and residents. Do not rely on what you see or think may have happened.
- **VERIFY**, directly with a phone call to each of the area supervisors for each utility provider, then document the conversation in your site diary before starting work.



Safe Work Practices / Procedures / Instruction

Demolition Work

- 1 Prior to commencement of demolition work the supervisor must contact management to ensure that a WCB Notice of Project (N.O.P.) has been completed and submitted to the WCB if:
 - total cost of labour and materials for the project exceeds \$100,000; or
 - all or part of the temporary works, except pre-engineered or premanufactured components, are required to be designed by a professional engineer, or
 - the activity involves the removal, encapsulation or enclosure of friable asbestos building materials, or
 - the activity involves demolition, dismantling, or repair of any part of a structure in which insulating materials containing asbestos have been used, or in which asbestos products have been manufactured, or
 - the activity involves a significant disturbance of lead-containing coatings, or
 - activities may expose workers to a significant risk of occupational disease, or
 - the structure to be demolished is:
 - i) a building, silo, chimney or similar structure more than 6 m (20 ft) in height, or
 - ii) a bridge, or
 - iii) an earth or water retaining structure more than 3 m (10 ft) in height, or
 - iv) workers will be working in a compressed air atmosphere or an underground working, tunnel, cofferdam, caisson, or
 - v) the project includes a trench less than 3.7 m (12 ft) wide at the bottom, more than 1.2 m (4 ft) in depth and more than 30 m (100ft) in length that a worker may be required to enter, or
 - vi) the project includes any other excavation more than 1.2 m (4 ft) in depth that a worker may be required to enter.
- An inspection of the site must be undertaken for identification of asbestos, lead or other heavy metal or toxic, flammable or explosive materials that may be handled, disturbed or removed.
- The inspection report referred to earlier must be made available at the work site, including any plans, drawings or specifications, as appropriate, to show the locations of hazardous substances.
- Any hazardous materials identified must be safely contained or removed.
- A Demolition Support Plan, as prescribed by a professional engineer, must be obtained, submitted to the WCB and Head Office and posted at the project location. (NOTE: If the nature and method of demolition will not endanger workers and the stability of adjoining grounds or structures will not be compromised, an engineered plan is not required.)
- The Plan must include a schedule, based on the stages of demolition, for installation of the support system components. (NOTE: The temporary support system may be required to support the weight of building materials that remain on the floor as well as any equipment or machinery involved in the demolition activities.)
- All potentially hazardous services (hydro, gas, water, sewer) must be disconnected.
- All glass and sash must be removed if it places workers at risk.



Safe Work Practices / Procedures / Instruction

- 2 Where practicable, demolition must proceed from top to bottom of the structure.
- 3 If hazardous materials that were not previously identified in the pre-job inspection are discovered during demolition work, work must cease until the materials are contained or removed.
- 4 Before demolishing interior or exterior walls within 3 m (10 ft) of any opening in a floor immediately below, the hole must be securely covered and marked. standard symbol for marking covers for floor openings is a large Ø in red or orange paint) or workers must be removed from the lower levels and prevented access until after the walls are demolished. Walls must not be left standing in an unstable, dangerous condition.
- 5 Materials and debris from the demolition work must be promptly removed from the work location. If such material and debris is to be thrown from the building, the drop location must be barricaded against entry (structural members must be lowered rather than dropped from the building).
- 6 Chutes provided for removal of masonry and other rubble and debris must be enclosed and gates or stops provided at each point of entry and discharge. The area of discharge must be barricaded against entry or the chute must empty into a container. Warning signs stating "Danger - Chute – Sliding materials" must be posted adjacent to the chute outlet.
- 7 Stairways and handrails must be left intact until they are no longer required to access a level.
- 8 Work sheds, vehicles, porta-potties and tool boxes must be located away from the hazard of falling materials.
- 9 During demolition the supervisor must ensure:
 - safe access and egress to and from work areas,
 - work areas are arranged to allow safe movement of workers, materials and equipment,
 - floor openings are guarded,
 - handrails and stairways are left intact as long as possible,
 - housekeeping is maintained,
 - temporary lighting is provided.
 - Emergency procedures are developed for:
 - Removal of injured worker
 - Evacuation
 - Fire
 - Accidental exposure to asbestos
 - Spill procedures



Safe Work Practices / Procedures / Instruction

DRUG AND ALCOHOL POLICY

Sonic Drilling Ltd. is committed to the health and safety and productivity of all operations on behalf of its employees, customers and the communities in and through which it operates. _____ recognizes that the use of illicit drugs and the misuse of alcohol and medications can limit employees' ability to properly do their jobs effectively, and can have serious negative impact on the health and safety of themselves and others.

The goal is not only to comply with current regulations but to reference the Canadian Model for providing a safe workplace. The _____ provides a program that emphasizes a strong commitment to the health and safety of its employees as well as the safety of the traveling public.

This policy applies to all staff members and contractors when engaged in business on behalf of Sonic Drilling Ltd..

Procedure

The possession of and/or consumption of alcohol, illegal drugs, or the misuse of prescription drugs is strictly prohibited on any location where the Sonic Drilling Ltd. conducts its business. This includes all municipal vehicles, mobile equipment and any other operation performed on behalf of _____.

In order to reduce the risk of unsafe or unsatisfactory performance due to the influence of drugs or alcohol, all staff members must report fit for duty and remain fit for duty throughout their standard workday or shift or when on a scheduled call. No worker shall misuse prescription or non-prescription drugs while at work. If a worker is taking a prescription or non-prescription drug for which there is a potential unsafe side effect, he or she has an obligation to report it to the supervisor.

Testing

When investigating an incident or near miss where alcohol or drugs may have been involved, all employees will be tested where there are reasonable grounds to believe they might be unable to work in a safe manner because of the use of alcohol or drugs. _____ will attempt to exercise reasonable care and precaution to protect the confidentiality of employee drug or alcohol screening results and conduct any investigation, search or test in a manner which respects the dignity and privacy of the individual.



Safe Work Practices / Procedures / Instruction

Refusal to Test

The employer may discipline or terminate for cause an employee who fails to comply with the alcohol and drug work rule. Refusal to submit or an attempt to tamper with a drug or alcohol sample for testing will result in disciplinary action or termination of employment.

Cost of the Policy

Sonic Drilling Ltd. shall pay for all costs associated with this policy.

Test Results

Based on the test results and prior to Sonic Drilling Ltd. making a decision with regard to discipline or termination, the employee shall meet with a substance abuse expert who shall make an assessment of the employee and make appropriate recommendations. The employee must demonstrate compliance with the recommendations of the substance abuse expert, or licensed physician with knowledge of substance abuse disorders, as well as sign an agreement specifying return to work conditions imposed as part of a rehabilitation program and other reasonable conditions set by the employer.

Supervisor / Foreman Responsibilities

Supervisors or foremen are responsible for monitoring worker performance and addressing situations where performance consistently or sporadically falls below the expected level of performance. Performance issues can arise in a worker's career for a variety of reasons. Deteriorating work performance can be caused by a work-related problem (such as a conflict with a team member or uncertainty about job responsibilities or employment security) or by personal problems (such as marital or financial stress or the use of alcohol or drugs). As mentioned previously, it is not the responsibility of the supervisor to determine whether or not a worker's performance problem is a consequence of the use of alcohol or drugs off-site. The supervisor's or foreman's responsibility is limited to monitoring work performance and identifying, documenting and addressing performance problems in accordance with Sonic Drilling Ltd.'s existing discipline policy.

Instead of looking for behaviours that may indicate a problem related to alcohol and drug use, supervisors or foremen should concentrate on identifying and documenting changes in a worker's job performance without making moral judgments or assuming the role of counsellor.



Safe Work Practices / Procedures / Instruction

Worker Responsibility

Both the worker and Sonic Drilling Ltd. have a shared responsibility for safety in the workplace. The Occupational Health and Safety Act imposes a legal obligation on all workers to protect the health and safety of themselves and other workers.

As part of this shared responsibility, workers must:

- have an understanding of the alcohol and drug work rule;
- take responsibility to ensure their own safety and the safety of others;
- ensure they comply with the work standards as part of their obligation to perform work activities in a safe manner;
- comply with the work rule and follow appropriate treatment if deemed necessary;
- use medications responsibly, be aware of potential side effects and notify their supervisor of any potential unsafe side effects where applicable; and
- encourage their peers or co-workers to seek help when there is a potential or actual breach of policy.





Safe Work Practices / Procedures / Instruction

ELECTRICAL AND POWER LINE SAFETY

Energized Power Lines

A worker must be informed of the potential electrical hazards before being permitted to do work in proximity to energized electrical conductors or equipment.

The Project Superintendent or Supervisor/Foreman shall follow the following procedure if contact with an energized power line occurs:

1. If the machine is still in contact with an energized wire, inform the operator to stay in the machine and remove all personnel from the immediate vicinity.
2. Notify the BC Hydro Emergency Service by phone (telephone number to be posted at Emergency telephone).
3. Notify the Site Safety Officer who will prepare an incident investigation report.

Disconnection and Lockout

The use of electrical power is a daily occurrence throughout the course of construction. While helpful, electricity may also be dangerous. For this reason we must always exercise caution when working with electrical equipment. Part 10 of WorkSafeBC OHS Regulation 12 for De-energization and lockout procedures must be used. This lockout procedure includes:

1. Portable Electrical Appliances: Disconnect these tools before working on them. If damage is found, report it to the Project Superintendent who will initiate repairs.
2. Hardwire Electrical Appliances: Determine the correct circuit breaker and switch it to the off position. Lock-out the individual circuit breaker by use of a personal padlock. If this is not possible, close and lock the panel door with a personal padlock. Immediately tag the panel identifying whom, when, and why the panel is locked.
3. Electrical Panels: In the event a main electrical panel must be locked-out, a journeyman electrician will be in charge. Keys to the panel or room locked-out are to be held by the electrician and the Project Superintendent to prevent anyone from re-energizing the panel.

REMEMBER:

Always use the required lock out procedure when working on all electrical powered machinery.



Safe Work Practices / Procedures / Instruction

An employee who is ordered to work on equipment or machinery requiring lock out procedures shall be responsible for locking the control devices and removing the locks at the completion of the work. After the lock out procedure has been applied, the employee who applied the locks (to ensure that operation is not possible) must inspect the equipment or machinery.

Low voltage electrical equipment must be completely disconnected and locked out before starting any work on it.

Where it is not practicable to completely disconnect low voltage electrical equipment, work must be performed by a qualified and authorized worker in accordance with safe work procedures which:

- Require the use of appropriate electrical protective equipment, including rubber gloves and cover up, and other necessary live line tools;
- Provide that if practicable, uncontrolled liquid is not permitted close to any worker working on the equipment;
- If applicable, control the use of metal ladders, wooden ladders with metal reinforced rails, metal scaffolds or metal work platforms.

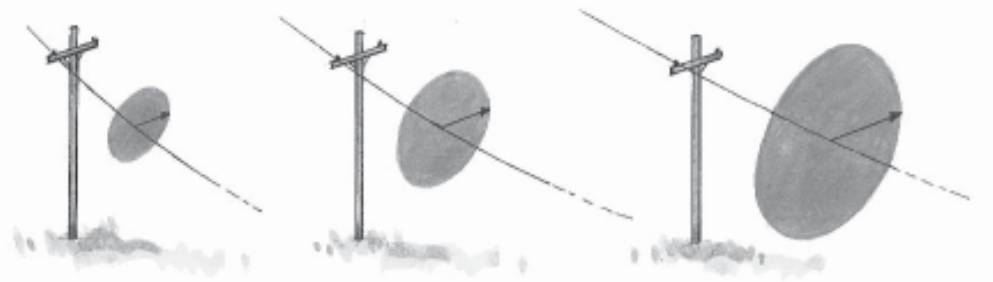

LIMITS OF APPROACH

Voltage	Minimum Distance	
	Metres	Feet
Phase to Phase Over 750 V to 75 kV	3	10
Over 75 kV to 250 kV	4.5	15
Over 250 kV to 550 kV	6	20



Safe Work Practices / Procedures / Instruction

Assurance in Writing

If the minimum distance in the table listed above cannot be maintained because of the circumstances of the work or inadvertent movement of persons or equipment, an assurance in writing (30m33) acceptable to WorkSafeBC and signed by a representative of the owner of the utility system, must be obtained and kept on site. An assurance must state that while work is being done the electrical equipment and conductors will be displaced or rerouted from the work area, if practicable.

If the utility cannot be displaced or rerouted then the assurance must state that the electrical equipment will be isolated or grounded, but if isolation and grounding is not practicable then the assurance must state that the electrical equipment will be visibly identified and guarded. If guarding is used, neither equipment nor unqualified persons may touch the guarding. The letter of assurance must be available for inspections at the workplace. The letter must be posted as close as practicable to the work area and must be made known to all persons with access to the work area.

Assurance Not Practicable

If a worker or workers are exposed to high voltage electrical equipment and the conductors cannot be isolated, rerouted or guarded, then work must not be done within the minimum distances as noted on the Limits of Approach Table (Table 3.17.1) noted above until approval is obtained by the regulatory agency and the following precautions are taken:

- The area within which the equipment or materials are to be moved must be barricaded and supervised to restrict entry only to those workers directly engaged in the work;
- A safety watcher must be designated;
- A positive means must be provided for the safety watcher to give clear, understandable stop signals to the workers in the area and the watcher must give stop signal by no other means.

Where the equipment is in motion in the area in proximity to the energized electrical equipment or conductors, no person other than the equipment operator may touch any part of the equipment or material being moved by it.

No person may move a load or any rigging from its position of natural suspension if it is in proximity to an energized electrical conductor.



Safe Work Practices / Procedures / Instruction

Tools, Cords & Assured Grounding

- All electrical tools and equipment must be grounded or double insulated.
- All electrical tools and equipment must be inspected daily for wear or damage.
- Power cords must be a minimum 3 wire, properly grounded and equipped with CSA approved plug ends, all rated for the electrical load required.
- When used outdoors or in a wet or damp location, portable electrical equipment, including temporary lights, must be protected by a G.F.C.I. Type A unless another approved means of protection is provided.
- An alternative to using a GFCI is to follow the company's Assured Grounding Program. This program requires contractors and their workers to visually inspect their portable power tools and cords on a daily basis, inspecting for defects, cuts, abrasions etc. where the tool or tool requires repair or replacement.
- In addition contractors and their workers are required to test portable power tools and cords using electrical testing devices checking for continuity and polarity of such equipment. These tests must be conducted on a quarterly basis per year. Please see the Site Safety Officer for more details on this program.
- Damaged or defective electrical tools must be returned to the tool room for repair.
- Do not handle electrical equipment unless you are qualified and authorized to do so.
- Temporary electric cords must be covered or elevated. They must be kept clear of walkways or other locations where they may be exposed to damage or create tripping hazards.
- Broken and burned out lamps must be replaced as soon as practicable.
- Energized wiring in junction boxes, circuit breaker panels and similar places must be covered when not being worked on.
- All work areas must have adequate lighting.
- Under no circumstances shall workers stack materials, erect scaffolds, or operate tools and equipment in proximity to power-lines within the limits of approach specified. (Table 3.17.1 - Limits of Approach)
- Sufficient distance shall be maintained to prevent unplanned or accidental movements bringing the worker, tools, equipment or materials within the specified distance. The specified distance required applies to all parts of the equipment including booms, hoisting cables, and any part of the load being raised.
- Employees (other than qualified electricians) and equipment shall not touch or handle electrical guarding.
- Whenever guarding is used, a qualified safety watch (trained and experience journeyman electrician) shall be posted to control the approach of equipment, tools and workers and prevent contact with the guarding.
- When work is being carried out in proximity to energized electrical conductors operating at 750 watts or less, the Project Superintendent shall ensure that any employee performs the work in a manner preventing the contact with the energized conductors.



Safe Work Practices / Procedures / Instruction

ENVIRONMENTAL POLICY

Sonic Drilling Ltd. recognizes the need to conduct business in a manner which protects and sustains the environment. The municipality strives to make environmental considerations part of its business planning and decision-making process.

Sonic Drilling Ltd. endeavours to develop and implement an environmental management system, which will:

- Assure compliance with local, provincial, and federal laws and regulations.
- Evaluate and assess its operations to provide and maintain environmental protection.
- Assess potential environmental risks of products, processes, and operations.
- Evaluate and monitor environmental performance.
- Provide education and training to employees.
- Maintain an effective communication and reporting system.
- Focus on pollution prevention and waste reduction.
- Set annual environmental goals and objectives to encourage improvement.

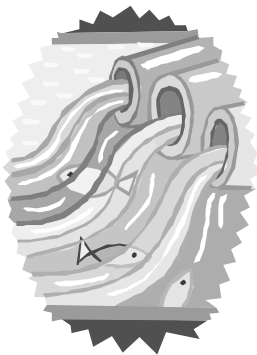

The employees all share environmental management responsibility.



Safe Work Practices / Procedures / Instruction

ERGONOMICS POLICY

The objective of the Sonic Drilling Ltd. policy is to eliminate or minimize risks leading to musculoskeletal injuries (MSI's) at work and comply with the Workers' Compensation Board of B.C., Occupational Health and Safety Regulation, Ergonomics (MSI) Requirements, Part 4 section 4.46 - 4.53. This section requires that employers assess the workplace and work processes to identify risk factors leading to musculoskeletal injuries (MSI's). Once risk factors have been identified, it is the responsibility of the employer to eliminate or, where it proves to be impracticable, to minimize risk factors contributing to development of MSI's.

Policy

Sonic Drilling Ltd. aims to provide a healthy and safe work environment for its employees by ensuring that risk factors that may contribute to the development of MSI's are identified, assessed and eliminated or mitigated.

Objective

This policy establishes a requirement for all departments at Sonic Drilling Ltd. to prevent work-related MSI's by ensuring that the workplace has been assessed for risks leading to musculoskeletal injury and by requiring that appropriate mitigating actions are implemented.

Ergonomic workspace design standards are established in consultation with company Joint Health and Safety Committee.

Responsibilities

Departments/Departmental Supervisors

Departments and Supervisors budget for and provide workstations, equipment and tools necessary to address employee ergonomic requirements.

Supervisors

Will consult with EHS and may request EHS to undertake an ergonomic assessment, when:

- an employee reports an occurrence of MSI;
- the supervisor suspects that an employee has developed a sign or symptom of MSI;
- the supervisor suspects that risks that may contribute to MSI's are present in the work area;
- choosing furniture, equipment or tools, that vary from established university standards; and
- planning, designing or renovating workspaces that may not conform to ergonomic standards.





Safe Work Practices / Procedures / Instruction

Supervisors shall

- review ergonomic requirements with your company and, in the case of a medical request for workplace accommodation, also consult with the Return to Work/Disability Management Co-ordinator;
- implement ergonomic changes necessary to prevent, eliminate or mitigate risk(s); and
- ensure that employees receive training and education in the ergonomically correct use of furniture, equipment and tools.

Employees shall

- follow established safe work practices and participate in ergonomic training and education;
- report to their supervisors all MSI occurrences;
- report to their supervisors any concerns relating to the ergonomic fit of their workstation, equipment or tools required to do their job; and
- provide medical documentation to their supervisor when requesting medically prescribed ergonomic accommodations.

Purchasing, Planning, Operations and Maintenance Departments

When developing plans, or considering purchases that may not conform to company ergonomic standards, Purchasing, Planning, Operations and Maintenance Departments will consult with the Joint Health and Safety Committee.

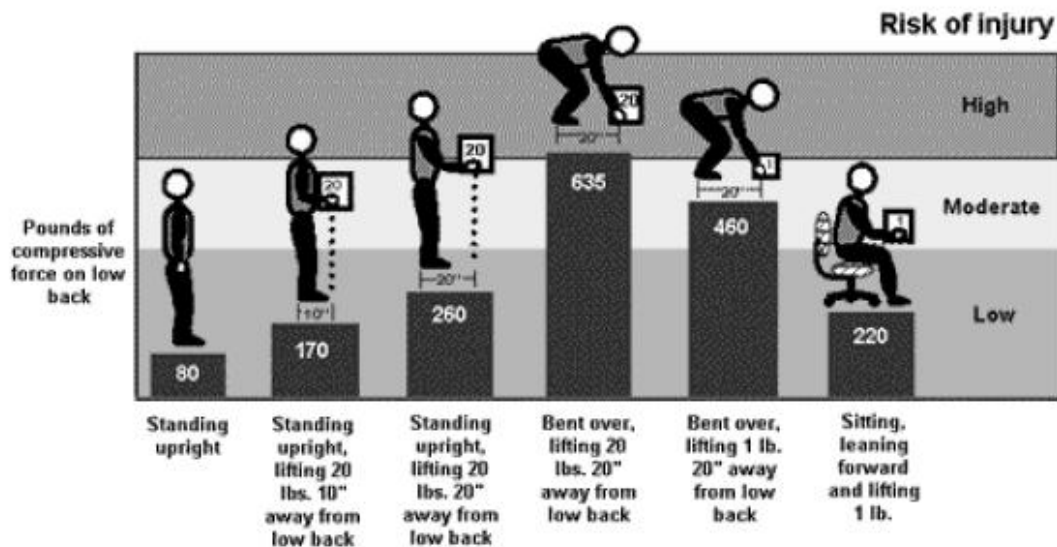



Safe Work Practices / Procedures / Instruction

EXCAVATION AND TRENCHES

Underground Utilities

Before excavating or drilling with powered tools and equipment, the location of all underground utility services in the area must be accurately determined, and any danger to workers from the services must be controlled. Excavation or drilling work in proximity to an underground service must be undertaken in conformity with the requirements of the owner of the service. Pointed tools must not be used to probe for underground gas and electrical services. Powered equipment used for excavating must be operated so as to avoid damage to underground utility services, or danger to workers.

Removal of Surface Encumbrances

Trees, utility poles, rocks and similar objects adjacent to an area to be excavated must be removed or secured if they could endanger workers.

Sloping, Benching and Shoring Requirements

Before a worker enters any excavation over 1.2 m (4 ft) in depth or, while in the excavation, approaches closer to the side or bank than a distance equal to the depth of the excavation, the employer must ensure that the excavation sides are sloped or supported as specified by a professional engineer, or that the sides of the excavation are:

- Sloped at angles, dependent on soil conditions, which will ensure stable faces, but in no case may the slope or combination of vertical cut and sloping exceed that shown in Figure 20-1 as found in WorkSafeBC OHS Regulation;
- Benched as shown in Figure 20-2 as found in WorkSafeBC OHS Regulation;
- Supported in accordance with the minimum requirements of Section 20.85 of WorkSafeBC OHS Regulation;
- Supported by manufactured or prefabricated trench boxes or shoring cages, or other effective means.



Safe Work Practices / Procedures / Instruction

Figure 20-1: Sloping in Lieu of shoring

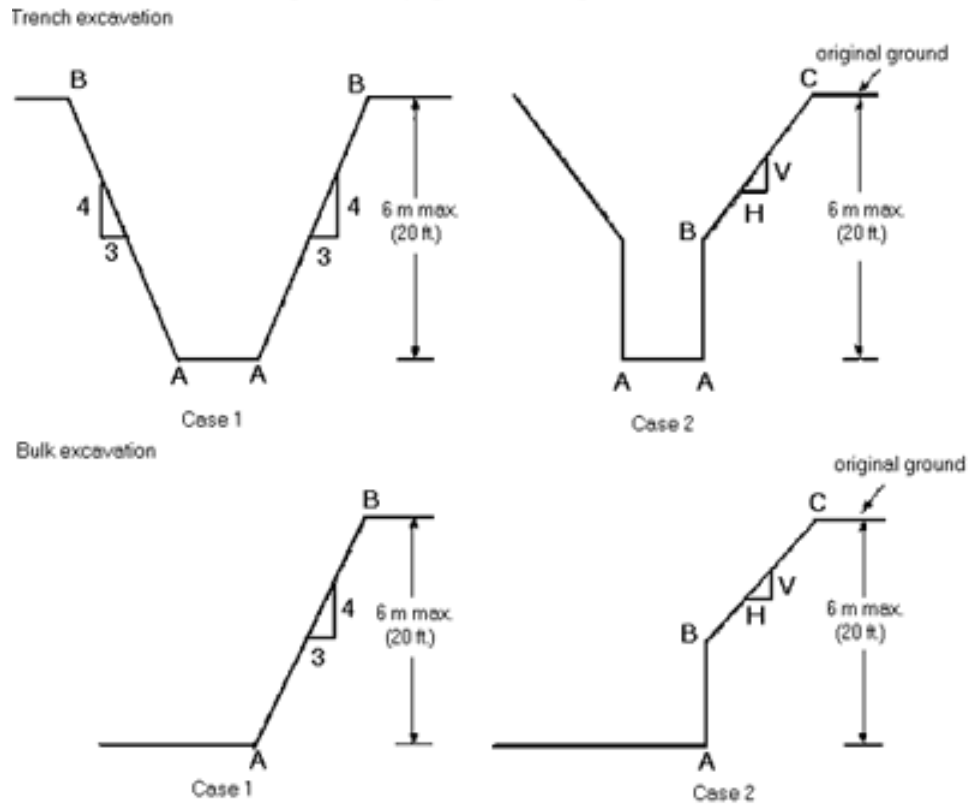



Safe Work Practices / Procedures / Instruction

Figure 20-2: Benching in lieu of shoring

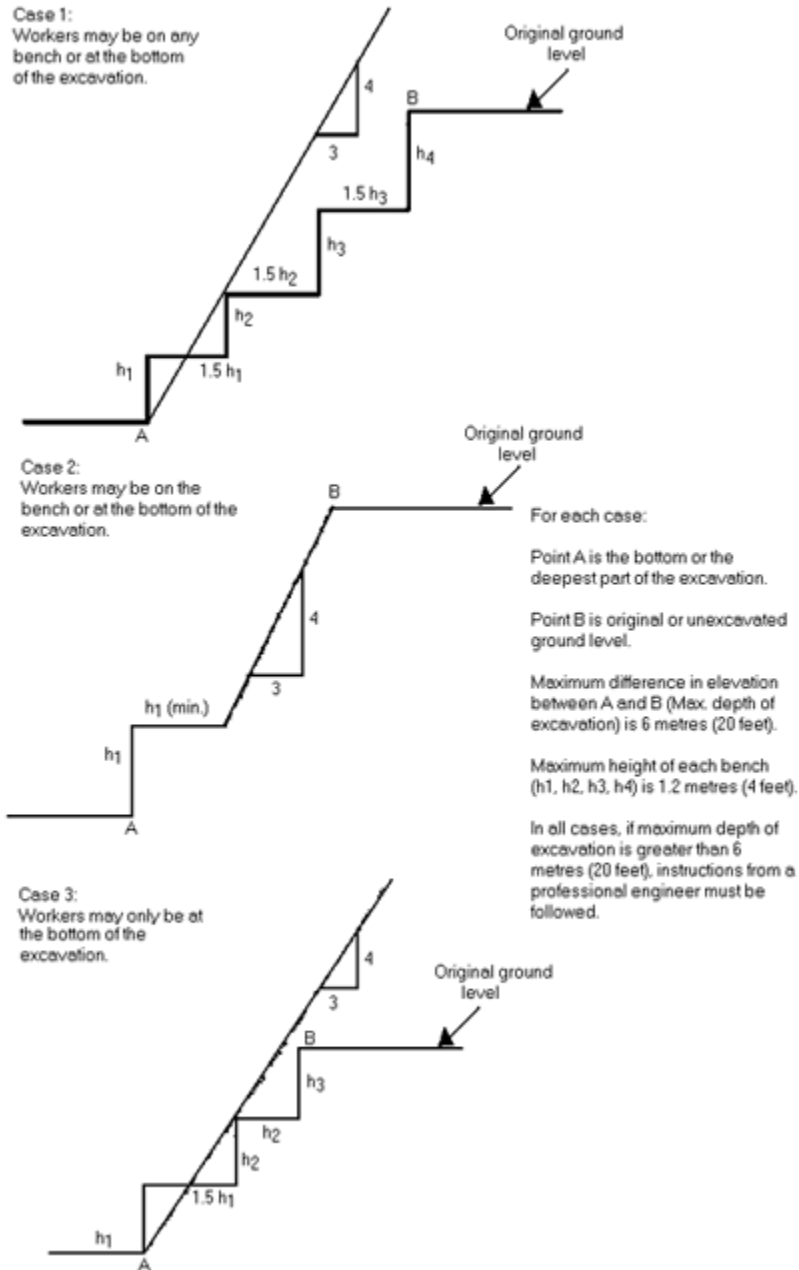



Safe Work Practices / Procedures / Instruction

Figure 20.3 Combined supporting and sloping

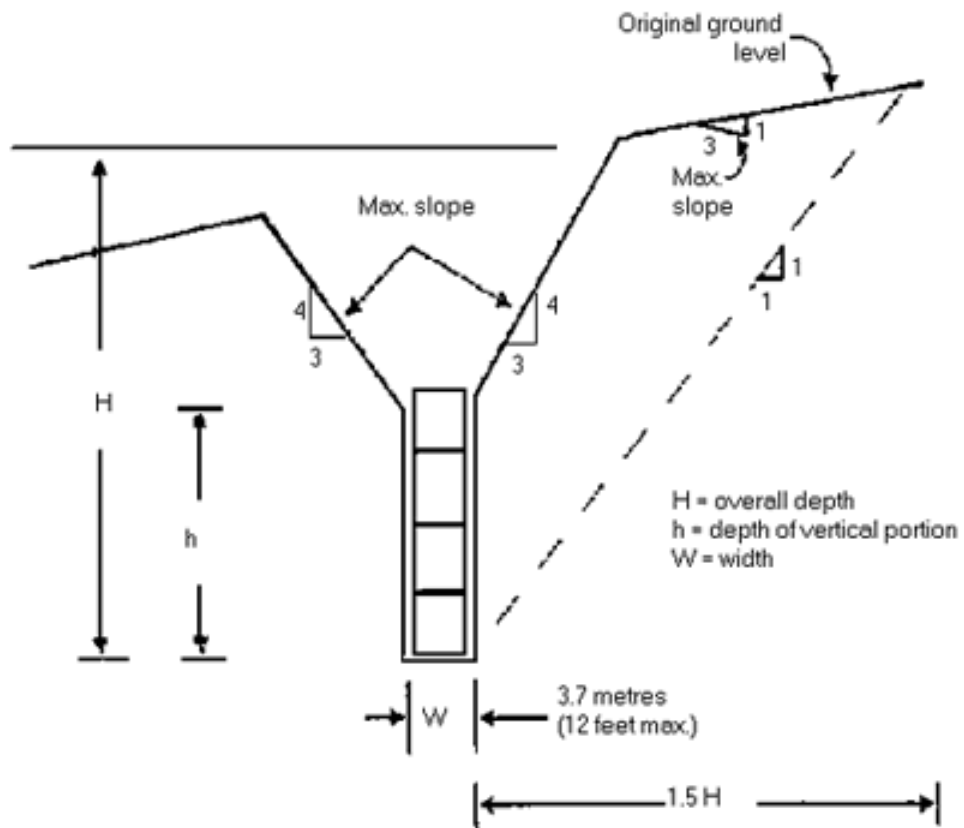

Shoring must be adequate for excavation depth H.
Depth H cannot exceed 6 metres (20 feet).



Safe Work Practices / Procedures / Instruction

Engineering Requirements

Excavation work must be in accordance with the written instructions of a professional engineer if:

- The excavation is more than 6 m (20 ft) deep;
- Support structures other than as specified in Section 20.81 of WorkSafeBC OHS Regulation are used in the excavation;
- An improvement or structure is adjacent to the excavation;
- The excavation is subject to vibration or hydrostatic pressure likely to result in ground movement hazardous to workers; or
- The ground slopes away from the edge of the excavation at an angle steeper than 3 horizontal to 1 vertical.

Spoil Piles

If the average depth of a spoil pile which is adjacent to a supported excavation exceeds 60 cm (2 ft), the selection of the shoring or shielding must take into account the resulting increase in lateral soil pressure.

Excavated materials must be kept back a minimum distance of 2 ft. from the edge of a trench excavation and 4 ft from any other excavation.

Entry and Exit

Safe means of entry and exit must be provided for an excavation a worker enters. If workers are required to enter a trench over 1.2 m (4 ft) deep, the safe point of entry and exit must be located within 8 m (25 ft) of the workers and the excavation must be safely supported or sloped to the entry and exit location.

Where walkways are used to provide access, entry or exit into or over an excavation they must be properly secured to prevent dislodgment. In addition, the open side of an access route into an excavation used by mobile equipment must have a curb.

Guarding

If an excavation is a hazard to workers, it must be effectively covered or guarded. In some cases, excavations may require the need to place fencing systems around the excavation to provide adequate protection, in particular from public access.

Excavation Crossings

Excavations which require the placement of a walkway overtop the excavation must have such walkways measuring no less than 20 in. in width. If the excavation is greater than 4 ft. in depth, the walkway requires the application of guardrails applied to both sides of the walkway as per Part 4 of WorkSafeBC OHS Regulation.



Safe Work Practices / Procedures / Instruction

FALL PROTECTION

Any contractor, when working at a location where workers are not protected by permanent guardrails and where a fall of 7.5m (25 ft) or greater may occur, must have a site specific fall protection plan for the tasks that affect their work before work begins.

A copy of each contractor's Fall Protection Plan/Program must be submitted to the Project Superintendent or Site Safety Officer. Contractors may use Sonic Drilling Ltd. Trade Specific Fall Protection Plan which must be completed by the Contractor Supervisor/Foreman and reviewed and signed by Sonic Drilling Ltd. Site Safety Officer or the Safety Manager as well as his/her employees before commencing work.

General Rules and Requirements

- Workers must have their supervisor's permission to bypass guardrails or barriers erected to prevent them from entering areas where there is a falling hazard.
- In situations where it is necessary to temporary bypass guardrails or barriers, workers must use a lifeline, lanyard and safety belt to prevent them from falling.
- In situations where fall-prevention equipment is inadequate for fall-protection workers must wear fall-arresting equipment.
- Fall-prevention and fall-arresting devices must meet CSA and WORKSAFE BC requirements.
- A fall protection system is to be used by all workers when work is being done at a place;
- from which a fall of 3m (10 ft), or more may occur, or
- where a fall from a lesser height involves an unusual risk or injury
- If the use of a fall restraint system is not practicable, then a fall arrest system must be used. If the use of the fall arrest system is not practicable or will result in a hazard greater than if the system was not used then;
- a control zone is to be used;
- a safety monitor system with a control zone is to be used; or
- Other procedures acceptable to Worksafe BC Safety Standards

Responsibilities

Project Superintendent

- Ensure a Fall Protection Plan is developed on all projects under his/her supervision and that meet the above policy criteria;
- Maintain copies of such plans on site.

Site Safety Officer

- Ensure training documentation is kept on file for all employees that receive fall protection training.
- Reports any unsafe acts or conditions relating to this policy to the Project Superintendent.



Safe Work Practices / Procedures / Instruction

Contractor Supervisor/Foreman

- Ensure all workers under his/her authority receive Fall Protection training from a qualified individual.
- Ensure training documentation is kept on site and is made available to Sonic Drilling Ltd. upon request.
- Ensure that the proper safety equipment is available.
- Ensure that the required safety equipment is regularly inspected and maintained.
- Ensure workers under his/her authority sign and adhere to the Fall Protection Plan.

Workers

- Receive training in and adhere to the project Fall Protection Plan/Procedures.
- Report to the Supervisor/Foreman any non-compliance of the Fall Protection Plan/Procedures.

Danger Areas

Elevator shafts, scaffolding, perimeter slab edge, ladders, powered mobile equipment, leading edge work, floor openings, roof tops and any other area where a fall from 10 feet (3 m) or greater, or when a fall from a lesser height involves a risk of injury greater than the risk of injury from the impact on a flat surface.

The danger area extends 6.5 ft (2m) back from any unprotected edge plus the height of any elevated work platform such as stilts or a ladder. For example, a worker on 2 ft. stilts must have a third guardrail 2 ft. above the normal 40" – 44" guardrail. The preferred method of fall protection is guardrails. Whenever possible, danger areas including floor openings will be protected by proper guardrails.

Obligation to Use Fall Protection

Unless elsewhere provided for in the Sonic Drilling Ltd. Health & Safety Program, an employer must ensure that a fall protection system is used when work is being done at a place:

- From which a fall of 3 m (10 ft) or more may occur;
- Where a fall from a height of less than 3 m involves a risk of injury greater than the risk of injury from the impact on a flat surface;
- If the use of a fall arrest system is not practicable, or will result in a hazard greater than if the system was not used, the employer must ensure that work procedures are followed that are acceptable to WorkSafeBC and minimize the risk of injury to a worker from a fall;
- Before a worker is allowed into an area where a risk of falling exists, the employer must ensure that the worker is instructed in the fall protection system for the area and the procedures to be followed;
- A worker must use the fall protection system provided by the employer.



Safe Work Practices / Procedures / Instruction

Guardrails on Working Top Decks

It is Sonic Drilling Ltd. policy that the top working formed deck of all concrete low rise / high rise projects or commercial buildings require that orange safety fence be attached to the inside of the guardrails, or the inside of the guardrails have plywood attached to prevent the possibility of a person falling through the openings or material falling over the toe board.

Associated Hazards with Working on the Top Working Deck of a Concrete Building

When a deck is first built for a floor, the plywood is laid out, the bulkhead is built (usually 3 ft or less from the guardrail), the mechanical, electrical and rebar is placed and when concrete is ready to be poured, all additional materials are stored between the bulkhead and guardrails.

This area between the guardrail and bulkhead is often used as a walkway especially during the concrete pour. The tripping hazards on this working deck are many times greater than any other floor. Additionally, the material being stored next to a 4" toe board may fall over the toe board to the ground below, thus the need for safety fence or plywood on guardrails.

Safety Fence; Highly Visible and Heavy Duty Material

The safety fence must be applied to the guardrail with:

- Rebar Wire: Doubled over rebar wire every 4 ft. is a good method. Snow fence and wire reusable; or
- Black electrical cable ties ("zap straps") 14 in. long: Easy, quick application, less labor / material cost.

Selection of Harness or Belt

A worker must wear a full body harness or other harness acceptable to WorkSafeBC when using a personal fall protection system for fall arrest. A worker must wear a safety belt, a full body harness or other harness acceptable to WorkSafeBC when using a personal fall protection system for fall restraint.

Equipment Standards

Equipment used for a fall protection system must:

- consist of compatible and suitable components;
- be sufficient to support the fall restraint or arrest forces;
- meet, and be used in accordance with, an applicable CSA or ANSI standard in effect when the equipment was manufactured, subject to any modification or upgrading considered necessary by WorkSafeBC.



Safe Work Practices / Procedures / Instruction

Anchors

In a temporary fall restraint system, an anchor for a vertical lifeline, or for a lanyard used without a lifeline, must have an ultimate load capacity in any direction in which a load may be applied of at least 3.5 kN (800 lbs), or four times the weight of the worker to be connected to the system. Each vertical lifeline used for fall arrest must be secured to an independent point of anchorage. All manufacturers' installation instructions shall be followed.

In a fall arrest system or permanent fall restraint system, an anchor for a vertical lifeline, or for a lanyard used without a lifeline, must have an ultimate load capacity in any direction required to resist a fall of at least 22 kN (5000 lbs), or two times the maximum arrest force.

Temporary Horizontal Lifelines

A temporary horizontal lifeline system may be used if the system is:

- Manufactured for commercial distribution and installed and used in accordance with the written instructions and drawings from the manufacturer or authorized agent, and the instructions and drawings are readily available in the workplace;
- Installed and used in accordance with written instructions and drawings certified by a professional engineer, and the instructions and drawings are readily available in the workplace; or
- Designed, installed and used in a manner acceptable to WorkSafeBC.

Certification by Engineer

The following types of equipment and systems, and their installation, must be certified by a professional engineer:

- Permanent anchors;
- Anchors with multiple attachment points;
- Permanent horizontal lifeline systems; and
- Support structures for safety nets.



Safe Work Practices / Procedures / Instruction

Inspection and Maintenance

Equipment used in a fall protection system must be:

- inspected by a qualified person before use on each work shift;
- kept free from substances and conditions that could contribute to its deterioration; and
- maintained in good working order.

Removal from Service

After a fall protection system has arrested the fall of a worker, it must:

- be removed from service; and
- not be returned to service until it has been inspected and recertified as safe for use by the manufacturer or its authorized agent, or by a professional engineer.

Section 11.2 of WorkSafeBC OHS Regulation prescribes a hierarchy of choice that **MUST** be followed when selecting a method of fall protection. The selection of method(s) depends on what is practicable and is not a matter of free choice by the employer. What is practicable will depend on the circumstances of each work location at the site and the fall hazard assessment conducted.

Fall Protection Hierarchy

- 1st Consideration** - Guardrails or Equivalent
- 2nd Consideration** - Another fall restraint system
- 3rd Consideration** - Fall Arrest System
- 4th Consideration** - Procedures acceptable to WorkSafeBC to minimize the risk of to a worker from a fall.

Floor Roof and Wall Openings

- All openings must be guarded in order to prevent injury to employees
- The opening may be covered with a piece of 5/8" plywood, secured over the opening, and clearly identified using orange fluorescent paint, marked with a circle with a cross in it. Openings greater than four feet square must incorporate bracing to support the cover.
- The covering must be secured to prevent movement.





Safe Work Practices / Procedures / Instruction

FIRE PROTECTION

It is the expectation of Sonic Drilling Ltd. that every reasonable effort shall be taken to prevent or minimize the risk of fire while conducting construction activities on Sonic Drilling Ltd. projects. The safety of all persons, property, environment and equipment is of utmost importance and shall have the highest priority during any construction phase.

This program encompasses emergency response protocols, guidelines and requirements pertaining to emergency response and fire safety and includes specific guidelines pertaining to hot work performed inside and outside Sonic Drilling Ltd. projects. Requirements under the program shall vary depending on the location, duration and potential hazards identified with a specific task or activity. Hot work may only be undertaken with the express written consent of Sonic Drilling Ltd., and shall be subject to compliance with components of the program. Effective implementation of this program shall ensure that hazards associated with hot work are minimized to the fullest extent.

This program is supplemental to Sonic Drilling Ltd. Site Specific Safety Program and includes specific information pertaining to fire safety measures during the construction phase(s) undertaken on our projects.

In addition to that mentioned within, all construction activities must be conducted in compliance with the rules, regulations, codes and/or bylaws of the authority having jurisdiction, including relative rules and regulations specified within the WorkSafeBC OHS Regulation regarding emergency response, fire protection and public safety.

An Emergency Procedure containing this information shall be posted on the site safety bulletin board.

Responsibilities

Construction Manager – is responsible to provide the workplace all necessary resources required to carry out the objectives of the fire safety plan and procedures noted herein.

Project Superintendent – is responsible to monitor the effectiveness of the fire safety plan, emergency response procedures and ensure all workers on the project comply strictly with the requirements and procedures notes within this plan.

Site Safety Officer – is responsible to conduct day to day inspections of the workplace to ensure practices and procedures regarding context noted herein are being followed. He/she is also responsible to schedule and/or conduct training regarding safe work practices associated with controlling fire hazards and suppressing fires, including conducting periodic practice drills to check the effectiveness of the plan and procedures on site. During the project orientation to new workers, visitors etc. the components of the fire safety plan and emergency response plan will be reviewed to ensure fire safety and emergency response awareness is clearly understood by all on site.



Safe Work Practices / Procedures / Instruction

Worker – is responsible to comply strictly with the requirements noted within this plan, including conducting I tasks in a safe manner as can be reasonably expected to eliminate the potential for fire or injury to occur. Any hazards or observations noted by any worker regarding the threat of fire, explosion or personal injury must be forwarded to their respective supervisor, the Project Superintendent, and/or the Site Safety Officer without delay.

Instructions for Fighting Fire

The best means of fighting fires is to prevent them. Workers are responsible for doing everything they can to prevent fires. Smoking is permitted only in designated smoking areas. Workers must know the locations and types of fire extinguishers in their work area. There are four general classes of fires, and each requires a particular type of extinguishing agent.

- **CLASS "A" FIRES** occur in materials such as rags, paper, wood and trash.
- **CLASS "B" FIRES** arise from the vapour-air mixtures found with flammable liquids such as gasoline, oil, grease, paints and thinners.
- **CLASS "C" FIRES** are electrical fires, or fires occurring in or near electrical equipment, thereby presenting the additional hazard of electrical shock.
- **CLASS "D" FIRES** involve combustible metals (e.g.: sodium or magnesium).

Never attempt to fight any fire where

- The fire is spreading at a rapid pace.
- The fire could block your escape route.
- You are alone.
- Heavy smoke or toxic gases are present.
- An explosion has or may occur due to the nature of the products you are attempting to extinguish (example – propane, gas, oily rags and paint).

Before fighting a fire

- Notify the site of the incident occurring by sounding the alarm.
- Call the fire department. DIAL 911.
- At your discretion, decide if the fire is safe to fight (is it spreading).
- Ensure no hazards to yourself.
- Have an escape route at your back – behind you!



Safe Work Practices / Procedures / Instruction

Using a multi purpose dry chemical fire extinguisher (i.e. ABC)

Remember the word – **PASS**

Pull the pin;

Aim low, pointing the extinguisher nozzle at the base of the fire;

Squeeze the handle.....This releases the dry chemical;

Sweep from side to side.

Hot Work Requirement

Sonic Drilling Ltd. requires that any person performing hot work must keep a fire extinguisher nearby the work area for quick deployment.

Fire Watch

Where required, a designated fire monitor will conduct regular inspections of areas where hot work has been completed.

Fire Safety Plans

A hazard assessment review of the project must be conducted in order to develop a Project Specific Fire Safety Plan, which shall include:

1. An architectural drawing (or equivalent) defining the boundaries of the project area;
2. The location of active fire hydrants within 100 metres of the perimeter of the project;
3. The primary and secondary egress routes from any hoarded area, buildings or structures;
4. The location of first aid facilities, telephones and portable fire extinguishers within the project area;
5. The location of any flammable and/or hazardous material storage areas, along with locations of Material Safety Data Sheets for said materials;
6. Emergency contact information (names and numbers) in the event of an emergency situation arising.



Safe Work Practices / Procedures / Instruction

Fire Fighting Equipment

The amount and type of fire fighting equipment will vary from one construction site to another. The minimum types and amount of equipment in all cases shall be:

1. At least one fire extinguisher shall be located on each floor of buildings under construction;
2. The housing for the fire extinguishers must be painted with fluorescent paint and marked "FIRE EXTINGUISHER";
3. In all cases, the fire fighting equipment shall only be used for its manufactured purpose and shall not be moved without authorization with the exception of an emergency situation arising.

Control Measures

- All "Hot Work" operations must be accompanied with a fire extinguisher positioned nearby in the event of a fire occurring.
- No worker is to leave a work area in which "Hot Work" has taken place until it can be proven that the materials cut or heated are cooled down to the point where they pose no potential threat of fire.
- No "Hot Work" activities will commence above or next to areas known to contain construction debris or materials that are combustible.
- Fuel containers such as those containing gasoline or diesel fuel will be kept sealed and stored in an area away from open spark and/or flame. Signage must be posted noting "Combustible Fuel Stored Here" and make mention of "NO SMOKING". Fuel containers must not be stored inside of building under construction. A separate storage shed should be constructed and placed at least 30 ft from any building, if possible.
- Compressed fuel containers, such as propane bottles must be stored upright and secured in a designated area away from potential heat or ignition sources.
- No materials or debris should be allowed to accumulate for long periods of time where it can or may become a potential fire hazard. Debris must be disposed of in a timely manner.
- Oily rags must be kept in sealed containers and identified as containing such items.
- Materials and/or debris must be stored or disposed of appropriately to reflect the effort put forth to maintain a clean workplace.
- Access/egress routes must remain clear of any/or all debris or obstructions during the entire course of the project.
- WHIMIS products must be contained properly and have with them the appropriate and current MSDS. Products found to be on site without the MSDS will be removed immediately.
- Smoking will not be permitted within any site office or trailer.
- All contractors on this project will be required to supply their own fire suppression systems as required to control fire hazards as specified within this plan.



Safe Work Practices / Procedures / Instruction

FLAMMABLE AND COMBUSTIBLE LIQUIDS

Considerations for flammable and combustible liquids are:

1. Flammable liquids must be stored in special areas, away from heat, spark, flame, and direct rays of the sun, and in a location where flammable vapours cannot be communicated to open flame. Bungs must be screwed tightly into barrels to prevent vapour loss.
2. When flammable liquids must be used or stored inside a building, approved safety cans must be used.
3. The fuel tanks of mobile equipment must not be filled:
 - When the engine is running;
 - While anyone is smoking in or around the vehicle; and
 - While there is any known spark or flame in the immediate area.
4. Volatile or flammable materials must not be carried on a vehicle transporting workers unless such materials are carried:
 - In an isolated compartment accessible only from the outside, or
 - In an inside compartment separated from all persons by a firewall. Gasoline and other flammable liquids may only be transferred from one container to another if steps to prevent static electricity accumulation have been implemented. Static electricity may be controlled through the use of container contact or grounding.
 - Gasoline must be dispensed from the storage container by means of an approved pump.
5. Gasoline must not be used to start a fire.
6. Gasoline and other flammable liquids may only be transferred from one container to another if steps to prevent static electricity accumulation have been implemented.



Safe Work Practices / Procedures / Instruction

GAS LINES

In the event of a gas line rupture, the Project Superintendent or Supervisor/Foreman must follow these procedures:

1. Evacuate all personnel from the immediate vicinity of the break and evacuate nearby civilians if necessary;
2. Extinguish any open flame or other source of ignition;
3. Do not attempt to stop the gas leaking, other than by means of closing the existing gas shut off valve;
4. Call BC Gas emergency service by phone (telephone number must be posted and varies by Municipality);
5. Once the area is safe, the Site Safety Officer and Project Superintendent will contact the Safety Manager and commence an Incident Investigation Report.



Oil and Gas

23.5 Safe work procedures

(1) The employer must identify the work activities or circumstances, including releases of gases, that have caused or may cause significant risk of injury or occupational disease to workers.

(2) The employer must analyze the risks arising out of the work activities or circumstances identified under subsection (1) and implement safe work procedures if the activities or circumstances create a hazard.

(3) The procedures implemented under subsection (2) must state the number of workers involved, the steps to be followed and the safety equipment required.



Safe Work Practices / Procedures / Instruction

GRINDERS

- Always wear eye protection when operating a grinder.
- Remove tie and hand jewellery, confine long hair and roll-up sleeves.
- Adjust and tighten wheel guards in place.
- If a spark guard is installed, adjust it to the correct place.
- Check to ensure that blotters and wheel flanges have been used to mount the wheels onto the shaft.
- Adjust and tighten the tool rest to within 1/8" from the wheel.
- Inspect the wheels to ensure they have a special rating greater than or equal to the grinder's speed rating and that they are in good condition. Cracked or chipped wheels must be replaced.
- Do not stand in line with the wheel when starting the grinder.
- Do not use the side of the wheel when grinding; use the face only.
- Use pliers or a vice grip to hold small items.
- If the wheel vibrates: dress it (on the face only), replace it or replace the shaft bearings if they are worn.
- Allow the object you were grinding to cool before handling it.
- Unplug or lock-out the grinder before doing repairs.
- Never leave a grinder unattended while the wheels are turning.

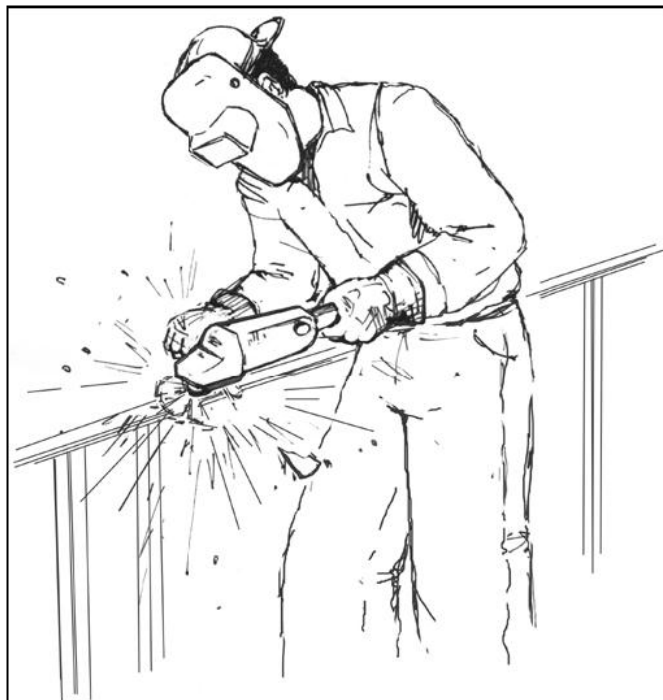



Safe Work Practices / Procedures / Instruction

GUARDRAILS / TOE BOARDS / HANDRAILS

Temporary Removal of Guardrails

If a guardrail must be removed to accommodate work:

- Only that portion of the guardrail necessary to allow the work to be done may be removed, and
- Workers exposed to a fall hazard must be protected by another fall protection system when the guardrail is absent

The guardrail must be replaced:

- When the unguarded area is left unattended, and
- After the work is completed if the circumstances still require guardrails.

The building of, inspection of or disassembling of guardrails will be done in a manner where fall protection is maintained at all times.

Physical Characteristics

- Guardrails must be 40"-44" high.
- Guardrails must have an intermediate rail (approx 20"-22")
- Railings must be attached to the inner sides of support posts or stanchions.
- Posts or stanchions must be placed less than 8 ft. apart, except a scaffold may have posts spaced not more than 3 m (10 ft) apart.
- Toe boards are required if people are working or accessing below the working area above, or where required and noted within WorkSafeBC Regulations.
- Unless otherwise permitted by Part 4 of WorkSafeBC OHS Regulation, guardrails must be installed to withstand a load applied horizontally and normal to the span of the rail, of 550 N (125 lbs) applied at any point along the rail, and a vertical, downward load of 1.5 kN per m (100 lbs per ft) along the top rail, but the horizontal and vertical loads need not be considered to act simultaneously.
- Wooden top rails must be at least 2 in. x 4 in. lumber for a span of up to 8 ft. between supports, and at least 2 in x 6 in. lumber for a span of 10 ft. between supports.
- Wooden mid-rails must be 1 in. x 6 in. or 38 mm x 89 mm (2 in. x 4 in. nominal) lumber.
- Wooden guardrail posts must be at least 38 mm x 89 mm (2 in. x 4 in. nominal) lumber, and must be installed with the narrow dimension facing the open edge.



Safe Work Practices / Procedures / Instruction

A formal inspection of guardrails will be completed daily by the Site Safety Officer.

NO OPENING SHALL BE LEFT UNGUARDED AT ANY TIME

Ensure when building an elevated deck that the guardrails are installed *at least* immediately after the joists and sheathing are set. This method will require the use of a fall protection method. Where practicable, guardrails shall be installed on the exterior walls before standing and bracing them. The guardrail posts must extend at least 3 ft. below the elevated deck and adequately nailed to ensure strength.

Where it is not feasible to have guardrails to protect workers in the danger area "Fall Restraint"/Fall Arrest" equipment must be used.

Guardrail Locations

An area accessible to workers must have guards or guardrails installed in any of the following circumstances:

- If a raised floor, open-sided floor, mezzanine, gallery, balcony, work platform, ramp, walkway, or runway is 122 cm (4 ft) or more above the adjacent floor or grade level;
- On both sides of any walkway over or adjacent to any substance which is a hazard if a worker fell in, or on it, or which is over machinery or work areas;
- Around the perimeter of any open container or containment area such as an open vat, bin, tank or pit which is 122 cm (4 ft) or more in depth and which has sides that do not extend at least as high as required for a guardrail above the adjacent grade or work surface;
- If a stairway ends in direct proximity to dangerous traffic or other hazard to prevent inadvertent entry into the dangerous area.

Exception

Guardrail locations do not apply during the construction, demolition, renovation or modification of a work area provided that:

- Access is restricted only to the workers involved in the activity; and
- The requirements of Part 11 of WorkSafeBC OHS Regulation are followed.



Safe Work Practices / Procedures / Instruction

Toe Boards

- Floor openings, elevated walkways and platforms must have toe boards if there is a danger from tools, materials, equipment and debris falling off the edge of the work surface, or there is a danger of slipping off the work surface due to the environment or work practices being used.
- The top of a toe board must be at least 10 cm (4 in) above the floor or platform, and the space between the bottom of the toe board and the floor or platform must not exceed 13 mm (1/2 in).
- If material is stacked or stored on a platform or walkway, or near a floor opening, toe boards must be increased in height or solid or mesh panels of appropriate height must be installed to prevent the material from falling.

Handrails on Stairways

- Stairs with more than 4 risers must have continuous handrails on:
 - a) any open side of the stairway;
 - b) one side of enclosed stairways 112 cm (44 in) or less in width; and
 - c) both sides of enclosed stairways over 112 cm (44 in) wide.
- The top of a handrail must be 76 cm to 92 cm (30 in to 36 in) above the stair tread, measured vertically from the nose of the tread, and the height must not vary on any flight or succession of flights of stairs.
- A handrail on an open side of a stairway must have a mid rail located approximately midway between the top of the handrail and the nose of the stair tread.
- A handrail must be able to withstand a load of 1.3 kN (300 lbs) applied vertically or horizontally at any point along the handrail.



Safe Work Practices / Procedures / Instruction

TOOLS AND EQUIPMENT

Each foreman must ensure his/her tools and equipment are in good working condition and meets all safety codes and regulations. Tools or similar devices equipped with electrical cords must ensure that the tool is properly grounded (ground prong in place) other than tools that are noted to be “double insulated”

All workers must inspect their tools and equipment prior to the days use. If there are any deficiencies found the tool or other equipment must be flagged and removed from service. Cutting and grinding tools such as mini-grinders must be equipped with a guard as specified by the manufacturer.



General Rules

- Do not use tools for jobs they are not intended for.
- Do not apply excessive pressure on tools.
- Carry sharp tools in a heavy belt or apron rather than pockets, and hang tools at your sides, not behind your back.
- Carry tools in a manner that does not interfere with using both hands on a ladder or climbing stairs on a structure.
- Wear appropriate personal protective equipment (safety glasses, gloves, etc.)
- Maintain tools carefully, keep them clean and dry, and store them properly after use.
- Inspect tools for defects prior to use.
- Replace cracked and broken handles on files, hammers, sledges and screwdrivers.
- Re-dress burred or mushroomed heads of striking tools.
- Exercise extreme caution when using tools near live electrical circuits. Do not use cushion grip handles as a replacement for insulated handles.
- Pull on wrenches and pliers. Never push unless you are using an open hand.
- Face adjustable wrenches forward, and turn wrench so pressure is against permanent jaw.
- Do not increase leverage by adding sleeves to increase tool length.
- Do not cut or chip towards yourself when using cutting tools or chisels.
- Do not re-dress, grind, weld or heat-treat hammer heads.
- Do not use one hammer to strike another.
- Do not use a dull chisel. Re-dress heat-treated tools with a whetstone rather than a grinder.
- Do not use C-clamps to construct scaffolds or platforms for workers.
- Do not hoist with C-clamps. Use special lifting clamps.



Safe Work Practices / Procedures / Instruction

HOUSEKEEPING

Sonic Drilling Ltd. requires a high standard of personal housekeeping on the job. *Sonic Drilling Ltd.* insists on a general “clean up after yourself ” attitude at all times for each tradesperson. Should any trade contractor fail or refuse to perform their own daily clean up, *Sonic Drilling Ltd.* may perform this work and back charge the trade contractor. Considerations for housekeeping are:

- Professional construction workers must have a place for everything and keep everything in place.
- Work areas must be kept clean and free from obstructions at all times. Tools, loose objects, oil, grease and other materials left lying about are hazards.
- Work areas must be cleaned at the end of a shift, immediately after finishing a job, or as necessary.
- Spilled toxic, flammable or corrosive materials must be cleaned up immediately using the method described in the appropriate Material Safety Data Sheet (MSDS).
- Workers must help to keep roads, walks and yard areas clean and depositing refuse in designated containers.
- Materials, tools and equipment must not be stored in stairways, corridors, catwalks, ramps, passageways, exits or overhead.
- Broken glass or other “sharps” must not be disposed of in regular trash containers.
- All materials must be properly stacked and secured to prevent sliding, falling or collapse. Pipe, conduit and bar stock should be stored in racks or stacked and blocked to prevent movement.
- All materials must be stacked or stored in a manner that permits safe access to and egress from a work area.





Safe Work Practices / Procedures / Instruction

LADDERS

Manufactured & Job Built Ladders

A manufactured portable ladder must be marked for the grade of material used to construct the ladder and the use for which the ladder is constructed. For job built ladders follow WCB Standard: LDR 1-2004 Job Built Ladders.

Position and Stability

A ladder must be placed on a firm and level base and be positioned so that the horizontal distance from the base to vertical plane of support is approximately $\frac{1}{4}$ of the ladder length. It must have sufficient length to project approximately 1 m (3 ft) above the upper landing to which it provides access, and be secured to ensure stability during use.

Use of Restriction

If work cannot be done from a ladder without hazard to a worker, a work platform must be provided. A worker must not carry up or down a ladder, heavy or bulky objects or any other objects which may make ascent or descent unsafe. Damaged ladders must be taken out of service immediately.

- Ladders must be inspected for defects prior to use. Ladders with broken rungs, split rails or broken safety feet, frayed or damaged ropes must be taken out of service and reported to a supervisor.
- Ladders must always be placed at least $\frac{1}{4}$ of their length away from the base of the structure they are leaned against. Ladder feet must be placed on a firm, surface. A 2" x 6" board should be placed under ladders equipped with spurs.
- Use ladders of sufficient length. Adding makeshift extensions or working from the top two rungs or steps is prohibited.
- Ladders used for ascending or descending from one level to another must extend at least three feet above the upper landing.
- Metal ladders or wire reinforced wooden ladders must not be used with heat energized electrical equipment.
- Ladders used in locations where they may be struck by workers or equipment in the area, must have a watcher stationed at the bottom. Ladders must not be left standing in such a location when not in use.
- Ladders used in corridors, stairwells or aisles must be barricaded.
- Doorways must be blocked, locked or guarded while ladders are used in front of them.
- Ladders in use must be secured to prevent movement.
- Workers must use suitable hoisting equipment to lift or lower heavy or bulky items.
- No worker is permitted to work from the top two rungs of a single or extension ladder or the top two steps of a stepladder unless permitted by the manufacturer.
- Do not over-reach while working from a ladder.
- Do not use ladders in a horizontal position as runways or scaffolds.
- Do not place a ladder against a window pane.
- Ladders are to be used by one person at a time.





Safe Work Practices / Procedures / Instruction

PERSONAL PROTECTIVE EQUIPMENT (PPE)

(Also See "Personal Protective Equipment Program" - Supplemental Programs and Appendices)

Personal Clothing

Employees shall be properly attired. Clothing appropriate for work to be performed shall be worn. The minimum attire shall include proper shirt, long pants, and approved footwear suitable for construction work. Muscle shirts, cut-off shirts, shorts and running shoes are not suitable attire and shall not be permitted.

Workers must wear clothing that provides ample protection from weather and other hazards. When clothing may come in contact with moving parts of equipment, tools or machinery, the clothing must not be torn, ragged or loose, and pants must not have cuffs. High-visibility apparel must be worn when there is exposure to the danger of moving vehicles. Workers must wear appropriate shirts and long pants on company job sites.

Personal Protective Equipment

Sonic Drilling Ltd. requires full use of protective clothing such as full time use of hard hats and CSA Type 1 approved safety footwear. Sneakers, running shoes, etc. are not acceptable. Gloves, eye protection and hearing protection when required must be used, and include dark glasses for people working with welders, or those adjacent to them.

Hearing Protection

CSA/ANSI approved hearing protection must be worn when the noise level in a work area exceeds the permissible occupational exposure limit, typically noise greater than 85 decibels. All workers on our projects must have their hearing tested annually and carry a valid certificate as proof of testing.

Respiratory Protection

All workers employed on Sonic Drilling Ltd. projects who are exposed to potential hazards associated with airborne contaminants are expected to participate and comply with a project specific respiratory protection program which includes receiving proper instruction and training by their employer on:

- Responsibilities;
- Training;
- Use of Respirators;
- Respirator Selection;
- Dual Cartridge Respirators/Filters;
- Positive/Negative Pressure Fit Testing;
- Inspection and Cleaning;
- User Cooperation and Monitoring;
- Records.



All workers required to wear respiratory protection must be clean shaven where the respirator contacts the face to ensure a proper seal is maintained. No exceptions.



Workplace Hazard Assessment and Control

9.0 WORKPLACE HAZARD ASSESSMENT AND CONTROL

Workplace Hazard Assessments / Job Hazard Analysis

A hazard assessment or job hazard analysis is recommended prior to the start of any new project, task or job. Its purpose is to anticipate, as much as is reasonable, any hazards or hazardous conditions that are inherent or could arise out of a new project, task or job. Once the hazards have been identified, the controls for eliminating or minimizing these hazards can then be determined and implemented. Hazard assessments should also be undertaken when major modifications are made to a project, task or job.

A Job Hazard Analysis System has been designed to anticipate any hazards that may be found in the workplace. A modified version of this system, or one designed to reflect the nature of the hazards found in other types of working environments may also be used. (see "JHA System" - Supplemental Programs and Appendices)

Sonic Drilling Ltd supports the implementation of regular and comprehensive inspections for identification and correction of health and safety deficiencies. As required by the WCB Regulation, inspections will consider work areas under our control as well as company buildings, tools, equipment, machinery, work methods and practices.

Work site hazard assessments and safety inspections are key activities in the prevention of accidents. Their purposes are to:

- identify existing and potential hazards
- increase awareness leading to the prevention of workplace accidents and illnesses
- ensure compliance with standards and regulations.

WorkSafeBC requires that hazards to the safety and health of workers are identified and brought to management's attention. It is the workplace management's responsibility to ensure that the identified hazards are eliminated and, where this is not practicable, to ensure the hazards are controlled and that workers are protected from the hazards.

To meet this requirement, Sonic Drilling Ltd and contractors will provide all necessary resources to ensure that hazard assessments and workplace inspections are effective and must conduct:

- hazard assessments prior to all new projects, jobs or processes, or the introduction of new equipment or hazardous materials.
- regular workplace inspections.
- hazard recognition and safety inspection training for inspectors
- time for inspectors to complete their duties
- established communication channels between inspectors, local safety committee and senior management
- quick action on recommended corrections.

All assessments and inspections shall be documented to demonstrate due diligence.





Inspections

10.0 INSPECTIONS



The inspection process at the worksite is not to be limited to formalized inspections conducted by the project supervisor. The expectation is that there will be other active inspection processes in place.

Informal inspections will be conducted by supervisors on an ongoing basis in their areas of responsibilities. Formal safety inspections shall be conducted and documented by the Site Safety Officer or designate on the job site on a daily basis. Sonic Drilling Ltd Inspection Program comprises of four types of inspections that are structured as follows:

Informal Workplace Inspections

All employees are expected to maintain continual awareness of hazards in their work areas. This is accomplished by supervisors conducting regular walk-through of their areas of authority and by workers checking their work areas prior to commencing work. No formal inspection report is required; however, any detected hazards must be corrected immediately if the task is within the employee's capabilities. If not, the hazard should be reported to the area supervisor or management for correction.

Formal Workplace Inspections

Sonic Drilling Ltd projects will be inspected / audited on a quarterly basis by the company safety coordinator or his designate. Each site inspection will produce a site specific inspection report that will be forwarded and reviewed by each project manager and superintendent respectively. The site management team must ensure that any corrective action arising from these reports is taken so that the hazard is eliminated or controlled. These completed reports shall be compiled into a quarterly safety report to be forwarded to senior management and the Head Office Occupational Health and Safety Committee for review.

Sonic Drilling Ltd will also conduct a yearly (internal) Certificate of Recognition Audit as well as schedule an external audit (once every three years) to maintain the company's COR status and help us measure our progress. (As/Where Required)

Safety Committee Inspections

Safety Committee Inspections are workplace Inspections that are conducted by site safety committee members at least monthly. An Inspection Report is completed, documented and filed and copies sent to the employer (contractor) supervisor of the inspected area, and the safety committee for review. The area supervisor must ensure that corrective action is taken so that the hazard is eliminated or controlled.

Special Inspections

Special inspections take place immediately after a malfunction, accident or after a new work procedure or machinery is introduced. The area supervisor and a worker representative (preferably a safety committee member) conduct this type of inspection. An Inspection Report must be completed and distributed to Sonic Drilling Ltd management and local safety committee for review. In addition, an Accident Investigation may be required for certain accidents (see Accident Investigation section of the program).



Environment / Exposure / Hygiene Control

11.0 ENVIRONMENT / EXPOSURE / HYGIENE CONTROL

Workplace Hazardous Materials Information System (WHMIS)

Sonic Drilling Ltd management will ensure that all hazardous materials stored, used, transported, or disposed of by company personnel are identified and labelled in accordance with applicable legislation. This includes Workplace Hazardous Materials Information System (WHMIS), Transportation of Dangerous Goods (TDG), and the Waste Management Act (WMA). All information regarding hazardous materials will be made readily available to workers exposed to such materials by providing a Material Safety Data Sheet (MSDS) file for all work locations where hazardous materials are used, handled or stored.

Management will ensure all employees using or handling hazardous materials have been trained in hazard recognition, and safe handling, use, storage, transportation and/or disposal procedures as may be required. The information and training regarding hazardous materials will be reviewed on a regular basis.

Supervisory staff is responsible for ensuring that workers who use, handle, transport or dispose hazardous materials have been adequately trained to recognize standard hazard symbols and safe handling/transportation information such as risk phrases, first aid measures and appropriate protective measures as required by law. Supervisory staff is also responsible for ensuring that sufficient labelling, MSDS and protective equipment are available at work locations to meet regulated requirements.

Workers are responsible for following procedures and instructions provided for safe use, handling, storage, transport and disposal of hazardous products. Lastly, workers are responsible for reporting containers that are unlabelled, illegibly labelled or incorrectly labelled. Worksite first aid attendants will maintain an up-to-date controlled material file on site. First aid attendants must be aware of the emergency first aid procedures required for workers who may have been overexposed to hazardous materials at their worksites.

Workplace information includes knowledge of the hazards of the workplace and of the materials used in the workplace. The Workplace Hazardous Materials Information System (WHMIS) is a major response to the worker's right-to-know about safety and health hazards of materials used in the workplace.

WHMIS legislation provides employees, employers and suppliers nationwide with specific vital information about hazardous materials through the key elements of:

- Controlled product labelling
- Material safety data sheets
- Worker education and training programs



Environment / Exposure / Hygiene Control

On the basis of WHMIS and other workplace information, Sonic Drilling Ltd has developed work procedures that ensure worker health and safety. Workers must be educated in hazards and trained in work procedures.

Chemical Inventory

An annual inventory of hazardous materials must be maintained which identifies all hazardous substances and their quantities at the workplace. A chemical inventory includes the chemical name (formula) of the material and the size of its container. Annual inventories allow for the following:

- To check ethers and other chemicals with limited shelf life.
- To remove surplus hazardous chemicals
- To remove chemicals that you would not or have not used in the past 1-3 years.
- To correct incompatible storage.
- To identify which chemicals are present.

WHMIS Program

Sonic Drilling Ltd implements the WHMIS program using information provided through WHMIS as well as other information from the workplace. WHMIS information is in the form of labelling and material safety data sheets. Other workplace information includes knowledge of the hazards of the workplace, use of hazardous materials that depend upon factors such as quantities used, work processes and work location.

To assist in the implementation of this WHMIS program, each employer/contractor will:

- Assign responsibility for program implementation within their company.
- Establish an inventory of controlled products.
- Collect data on products produced in the workplace and determine if they are controlled or not.
- Ensure that WHMIS labelling and data sheets are in place and submitted to superintendent or safety officer.
- Provide workplace labelling where required for all products used within their scope.
- Prepare material safety data sheets and appropriate labels for controlled products produced in the workplace.
- Determine the hazards of controlled products in the workplace.



Environment / Exposure / Hygiene Control

Workplace Controls

Each employer shall establish workplace controls, based on hazard evaluations, which could include:

- Engineering controls: ie/ ventilation, process modification and isolation of the source.
- Administrative controls: ie/ work procedures, storage arrangements, maintenance and time scheduling.
- Personal protective equipment used only in situations where other controls are not practicable.
- Establish emergency procedures
- First aid measures
- Fire-fighting/evacuation measures (notify fire departments of hazardous materials).
- Procedures to handle spills or accidental release.
- Provide worker education and training.

All employers are to ensure their employees have received WHMIS training. All supervisors and employees are to monitor products/materials arriving on site for WHMIS Labels. Product/materials displaying 'WHMIS Labels' indicate they are 'Controlled Products' and must be accompanied by 'Material Safety Data Sheets' (MSDS). These products/materials are **not** to be used until the MSDS is available on site.

Prior to use of the 'Controlled Product', the Supervisor/Foreman will review the WHMIS Label and MSDS and advise his/her employees of the safe work procedures to be followed. The Site Safety Officer shall keep a record of all hazardous products on site.

Copies of MSDS are to be given to the Project Superintendent prior to the use of the product/material in accordance with Government Regulations. This will enable the Project Superintendent to coordinate work procedures for all trades on site. MSDS information records must not be older than three years from the date they were developed.





Environment / Exposure / Hygiene Control

Environmental Protection

Sonic Drilling Ltd is dedicated to act responsibly and demonstrate accountable management of the property and affairs of their projects with regards to protecting the environment. All employers, contractors and individuals associated with each project respectively shall share this responsibility for protecting the environment.

The Purpose of this Environmental Protection Program is to:

- ensure compliance with all applicable environmental regulations at all sites of activity.
- meet all legislated requirements as a minimum standard.
- provide communication and education about environmental issues.
- provide a framework for establishing procedures that will ensure consistent response to environmental issues.
- demonstrate responsibility and due diligence

Worker Responsibilities

The responsibility of every worker, employee, or staff member is to:

- minimize environmental impact by participating in a Reduce, Reuse Recycle program.
- follow established regulatory procedures and policies for the protection of the environment.
- report to their supervisor all accidents/incidents which may harm the environment.

Planning

The environmental impact of all new projects or activities shall be assessed at the Pre-Project planning stage. Ongoing monitoring will be conducted throughout the project by site management. Where possible, efforts will be taken to minimize any adverse impacts. Contractors and/or employers shall follow the guidelines set out by site management with respect to policies and procedures for waste management and environmental concerns.

Handling and Disposal

Disposal of hazardous wastes will be conducted in accordance with all applicable regulation, legislation and/or city bylaws that govern the area. All individuals handling hazardous materials or conducting activities that could impact the environment **must** be trained. Training records are to be documented and maintained up to date.



Environment / Exposure / Hygiene Control

Waste Management

Sonic Drilling Ltd personnel will not knowingly assign any worker to a location or task where there is a hazardous waste contaminant without providing the worker(s) with adequate instruction and direction regarding the hazard and appropriate protection. If waste contaminants pose a serious risk to personnel, then site remediation may be required before work can start. If site remediation is required Sonic Drilling Ltd will work closely with the site owner and Ministry of Environment personnel.

Any hazardous wastes produced on site must be properly identified, stored and disposed of in consultation with site owners and with Ministry representatives for proper disposal of these materials. MSDS for the hazardous materials will need to be available on site.

Workers will be informed of the hazards and proper precautions to take. Workers must follow these precautions and use all required protective equipment when handling or working around hazardous wastes.



Environment / Exposure / Hygiene Control

Exposure Control

If a worker may be exposed to a harmful substance, the employer must ensure that:

- A walk through is conducted to assess the potential for overexposure, taking into account all routes of exposure including inhalation, ingestion and skin contact;
- Reassessment is conducted when there is a change in work conditions which may increase the exposure, such as a change in production rate, process or equipment.

An exposure control plan is required:

1. In general when:
 - Exposure monitoring indicates that a worker is or may be exposed to an air contaminant in excess of 50% of its exposure limit
 - Measurement is not possible at 50% of the applicable exposure limit
 - Otherwise as required by WORKSAFE BC
2. Specifically for possible exposure to:
 - asbestos
 - blood borne pathogens or bio-hazardous materials
 - silica
 - lead
 - extreme heat or cold

Concrete Grinding

An Exposure Control Plan may also be required for concrete grinding, cutting or coring. All concrete grinders must have an attached functioning vacuum system. This is a recognized "Engineering Control" system commonly used in this industry.

Contractors and their employees are expected to follow a hierarchical process regarding this matter which is as follows:

- Elimination
- Substitution
- Engineering Controls
- Administrative Controls
- Personal Protective Equipment



Environment / Exposure / Hygiene Control

Employers / contractors who are required to develop Exposure Control Plans as per regulation must include the following (when applicable):

- Purpose and Responsibility
- Risk Identification Assessment and Control
- Education and Training
- Written Work Procedures
- Hygiene Facilities
- Health Monitoring
- Documentation

Please provide the Project Superintendent with a copy of your Exposure Control Plan prior to beginning the work.

The exposure control plan must be written and include the following:

1. A statement of purpose and responsibilities for assessing the risks and controlling the exposure(s).
2. Details on the identification of the risks, the assessments to be performed and/or that have been performed, and the control measures taken to limit exposure.
3. Details on the education and training that are to be provided.
4. The written procedures that have been produced (as may be required) to inform personnel about hazards and establish safe work methods.
5. Details on the documentation that is required (such as records) to ensure that the issues are addressed as required by regulation and good management practice.
6. A review, at least annually, and regular updates as may be necessary. This will be done in consultation with the occupational health and safety representative(s) or committee(s)

Specific Occupational Hygiene Initiatives

During the course of projects there will be the need to address certain occupational hygiene health issues on a relatively on-going basis, e.g., noise exposure and hearing conservation program. Other health issues may be a rare or one-time occurrence, e.g., working with or around asbestos. The following guidelines for occupational hygiene initiatives focuses on the common health concerns, with basic information provided on other less frequent health issues for awareness purposes. All personnel must be aware of these issues and initiatives. If for any reason you feel that they are not being addressed as per the guidelines provided, or you have other occupational hygiene health concerns, raise them with your supervisor so they can be addressed.



Environment / Exposure / Hygiene Control

Blood Borne Pathogens

First-Aid Attendants and employees are to be aware of potential exposure to Bloodborne Pathogens (blood, body fluids and feces). Every person in the general population is subject to potential exposure to Bloodborne Pathogens. The First-Aid Attendant as well as other "Professional Emergency Workers has occupational "reasonably anticipated exposure" to Bloodborne Pathogens.

Measures are to be taken to limit occupational exposure to blood, body fluids and other potentially infectious materials since exposure could result in transmission of Bloodborne pathogens which could lead to disease or death. The following are basic requirements for First Aid Attendants and all Employees that may come into contact with Bloodborne Pathogens:

1. A type of waterproof gloves must be worn whenever there is the likelihood of hand contact with blood or other potentially infectious material. Disposable gloves must be changed when soiled or damaged. "Many Emergency Workers wear double gloves to reduce the likelihood of blood contact when removing gloves."
2. Masks, Eye Protection and Face Shields are to be worn when there is a potential for splashing or spraying of blood or other potentially infectious material.
3. Gowns and plastic aprons must be disposed of in double plastic garbage bags. These bags are to be tied securely prior to removal and transport to waste containers. Bio-hazardous wastes include any bandages, used first aid supplies, and used disposable wipes and towels.
4. Take particular care not to cut or puncture your own skin with any sharp object that may be contaminated.
5. Use sterile disposable needles and scalpel blades when necessary to remove slivers or other minor foreign objects that are within the scope of treatment by a First-Aid Attendant.
6. Absolutely Ensure Sterilization of any first aid instruments, tools and/or supplies that have been contaminated with blood, body fluids or feces.
7. Hands must be washed after gloves are used.
8. In the event of direct body contact with blood or other body fluids: Immediately wash skin with germicidal soap and running water and then apply a liberal coating of alcohol gel.
9. Complete an Accident Report Form and make an entry in the Accident Records.
10. Arrange an appointment to see your physician or other health care professional should you desire blood testing.
11. Any specific eye, mouth, other mucous membrane or non-intact skin contact with blood or other potentially infectious materials is considered an exposure incident. Follow the steps outlined above. Prompt medical attention and blood testing is recommended.



Environment / Exposure / Hygiene Control

Lead

Lead is an element that has been used in many forms over a number of centuries. It is most commonly encountered in the construction industry as lead-based paint. Lead compounds include metallic lead, lead alloys, lead oxide, and lead sulphate. Lead is still used industrial paints (e.g., red lead oxide primer).

Respiratory Protection

Protecting workers from hazardous substances can be accomplished in a variety of ways:

1. substituting a safer substance;
2. engineering controls (i.e. ventilation systems);
3. administrative controls (i.e. scheduling or worker rotation); and
4. personal protective equipment (i.e. gloves and respirators).

Personal protective equipment is generally considered by WORKSAFE BC to represent the last line of defence and will only be utilized after considering and discarding the practicality of the other methods.



- See our Respiratory Protection Plan In [“Supporting Programs”](#)

Temperature Extremes – Cold

Assessing for exposure to cold temperatures is very similar to the methodology used to assess exposure to heat extremes. The need for assessment is entirely dependent upon the temperatures that the personnel will be exposed to, and whether or not there is a danger of the occurrence of either:



- a) Hypothermia** – a lowering of the body core temperature below 36°C. Personnel are most often at risk of hypothermia in conditions when they are wet, the ambient temperature is near or below 0°C, and they are exposed to a wind. Submersion in cold water can bring on severe hypothermia very rapidly.
- b) Frostbite** – a freezing of parts of the body. The face, hands and feet are the body parts most easily affected. There is a danger of frostbite if temperatures are below -1°C and flesh is unprotected. Contact with cold surfaces in sub-zero temperatures can cause frostbite to occur very quickly.



Environment / Exposure / Hygiene Control

To determine the appropriate course of action when evaluating cold exposure:

1. Determine if personnel will be exposed to conditions that may result in either hypothermia or frostbite. If not, then cold stress is not an issue. If so, go to step 2
2. Determine if the cold exposures will be below -1°C and have the potential to result in frostbite. If yes, then determine under what conditions, time of year, weather conditions, work areas, tasks, and personnel affected, etc. that this exposure may occur.
3. Determine under what conditions hypothermia is likely to be an issue. Include the time of year, weather conditions, work areas, tasks, personnel affected, etc.
4. Take actions to control the exposure through:
 - engineering such as eliminating the need to work where there is cold exposure, heating the work areas, etc.
 - administrative controls such as work procedures/instructions, work/rest cycles that reduce exposure times, and re-warming especially of the hands when the work requires exposing the hands to cold conditions
 - personal protective equipment such as warm clothing and protection of the face, hands and feet in extreme temperatures
5. Also take the following actions as required by the OHSR and good management practice:
6. Provide a re-warming facility, which can be a heated vehicle
7. Provide eye protection where there is a hazard to the eyes from ultraviolet light, glare or ice crystals
8. Provide opportunities to change into dry clothing if the worker becomes wet or is immersed in cold water
9. Post warning signs in areas where and when there is a risk of cold exposure
10. Educate and train workers & supervisors about:
 - signs & symptoms of cold related disorders
 - appropriate clothing for work in cold environments
 - proper re-warming procedures
 - good eating and drinking practices for maintaining body heat in cold environments
 - safe work practices for the work that is to be performed
 - responsibilities for leaving cold environments at the first signs of a cold related disorder
 - methods to reduce the effects of working in a cold environment including steps to be taken to reduce or eliminate contact with cold surfaces that could result in frostbite
11. Keep records of the cold stress assessment and education/training provided
12. Remove cold stress victims from the area immediately and provide first aid treatment by a Level 2 or 3 attendant or physician



Environment / Exposure / Hygiene Control

Temperature Extremes – Heat



The need for assessing exposure to heat is entirely dependent upon the temperature in the work area.

To assess the potential risks from heat exposure and determine the appropriate course of action:

1. Assess the work activities that will take place and determine if they will be light, moderate or heavy. Also determine how long personnel will be exposed to the hot environment. This process will give an indication on whether or not further evaluation and controls are necessary. If not, then heat stress is not an issue. If so, go to step 2.
2. Determine if the exposure will be one time, infrequent or a regular occurrence. If it will be an on-going type of exposure an exposure control plan is required as per regulations.
3. Take actions to control the exposure (when not practicable by engineering controls) through:
 - a. administrative controls such as work procedures/instructions and work/rest cycles
 - b. personal protective equipment such as reflective clothing, or air or water cooled clothing
4. Also take the following actions as required by the OHSR and good management practice:
 - a. provide cool potable water close to the work area and encourage frequent water intake
 - b. post warning signs in high heat stress areas
 - c. educate and train workers & supervisors about signs & symptoms of heat related disorders, responsibilities for leaving hot environments at the first signs of a heat related disorder, and methods to reduce the effects of working in a hot environment
5. Keep records of the heat stress assessment and education/training provided
6. Remove heat stress victims from the area immediately and provide first aid treatment by a Level 2 or 3 attendant or physician



Emergency Preparedness and Response

12.0 EMERGENCY PREPAREDNESS AND RESPONSE

WorkSafeBC requires all employers to provide employees with quick and effective response in the event of injuries or emergencies. First aid and emergency preparedness are an important part of the Health and Safety Program.

The purposes of these services are to:

- ensure prompt and effective emergency response
- promote speedy recovery and to minimize the effects of injuries or exposures
- provide workers with assistance when required

The success of first aid and emergency preparedness depends on employees knowing what to do in minor and major emergency situations. Supervisors are required to communicate emergency numbers and procedures to workers during orientation training and to regularly bring up this information during safety meetings. In addition, risks associated with the projects work process and their control measures must also be communicated and understood. Annual emergency and evacuation drills are practiced to ensure awareness and effectiveness of emergency routes and procedures. All training, meetings and drills shall be documented to meet due diligence requirements. Employers will provide all tools and resources required for these programs to be effective.

These include:

- appropriate emergency response plans and equipment
- training and annual retraining of company emergency responders
- time made available to allow key players to complete their duties
- established chain of command for emergency situations.

Site Specific Emergency Preparedness Program

Formalized site specific emergency procedures will be prepared by Sonic Drilling Ltd for each worksite where Sonic Drilling Ltd is the prime contractor or sole contractor working on site. The Site Safety Officer and/or First Aid Attendant will establish the emergency response plan for Medical and Fire Emergencies, which includes the Emergency Response Team. These procedures must be reviewed with all project personnel, which will be the responsibility of project supervisory personnel to do so. Everyone working on Sonic Drilling Ltd projects is responsible for knowing the procedures. Anyone who is unfamiliar with the procedures, must review them, or speak with supervisory personnel for more information.



Emergency Preparedness and Response

First Aid

Sonic Drilling Ltd is committed to ensuring that appropriate first aid is provided as quickly as possible for any injured company employee. We will provide and maintain a first aid program for the purpose of minimising the suffering related to job-related injuries and illnesses, reducing absenteeism, maintaining productivity, and meeting WORKSAFE BC regulatory requirements.

Where required, Sonic Drilling Ltd will provide and maintain first aid services, supplies and equipment as identified by the Workers Compensation Act (WCA) and Occupational Health & Safety Regulation (OHSR). First aid services, supplies and equipment will be made available to all employees during working hours.

In situations where the provision of first aid services, supplies and equipment is not the responsibility of Sonic Drilling Ltd, we will make every effort to ensure that the responsible party makes the aforementioned provisions.

1. Workers who sustain a job-related injury or illness, regardless of seriousness, are required to immediately report it to the first aid attendant for treatment and/or recording, and must also report it to their immediate supervisor. If medical treatment is required, employees are entitled to choose their own medical practitioner. A WORKSAFE BC Form 6A must be completed by any worker injured on the job, and then submitted to the Head Office at the earliest opportunity.
2. The first aid attendant will be in complete charge of all first aid treatment of injured workers until medical aid is available. Supervisory personnel will not attempt to overrule the attendant's decisions relating to first aid or emergency transportation.
3. Injuries that arise as a result of employment with the company will be reported to WORKSAFE BC by submitting WORKSAFE BC Form 7 if any of the following conditions occur:
 - the worker loses consciousness following the injury
 - the worker is transported to or directed to go for medical treatment
 - the injury is one that obviously requires medical attention
 - the worker states that they intend to seek medical attention
 - the worker has received medical treatment for the injury
 - the worker is unable or claims to be unable to return to their usual job, as a result of job induced injury, on any work day subsequent to the day of injury
 - the accident results in or is claimed to have resulted in the breakage of eye-glasses, dentures, hearing aids or prosthetic devices
 - WORKSAFE BC or the worker requests that an Employers Report of Injury or Occupational Disease (Form 7) be submitted to the Board

To help ensure that appropriate first aid and medical treatment is provided, and workers are assigned to work activities compatible with their health, workers will be instructed in how to summon first aid and report injuries, encouraged to take first aid training, required to complete a medical questionnaire after hire and before starting work. First aid records and statistics will be kept for at least 3 years and will be regularly reviewed by management to determine trends and recommend corrective actions.



Emergency Preparedness and Response

Earthquake Plan

As with a fire, it is impossible to determine the type and extent of the damage the building would receive. Unlike a fire, the entire site in and out would be affected. The intent of these guidelines is to offer a preconceived plan of action and to act as a tool for the education of workers. Earthquakes vary in duration, intensity and pattern and are very destructive. Please read and think about these guidelines as you move about your job.

If you are inside the building

1. Stay calm, drop, cover and hold on.
2. Do not attempt to exit the building while the shaking is still occurring.
3. Get to a position of safety; i.e. away from objects that can fall on you and hurt you, away from edges of the slabs or floor openings, sit in an inside corner or other structurally sound point and keep out from under any temporary forms or structures. Do not hesitate, move at once.
4. Do not leave your position of safety until the shaking stops. If you have no position of safety, do what you can to protect yourself. Get down in a forward position and hold your hands over your head clasped together to protect your neck, and keep your hard hat on.
5. After the shaking has stopped, move to the emergency assembly area shown on the site plan and report your name and any injuries. If you are hurt and unable to move, remain calm to conserve energy and call out for help. Rescue teams will be organized to search for the injured. If on the way to the assembly area you find an injured worker, report the location ASAP. Do not move an injured worker as you can complicate injuries. Move only in life threatening situations. Minimize back and neck movement.
6. Be aware of aftershocks as you may have to repeat the above.
7. **Greatest dangers:** Falling Objects, Swinging doors and broken windows, Fires, Electrical Hazards.

If you are outdoors

1. If possible, move to an open area.
2. Assume a position of safety and keep low.
3. Keep out of harms way i.e.: away from stored materials, trees, mobile equipment, gas or chemical storage, motor vehicles, crew and office trailers or any other objects that can fall and crush you.
4. After the shaking has stopped, move to the emergency assembly area and report in with your name and any injuries. If you are hurt and unable to move, remain calm to conserve energy and call out for help. As mentioned before, do not move and injured worker. Get help.
5. Be prepared for aftershocks.



Emergency Preparedness and Response

After the earthquake has ended

The Project Superintendent or his/her designate will ensure:

- Triage and first aid of injured workers has started;
- A head count will be conducted listing the last known location of missing worker;
- Rescue teams will be formed to assist the injured and to search for any missing workers;
- If necessary, hazardous utilities gas/electricity will be located and shut off;
- No worker is to leave the site without authorization by the site superintendent.

Additional Information

This is to prevent further injury. Do not leave for home. Power will be out and traffic lights will be also. Traffic congestion will occur, people will panic and emergency vehicles will be unable to respond to the injured. Have a home plan in advance to give your family its best chance. Guides are available from supermarkets and bookstores. Stay where you are needed until advised by emergency services. If you are not part of the solution, you are part of the problem.

In case of a major disaster, emergency shelter location will be broadcast by Emergency Services Radio. At this time the local authorities will be advised on how to contact family members. If everyone does their part by staying calm, following procedures and direction of Emergency Services, we will all get back to order sooner.



Records and Statistics Policy

13.0 RECORDS AND STATISTICS POLICY

Records

Maintaining current health and safety statistics in a central location is a major part of a good health and safety program. Many policies, procedures, notices, statements, and reports are necessary to fulfill legal and health and safety program requirements. Sonic Drilling Ltd will maintain records and statistics relating to health and safety as required by the Workers Compensation Act (WCA) and Occupational Health & Safety Regulation (OHSR). Good record keeping will be used by Sonic Drilling Ltd management to:

1. Monitor and evaluate the health and safety performance of the company, specific job sites, supervisory personnel and workers.
2. Identify common factors or trends in accidents and incidents to assist in the development of the Accident Reduction Program.
3. Monitor and evaluate the effectiveness of corrective actions

Responsibilities

Workers

- Report all accidents, incidents, first aid occurrences and equipment damage to supervisors.

Supervisors

- Send all relevant health and safety information to the head office and follow up with procedures to prevent subsequent occurrences.

Management

- Maintain all records
- Monitor injury frequency
- Compile information for the annual health and safety review
- Ensure follow up of all action items from the annual review

Each Site Safety Officer will keep accident/incident statistics and have them available upon request.

Please refer to Safety Record & File Management Information for more information and requirements.

This information must include:

- Accident and incident investigation reports
- Inspection records (Company and WCB)
- Disciplinary action records
- First aid treatment records
- Copies of WCB Forms 6A, 7,
- WCB monthly Claims Cost Statements
- Worker medical questionnaire responses
- Right to refuse unsafe work occurrence records
- Worker and subcontractor safety commitments
- Orientation and training records
- Records of management meetings
- Health and safety program review records



Records and Statistics Policy

Statistics

Statistics must be tracked to help determine how well Sonic Drilling Ltd is achieving their health & safety goals. Frequency, severity and average days-lost rates can be used as indicators of the level of success of Sonic Drilling Ltd health and safety program. They show the rate and duration of work-related lost time injuries and illnesses. The following guidelines are provided for producing the required statistics:

1. Work-related injuries and illnesses to be included in calculations are those which require treatment by a physician, with prescribed absence from work beyond the day of illness or injury occurrence.
2. Illness and injury frequency, severity and average days lost rates will be determined each month:
 - Frequency, severity and average days lost rates will be based on all lost time work-related injuries and illnesses that appear on WORKSAFE BC's Monthly Claim Cost Statements.
 - Days charged for illnesses and injuries, for which the disability continues beyond the statement date, will be included in following month's calculations.
 - Injuries or illnesses which occurred over a long period, such as bursitis or tenosynovitis, will be included in the month they are reported.
3. The following formulas are industry accepted methods for calculating work-related lost time illness and injury frequency, severity and average days lost rates:

FREQUENCY RATE

$$\frac{\text{Number of lost time injuries and illnesses x 200,000}}{\text{Total hours worked during the month, year, etc.}}$$

SEVERITY RATE

$$\frac{\text{Total days lost due to work-related injuries and illnesses x 200,000}}{\text{Total hours worked during the month, year, etc.}}$$

NOTE: The 200,000 figure represents 100 workers at 40 hours per week for 50 weeks per year.



Preventative Maintenance Policy

14.0 PREVENTATIVE MAINTENANCE POLICY

All tools, equipment and vehicles must be properly maintained so that workers are not endangered. Construction regulations require inspections of vehicles, tools, machines and equipment before use.

Preventive maintenance is the systematic care and protection of tools, equipment, machines and vehicles in order to keep them in a safe, usable condition limit downtime and extend productivity. We must always be aware that maintenance tasks themselves are potentially hazardous and can result in injury.

A successful maintenance program is:

- well organized and scheduled,
- controls hazards,
- defines operational procedures, and
- trains key personnel.

General requirements for equipment maintenance include:

- Obtaining a copy of the maintenance schedule recommended by the manufacturer.
- Ensuring that maintenance is performed as required.
- Ensuring that the person(s) performing the maintenance are competent (e.g. licensed mechanic).
- Retaining records of maintenance/service conducted.
- Specifying who is responsible for overseeing equipment maintenance and where the records are kept.
- Set up a system for removal and tagging of damaged or defective tools and equipment.

IMPORTANT:

Please also refer to the “EMPLOYEE HEALTH AND SAFETY MANUAL” in section 16.0 for further information on preventative maintenance to all SONIC drilling equipment.



Preventative Maintenance Policy

Tools and Equipment Maintenance Program

Introduction

This section has been included in our safety manual to highlight the importance of proper maintenance as a vital part of a safety program. In addition to ensuring that workers use the tools and equipment properly, it is vital that tools and equipment be properly inspected, maintained, and kept in good repair. Our maintenance program will reduce the risk of injury, damage and lost production.

It is our policy to ensure that all tools, equipment and vehicles are well maintained in order to reduce the risk of accidents or injuries.

1. Only properly trained workers are to use tools, equipment and vehicles.
2. Inspect all tools, equipment and vehicles before using.
3. For vehicles, inspection will consist of doing a circle check.
4. If applicable, maintenance schedules for all tools, equipment and vehicles are to be respected.
5. Each jobsite supervisor is to conduct a bi-weekly inspection of all tools, equipment and vehicles on the site. This inspection is recorded bi-weekly using an Inspection Checklist.
6. If at any time a worker judges that a tool, equipment or vehicle is unsafe for use, they are to properly tag the item and inform the supervisor immediately.
7. Tools, equipment or vehicles that are tagged unsafe shall be either repaired or replaced. Head office shall be informed.

REMINDER: Always use Hand and Power Tools Safely

1. Select the right tool for the job.
2. Keep tools in good condition.
3. Use tools the correct way.
4. Keep tools in a safe place.

Maintenance Personnel Qualifications

The qualifications of maintenance personnel are key to the success of a maintenance program. All individuals who perform maintenance work on company tools shall have the appropriate skills, accreditation and/or certification.

This certification applies both to company employees and to contracted maintenance services.



Preventative Maintenance Policy

Mobile Equipment Maintenance Program

Maintenance Personnel Qualifications

The qualifications of maintenance personnel are key to the success of a maintenance program. All individuals who perform maintenance work on company mobile equipment will have the appropriate skills, accreditation and/or certification.

This certification applies both to company employees and to contracted maintenance services.

Operator Qualifications and Training

All individuals who operate our mobile equipment, cranes, vehicles etc. will have the appropriate skills, accreditation and/or certification. This applies to both company employees and contracted equipment services.

The approval process includes the following:

1. Possession of a valid driver's license appropriate to the type of equipment.
2. Successful completion of a practical operating exam administered by competent and authorized personnel.
3. Vision test to meet the appropriate standard. Vision tests must be conducted by competent and authorized personnel.
4. Hearing test with or without a hearing aid must be adequate for the specific operation. Hearing tests will be conducted by competent and authorized medical personnel.
5. No history of epilepsy or of a disabling heart condition or any other physical disability or impairment.
6. The operator should be trained in the following:
 - their responsibilities to operate the equipment in a safe manner;
 - familiarity and comprehension of safety requirements for the piece of mobile equipment which they intend to operate;
 - manufacturer's operating and maintenance procedures;
 - hand signals and/or other requirements set by the company, owner.



Preventative Maintenance Policy

Records

The maintenance program must contain a recording system. Part of this system should be made up of inventories and schedules. In addition, the recording system should document what maintenance work was done, when, and by whom.

Monitoring

The monitoring functions in a maintenance program fall into two areas.

First, the people responsible for operating and/or maintaining equipment must monitor that equipment to ensure that appropriate checks and maintenance are done.

Secondly, management should monitor the entire program to ensure that it is functioning in accordance with company policy.

Scheduled Inspections and Maintenance

All mobile equipment is to be inspected and maintained according to the following Equipment Inspection Schedule as a minimum. Records of all inspections and maintenance are completed and maintained for review and approval.

Maintenance of equipment, release of lubrication fluids, etc., is performed only in approved areas. Spills and leaks from equipment are cleaned up promptly.

Equipment Inspection Schedule

Type of Equipment	Type of Inspection	Schedule
Cranes – Crawler, Truck, Hydraulic, etc.	Complete inspection and certification	Before put to work and annually
	Critical items, controls, overall functioning	Daily
	Safety device, hooks, cables, electrical	Monthly
	Complete inspection	Every 3 months
	Repair	When failure occurs
	Preventative maintenance	Manufacturer's recommendation
Heavy Equipment	Complete inspection	Before put to work
Dozers, Backhoes	Complete inspection	Every 3 months



Preventative Maintenance Policy

Compactors, Trucks	Repair	When failure occurs
	Preventative maintenance	Manufacturer's recommendation
	Operator's checklist	Daily
Miscellaneous	Complete inspection	Before put to work
Compressors, Welding Machines, Generators	Complete inspection	Every 3 months
	Repair	When failure occurs
	Preventative maintenance	Manufacturer's recommendation
Slings, Shackles, Chokers, Lifting Devices	Deformation, cracks, corrosion, etc.	Daily or before each use
	Regular inspections of all devices	Every 3 months

Pre-Operation Checks

Walk around checks on all pieces of mobile equipment are necessary to ensure the unit is safe to operate both from the personnel standpoint and for the equipment; that is, all fluids must be at the correct level and all components must be intact.

A. Check for personnel in the cab area and around the equipment.

Before the operator commences the pre-start checks, the operator should check the cab area for other operators and others who may be working around the equipment.

B. Visual check

The operator should walk completely around the equipment looking underneath the equipment, in the engine compartment, and in the cab.

C. Brake Lines

Visually check the brake lines for leaks. Check for moisture on the brake line. Report any leaks to maintenance for repair as soon as possible. DO NOT operate equipment with brake leaks.



Preventative Maintenance Policy

D. Steering Assembly

- Check the tie rod ends, pins and keepers, drag links, ball joints, steering rams and hoses.
- Check that all the joints are tight.
- Report any faulty conditions to your supervisor.

Note: Never operate a truck with faulty steering.

E. Front Tires

Conduct the following checks on the front tires:

- Visually check tires for cuts, separations and embedded, nails, or any other foreign material.
- Check for tire bulges at the road surfaces which indicate low air pressure.
- Check the rims for cracks and breaks.
- Check the valve stems for wear and cuts.

F. Front Wheel Lugs

- Check the front wheel lugs each day.
- Report any loose or broken wheel lugs.
- If there are broken or loose, do not operate equipment.
- Report the condition to your supervisor.

G. Front Suspension

Check the front suspension for bottoming out and also check that all fastening devices are in place.



Preventative Maintenance Policy

H. Fluid Levels

Check all the fluid levels at the beginning of the shift with the equipment on level ground. Refer to the manufacturer's requirements to ensure the proper procedure is followed.

If the fluid level is low, notify your supervisor. Do not operate the equipment until the appropriate fluid level is brought up to operational level.

I. Fluid Leaks

Look for fluid leaks while checking the fluid levels. There may be fluid lines or gaskets that are leaking. Make a visual check to see if fluid is running down the side of the engine block or any other areas while the engine is running.

J. Fan Belts, Blower Belts, Alternator Belt etc.

Check that all belts are in place, tight, and in good condition,

K. Air Tanks

Check the following air tanks:

- The Main Air Tank. The operator should drain the tank twice a shift during the winter months and at the beginning of each shift at other times. Take caution when draining air tanks because of the sludge and water that comes out. The tanks should be drained until clean air is visible.
- Front Air Application Tank. The operator should drain the tank twice a shift in the winter months and at the beginning of each shift at other times.
- Rear Air Application Tanks. The operator should drain the tank twice a shift in the winter months and at the beginning of each shift at other times.

All air lines should be checked for any damage or deterioration during the check on air tanks.

L. Hoist Rams

Visually check the hoist rams to ensure that the hoist anchor pins and keepers are in place. Check the condition of the hydraulic hose and look for leaks. Report any concerns to your supervisor.



Preventative Maintenance Policy

M. Main Frame

Visually check the main frame for cracks and report any problems to the supervisor.

N. Lights

Turn on all equipment lights to see they are working properly including; headlights, clearance lights, and back-up lights.

All faulty lights will be replaced prior to using equipment.

O. Glass

Check that the windshield, windows and mirrors are clean and free of cracks.

P. Handrails and Ladder

Check the condition of the handrails and ladder and look for loose handrails or rungs. Report any unsafe conditions.

Q. Wheel Chocks

Ensure that the truck is equipped with two wheel chocks mounted in a readily accessible place.

R. Seat Belts

Check that the truck has seat belts. It is important that the operator should use them.

S. Fire Extinguishers

Every piece of equipment must be equipped with adequate fire extinguishers in good condition. Faulty fire extinguishers must be replaced immediately.

T. Back Up Alarm

Check that the back up alarm is working correctly.



Legislation

15.0 LEGISLATION



The legislation governing workplaces in BC is known as the Workers Compensation Act. The "Act" is the LAW and is common to all workplaces regardless of the type of work being done. The Occupational Health and Safety (OHS) Regulation contains legal requirements that must be met by all workplaces under the inspection jurisdiction of **WorkSafeBC**. Many sections of the Regulation have associated guidelines and policies.

For more information please visit: www.worksafebc.com

In this section we will identify some of the common legislated requirements that can affect the quality of your health and safety program and compliance with the Workers Compensation Act. One section of the "Act" states

"An occupational health and safety program as outlined in section 3.3 must be initiated and maintained."

By each employer that has: **(Part 3.1)**

- by each employer that has
- a workforce of 20 or more workers, and
- by each employer that has a workforce of 50 or more workers.

"In any operation where the workforce is less than that referred to in section 3.1(1) each employer must":

- Initiate and maintain a less formal program based on regular monthly meetings with workers for discussion of health and safety matters
- ensure that meetings are directed to matters concerning the correction of unsafe conditions and practices and the maintenance of cooperative interest in the health and safety of the workforce, and
- maintain a record of the meetings and the matters discussed.

Workers Compensation Act

The Occupational Health and Safety Regulation is adopted under the *Workers Compensation Act*.

Some key sections of the *Act* are described here and provided on this Web site: www.worksafebc.com

- Sections with direct application to the workplace, including the rights and responsibilities of employers, workers, and other workplace parties, are provided verbatim and shown in normal text.
- Sections that deal with administrative provisions, such as administrative practices and regulation-making authority of the Workers' Compensation Board, are summarized and enclosed in boxes. The summaries are provided as a convenient, plain-language reference.

For details, always consult the complete copy of the Act.



Legislation

Occupational Health and Safety Regulation

The OHS Regulation contains legal requirements that must be met by all workplaces under the inspectional jurisdiction of the WCB. This includes most workplaces in B.C., except mines and federally chartered workplaces such as banks, interprovincial and international transportation, telephone systems, and radio, television, and cable services.

The purpose of the OHS Regulation is to promote occupational health and safety and to protect workers and other persons present at workplaces from work-related risks to their health, safety, and well-being. Compliance with the requirements provides the basis on which workers and employers, in cooperation, can solve workplace health and safety problems. The requirements are not an end in themselves, but are a foundation upon which to build an effective health and safety program.

Guidelines

Guidelines for Workers Compensation Act and OHS Regulation

Guidelines are intended to assist with providing ways of complying with the legislation, not to provide exclusive interpretations. Many sections of the *Workers Compensation Act* (WCA) and the Occupational Health and Safety Regulation have associated guidelines.

More background information on policies and guidelines, and on the hierarchy of authority among the WCA, OHS Regulation, policies, and guidelines, is available in "[About Prevention Policy and the OHS Guidelines](#)"

Policies

Policies for Workers Compensation Act and OHS Regulation

On their web site www.worksafebc.com you will find the Workers' Compensation Board (WCB) policies published in the Prevention Manual. The Prevention Manual contains policies of the WCB with respect to prevention matters under the *Workers Compensation Act* (WCA) and the Occupational Health and Safety Regulation.

The [Prevention Manual \(2 MB\)](#) is also provided in Adobe Acrobat portable document format (PDF). The PDF files reflect the current printed manual, and include the most recent updates.

In 1999, the [Workers Compensation \(Occupational Health and Safety\) Amendment Act, 1998](#) replaced the existing occupational health and safety provisions of the WCA with a new Part 3- Occupational Health and Safety. It also repealed the *Workplace Act*.

The *Prevention Manual* was first developed to set out WCB policies under Part 3. The Panel of Administrators subsequently decided that all occupational health and safety policies would be consolidated into this manual. This process will be completed in 2004.

Effective December 31, 2003, other occupational health and safety policies found in the *Policy and Procedure Manual* are no longer Board policy. They are applicable only to historical matters that were conducted prior to this date.



Supplemental Programs and Appendices

16.0 SUPPLEMENTAL PROGRAMS AND APPENDICES

Instructions: Included in your package is a word (doc.) version of this section.

Use the "word" version of this form provided in your package to enter a list of your appendices, forms, and supplemental programs for your company.

Below is just an example. After completing this section, PDF the document and replace the page(s) with this one. Follow the same procedure when updating this section with new documents.

* Ensure you keep the word (doc) separate for future use.

Appendices

- Emergency Procedures

Forms

- Inspection Checklist
- First Aid Coverage
- Safety Orientation
- Emergency Phone Numbers
- Inspection Report

SAMPLE

Programs

List here your supplemental safety plans pertaining to your company and scope of work.

- Fall Protection Plan
- Emergency Response Plan
- Confined Space Entry Plan



Safe Work Practices / Procedures / Instruction

ACCIDENT / INCIDENT INVESTIGATION

Company: _____

Project Name: _____

Date of Incident: _____

Time: _____

Worker's Name: _____

Date of Birth: _____

This was an:

- Accident
- Incident
- Near Miss

Witnesses:

1. _____
2. _____
3. _____

Nature of Injury:

Description of accident:

Primary causes:

Contributing factors:

Recommendations:

Investigated by: 1. _____ 2. _____ 3. _____

Date: _____ Time: _____

Signed by: _____ Position: _____



Safe Work Practices / Procedures / Instruction

CLEAN UP NOTIFICATION

TO: _____

COMPANY: _____

YOU ARE HEREBY NOTIFIED TO REMOVE ALL TRASH AND DEBRIS CONNECTED WITH YOUR WORK IN THE FOLLOWING AREA(S):

FAILURE TO COMPLETE THIS CLEANUP BY
(DATE): _____

WILL RESULT IN **Sonic Drilling Ltd** PERFORMING THE CLEAN UP AND BACK
CHARGING YOUR COMPANY.

YOUR COOPERATION IS GREATLY APRECIATED.

Sonic Drilling Ltd SUPERVISOR: _____

DATE: _____

CONFINED SPACE ENTRY PERMIT

This permit is valid for 8 hours only.

Location and description of confined space	Permit Number:
Purpose of entry	
Date of entry	Date of Expiry
Other permits required (hot work, line breaking, other)	Time of entry
Entry supervisor (print)	Time of expiry
Attendants (print)	
Known and potential hazards in space	
Describe acceptable entry conditions	
Precautions	Operational and protective equipment
<i>(Check and explain where required)</i>	<i>(Check and explain where required)</i>
<input type="checkbox"/> Pre-entry briefing on specific hazards and control methods	<input type="checkbox"/> Ladder
<input type="checkbox"/> Notify contractors of permit and hazard conditions	<input type="checkbox"/> Full body harness
<input type="checkbox"/> Verify adequate confined space training	<input type="checkbox"/> Lifeline
<input type="checkbox"/> Notification to effected depts/persons of service interruption	<input type="checkbox"/> Tripod/hoist
<input type="checkbox"/> Hot work permit required?	<input type="checkbox"/> Area security (warning signs, barricades)
<input type="checkbox"/> Lines blocked or broken	<input type="checkbox"/> Ventilation fan or blower
<input type="checkbox"/> Ventilation Air flush (preliminary or continuous) (Mechanical or Natural Air)	<input type="checkbox"/> Fire extinguisher
<input type="checkbox"/> Communication method (radio, rope signals, visual hand signals, verbal)	<input type="checkbox"/> SCBA
<input type="checkbox"/> Lighting (hazardous location rated or standard)	<input type="checkbox"/> Coveralls
<input type="checkbox"/> Drain space	<input type="checkbox"/> Face/eye protection
<input type="checkbox"/> Traffic barriers/ entrance covers / signage	<input type="checkbox"/> Footwear
<input type="checkbox"/> Other (specify)	<input type="checkbox"/> Gloves (impervious, chemical, leather, other)
Rescue Procedures and Equipment <input type="checkbox"/> Non-entry rescue procedure and equipment in place (Attendant will extract entrant without entering space) OR <input type="checkbox"/> Entry rescue service and equipment ready to effect a timely rescue (considering hazards in space) <input type="checkbox"/> List rescue equipment:	<input type="checkbox"/> Air purifying respirator (specify cartridge type)
	<input type="checkbox"/> Head protection
	<input type="checkbox"/> Fall protection equipment
	<input type="checkbox"/> Communication
	<input type="checkbox"/> Radiation dosimeter(s)
	<input type="checkbox"/> Hearing protection
	<input type="checkbox"/> Respirator
	<input type="checkbox"/> Other (specify)
Notes:	Notes:

Air monitoring data

Attendant air sampling required (continuously or every _____ minutes)

Test For:	Acceptable Values	*Pre-Entry Time/Results	Break Time/Results	Break Time/Results	Break Time/Results
Oxygen	19.5% _{min} – 23% _{max}				
Flammability	Less than 10%				
Hydrogen Sulfide (H ₂ S)	Less than 10 ppm				
Carbon Monoxide (CO)	Less than 35 ppm				
Other					
Test Location		Purpose of Entry (complete back of form for details)			
Dimensions of Space:		Depth:	Width:	Length:	
Sampling Equipment Date Calibrated:	*Pre-Entry Measurements performed by Entry Supervisor/Lead Worker:			Date:	
Authorized Entrants:		Time In	Time Out	Time In	Time Out
1					
2					
3					
4					

Work Authorization

 Building/area/facility manager or designee (print) Date Time

Permit authorization

(must be signed before entry)

 Competent entry supervisor's signature Date Time
 (Signature certifies that precautions and equipment are in place, atmospheric testing shows air acceptable for entry, permit is complete)

Permit cancellation

(must be signed after work is completed)

 Competent entry supervisor's signature Date Time

POST PERMIT AT JOB SITE UNTIL JOB IS COMPLETED

IN CASE OF EMERGENCY, CALL 911

Instructions

A confined space entry permit must be completed for all permit-required confined space (PRCS) entries.

Permit numbering scheme: building number - space number - ddmmyy

Example: **081-03-240109**

- 1) Contact a competent entry supervisor prior to entry to assist in space preparation and permit completion.
- 2) Review the confined space profile and requirements in the Sonic Drilling Ltd CS program.
- 3) Complete the entry permit.
- 4) Prepare the space for entry according to the permit.
- 5) The competent entry supervisor must review the permit for accuracy and completeness, determine if acceptable entry conditions are present, do a hazard assessment, authorize entry, and oversee entry operations and termination.
- 6) Verify that qualified and trained rescue services are equipped and ready to perform a timely rescue, considering the hazards potentially present in the permit space.



Contractor Safety Acknowledgment

I acknowledge that I have received and read a copy of the Sonic Drilling Ltd Company Safety Program and Contractor Safety Information Package.

As a condition of employment or contract between Sonic Drilling Ltd and myself/company, I have read and understood my responsibilities as they are defined in this program and will abide by these rules, policies and procedures as well as any regulations or otherwise governing safety.

I understand that it is my responsibility as an employer to inform/educate/instruct workers under my control on any policies/procedures/regulations with respect to safety while working on Sonic Drilling Ltd projects.

I understand that this program is to be used in conjunction with the Workers Compensation Regulation/Act and if there is a discrepancy between the two, that the WorkSafeBC Regulation will take precedence over this program.

I understand that Sonic Drilling Ltd reserves the right to change or amend the Sonic Drilling Ltd Safety Program at any time.

I understand that any violation to the safety program/policies/procedures or regulation will be cause for disciplinary action or termination of employment.

I acknowledge that I understand the requirements of the Sonic Drilling Ltd. Safety Program and agree to abide by all such requirements.

COMPANY:

EMPLOYEE NAME: (CONTRACTOR)

SIGNATURE: (CONTRACTOR)

**THINK SAFE - WORK SAFE - STAY SAFE ...
WATCH OUT FOR YOUR FELLOW WORKER**



Safe Work Practices / Procedures / Instruction

EMERGENCY PHONE NUMBERS

Location - _____

EMERGENCY DEPARTMENTS	CONTACT PERSON	PHONE NUMBER
Safety Department		
Project Manager		
Site Superintendent		
Fire Department		911
Non Emergency		
Police Department		911
Non Emergency		
Ambulance		911
Provincial Poison Control Centre		1-800-567-8911
Environmental Emergencies		1-800 663-3456
BC Hydro		1-888-769-3766
Terasen Gas (Emergency Number)		1-800-663-9911
BC One Call (Call before you dig)		1-800-474-6886
Waterworks Emergencies		7a-3p: (604) 326-4800 3p-7a: (604) 606-2676
Worksafe BC		(604) 276-3100
Security		



Safe Work Practices / Procedures / Instruction

EMERGENCY PROCEDURES

“ _____ ”

Site Name

In the event of an emergency, the following steps shall be implemented as such:

1. **IMMEDIATELY SOUND THE ALARM** by activating one of the air horns located on the project or contact one of the company representatives via the two-way radio or cellular phone systems established and used on site.

1 - LONG BLAST (approx 5 seconds)	EVACUATE
3 - SHORT BLASTS (approx 2 sec each)	FIRST AID

Dial 911 and report your emergency:

2. Assign a designated person to proceed to the nearest access/egress gate to direct incoming emergency personnel services.

FIRE PROTOCOL (Fire Extinguisher locations indicated on site map)

AT YOUR DISCRETION CONTAIN AND EXTINGUISH THE FIRE IF AT ALL POSSIBLE. IF UNABLE TO CONTAIN, FOLLOW EVACUATION PROTOCOL AND DIAL 911.

EVACUATION PROTOCOL (See safety program map for locations)

SHOULD THE HORN BE HEARD, ALL PERSONS ON SITE ARE TO IMMEDIATELY LEAVE BY THE NEAREST EXIT IN AN ORDERLY MANNER AND MAKE THEIR WAY TO THE MUSTER STATION AND REMAIN THERE UNTIL GIVEN FURTHER INSTRUCTIONS BY EMERGENCY PERSONNEL OR MANAGEMENT.

AT THIS TIME, ROLL CALL WILL BE TAKEN TO ENSURE ALL ARE ACCOUNTED FOR.



Employee Safety Acknowledgment

I acknowledge that I have received and read a copy of the Sonic Drilling Ltd Company Safety Program and Employee Safety Manual. As a condition of employment or contract between Sonic Drilling Ltd and myself, I have read and understood my responsibilities as they are defined in this program and will abide by these rules, policies and procedures as well as any regulations or otherwise governing safety.

I understand that this program is to be used in conjunction with the Workers Compensation Regulation/Act and if there is a discrepancy between the two, that the WorkSafeBC Regulation will take precedence over this program.

I understand that Sonic Drilling Ltd reserves the right to change or amend the Sonic Drilling Ltd Safety Program at any time.

I understand that any violation to the safety program policies or procedures will be cause for disciplinary action or termination of employment.

Date: _____

Employee Name (Sonic Drilling Ltd)

Employee Signature (Sonic Drilling Ltd)

**THINK SAFE - WORK SAFE - STAY SAFE ...
WATCH OUT FOR YOUR FELLOW WORKER**



Safe Work Practices / Procedures / Instruction

AFTER HOURS FIRST AID COVERAGE AGREEMENT

PERSONAL INFORMATION (Please Print)

Name: _____

Company: _____

Phone Number: _____ Cellular: _____

FIRST AID INFORMATION

I am a certified Occupational First Aid Attendant Level: 1 2 3 (please circle)

Certificate expiry date: ___ / ___ / ___ (dd/mm/yy) *Photocopy certificate and keep on file*

PROJECT INFORMATION

Project Name: _____

Date of First Aid Coverage: ___ / ___ / ___ (dd/mm/yy) Start Time: _____ End Time: _____

Number of Workers: _____ Hazard Level: Low Medium High (please circle)

Please initial each:

1. _____ I agree to provide first aid services for the workers to the best of my abilities.
2. _____ I have been given access to the first aid equipment necessary to render first aid.
3. _____ I am aware of the emergency air horn signals: 3 short blasts = first aid
1 long blast = evacuate
4. _____ In the event that I cannot provide first aid on the date specified above, I agree to inform my supervisor or a company supervisor as soon as possible, so that other first aid arrangements can be made.

OFA Signature: _____

Company Signature: _____

INDEPENDENT OPERATOR'S APPLICATION FOR COMPENSATION AND REPORT OF INJURY OR OCCUPATIONAL DISEASE

Please answer all questions and complete this report in ink. Incomplete applications may have to be returned resulting in some delay in the processing of your claim. Please ensure that this report is signed and submitted by mail or fax. You may also wish to use the reverse side of this report or submit a separate letter.

Registration number under which you are registered with WorkSafeBC (the WCB)		Registration number	Location	Classification unit number	Coded by
Type of business		LAST NAME (please print) Mr. <input type="checkbox"/> Ms. <input type="checkbox"/> Mrs. <input type="checkbox"/> Miss <input type="checkbox"/>			
Employer's name (as registered with WorkSafeBC)		First name(s)		Middle initial	
Mailing address		Home mailing address			
City	Postal code	City	Postal code		
Location of plant or project where injury occurred		Postal code	Date of birth	Home telephone number	Marital status
			Month Day Year		Married <input type="checkbox"/> Single <input type="checkbox"/> Other <input type="checkbox"/>
Business telephone number	Occupation	Social insurance number		Height	Weight
				Feet Inches	lb.

6 / 7

1A. Date and time of injury _____, 20____, at _____ A.M. <input type="checkbox"/> P.M. <input type="checkbox"/> OR 1B. period of exposure resulting in occupational disease FROM 20____, TO _____ 20____	8. Were your actions at time of this injury for the purpose of your business? If NO, please explain. YES <input type="checkbox"/> NO <input type="checkbox"/>								
2A. Please describe fully what happened to cause the injury and mention all contributing factors: description of machinery, weight and size of objects involved, etc. OR 2B. in cases of occupational disease, describe when and how exposure occurred, mentioning any _____ gases, vapours, dusts, chemicals, radiation, noise, source of infection or other causes. Please explain fully.	9. Were your actions at time of this injury part of your regular work? If NO, please explain. YES <input type="checkbox"/> NO <input type="checkbox"/> 10. Was anyone else responsible for your injury? If YES, please give name and address. YES <input type="checkbox"/> NO <input type="checkbox"/> 11. Did you have any defect or disability before the injury (lost finger, blindness, deafness, restriction of movement, etc.)? YES <input type="checkbox"/> NO <input type="checkbox"/>								
3. What were you doing when this injury occurred?	12. Have you had any previous pain or disability in the area of this present injury? If YES, please specify. YES <input type="checkbox"/> NO <input type="checkbox"/>								
4. Please state ALL injuries received at this time, indicating right or left if applicable.	13. Did you ever receive a cash award or pension from WorkSafeBC (WCB)? If YES, please give claim number. Do NOT include wage loss payments. YES <input type="checkbox"/> NO <input type="checkbox"/>								
5. Name and address of physician or qualified practitioner who treated this injury. Include telephone number, if known.	14. Did you lose any wages beyond the day of this injury? If YES, please specify date and time you stopped work. _____, 20____, at _____ A.M. <input type="checkbox"/> P.M. <input type="checkbox"/>								
6. Names and addresses of persons who witnessed this injury. Include telephone numbers, if known.	15. Are you working now? If YES, please specify date and time of return to work. _____, 20____, at _____ A.M. <input type="checkbox"/> P.M. <input type="checkbox"/>								
7. Did the injury occur on the worksite? Please give exact location (city, town, place). YES <input type="checkbox"/> NO <input type="checkbox"/>	16. Did you attempt to work during layoff? If YES, please specify dates and amount earned. YES <input type="checkbox"/> NO <input type="checkbox"/> 17. Show normal working week by entering hours worked each day. <table style="width: 100%; border-collapse: collapse;"> <tr> <td style="width: 60%;"></td> <td style="width: 5%;">Sun.</td> <td style="width: 5%;">Mon.</td> <td style="width: 5%;">Tues.</td> <td style="width: 5%;">Wed.</td> <td style="width: 5%;">Thur.</td> <td style="width: 5%;">Fri.</td> <td style="width: 5%;">Sat.</td> </tr> </table>		Sun.	Mon.	Tues.	Wed.	Thur.	Fri.	Sat.
	Sun.	Mon.	Tues.	Wed.	Thur.	Fri.	Sat.		

PLEASE READ CAREFULLY

"I declare all the information I have given on this report is true and correct and I elect to claim compensation for the above-mentioned injuries or disease. I authorize WorkSafeBC (the Workers' Compensation Board) and Review Board to obtain or view, from any source whatsoever, including records of physicians, qualified practitioners, medical insurers or hospitals, a copy of records pertaining to examination, treatment, history and employment of the undersigned. Further, I acknowledge that WorkSafeBC may disclose information from my claim to my employer for purposes of appeal, or may disclose such information to others in accordance with the law, including the *Freedom of Information and Protection of Privacy Act*. I authorize WorkSafeBC to disclose information from my claim to the designated advocate of my union or similar association. I understand it is a serious offence to knowingly make a false claim or to work and earn income while receiving workers' compensation without advising WorkSafeBC."

Worker's signature	Date	Personal health number from your BC CareCard						
	Month Day Year							

Date: SIGNED DATE

ADDITIONAL INFORMATION CAN BE RECORDED ON PAGE 2 OF THIS REPORT. Please see the second page of this report for telephone and fax numbers.



Worker's last name	First name	Middle initial	Social insurance number	WorkSafeBC (WCB) claim number
				Worker's personal health number from BC CareCard

Additional information

Visit our web site at WorkSafeBC.com.

Mailing address for application and all claims correspondence: **WorkSafeBC**
PO Box 4700 Stn Terminal
Vancouver BC V6B 1J1

Fax number: Local 604 233-9777 or toll-free within BC 1 888 922-8807.

Telephone information

Call Centre: 604 231-8888 or toll-free within BC 1 888 967-5377.

Occupational Disease Services: 604 276-3007 or toll-free within BC 1 888 967-5377(extension 3007).

Other assistance

The Workers' Advisers Office is independent and separate from WorkSafeBC and provides free advice and assistance to help injured workers with their claims. The Workers' Advisers have offices throughout the province and can be contacted at www.labour.gov.bc.ca/wab/ or by telephone at:

- Richmond 604 713-0360 or toll-free 1 800 663-4261
- Victoria 250 952-4393 or toll-free 1 800 661-4066
- Kelowna 250 717-2096 or toll-free 1 866 881-1188

Personal information on this form is collected for the purposes of administering a worker's compensation claim by WorkSafeBC in accordance with the *Workers Compensation Act* and the *Freedom of Information and Protection of Privacy Act*. For further information about the collection of personal information, please contact WorkSafeBC's Freedom of Information Coordinator at PO Box 2310 Stn Terminal, Vancouver BC, V6B 3W5, or telephone 604 279-8171.

Date: SIGNED DATE

EMPLOYER'S REPORT OF INJURY OR OCCUPATIONAL DISEASE

Please answer all questions and complete this report in ink. The *Workers Compensation Act* requires the employer complete and submit this report within **three days** of a claimed injury, even if the employer is contesting the claim. Failure to do so is an offence and may result in the employer being charged with part of the cost of the claim. The Act requires WorkSafeBC (the Workers' Compensation Board) to collect detailed earnings information.

Please ensure that all information on this report is accurate, including the earnings data requested on the reverse side.

Registration number		Location		Classification Unit Number		Coded by		
EMPLOYER'S NAME (as registered with WorkSafeBC)				WORKER'S LAST NAME (please print) Mr. Ms. Mrs. Miss				
Mailing address				First name(s)		Middle initial		
City		Postal code		Mailing address				
Location of plant or project where injury occurred		Postal code		City		Postal code		
Type of business		Employer's telephone number		Telephone number		Social insurance number	Weight	Height
Name of contact person in your firm		Worker's occupation		Worker's personal health number from BC CareCard				Date of birth
								Month Day Year

7

1. Date and time of injury 20 , at a.m./p.m.		8. Do you know of any previous pain or disability in the area of the worker's present injury? If YES, please explain. <input type="checkbox"/> YES <input type="checkbox"/> NO <input type="checkbox"/> UNKNOWN	
OR period of exposure resulting in occupational disease FROM 20 TO 20		9. Do you know of any defect or disability the worker had prior to the injury (e.g. lost finger, blindness, deafness, etc.) If YES, please specify. <input type="checkbox"/> YES <input type="checkbox"/> NO <input type="checkbox"/> UNKNOWN	
2. Injury was first reported to employer TO <input type="checkbox"/> First Aid <input type="checkbox"/> Supervisor ON 20 , at a.m./p.m. or		10. Were there any witnesses? If YES, please give name and address. <input type="checkbox"/> YES <input type="checkbox"/> NO <input type="checkbox"/> UNKNOWN	
2A. Do you have any objections to the claim being accepted? If YES, please explain. If insufficient space, please attach a letter to this report. <input type="checkbox"/> YES <input type="checkbox"/> NO		10A. Do witnesses, if interviewed, confirm worker's statement? <input type="checkbox"/> YES <input type="checkbox"/> NO	
3. Please describe fully what happened to cause the injury and mention all contributing factors: description of machinery, weight and size of objects involved, etc. OR 3A. In cases of occupational disease, describe when and how exposure occurred, mentioning any gases, vapours, dusts, chemicals, radiation, noise, source of infection or other causes. Please explain fully.		11. Please indicate worker's employment status: <input type="checkbox"/> Seasonal <input type="checkbox"/> Casual <input type="checkbox"/> Temporary <input type="checkbox"/> Part Time <input type="checkbox"/> Permanent, Full Time <input type="checkbox"/> Other (please provide details)	
4. Please state ALL injuries reported, indicating right or left if applicable.		12. Date worker started employment with you.	
5. Did worker receive first aid? If YES, please attach a copy of report 7A, First Aid Report. <input type="checkbox"/> YES <input type="checkbox"/> NO		13. Date worker started this job.	
6. Did worker attend a physician or qualified practitioner or clinic? If YES, please give name and address if known. <input type="checkbox"/> YES <input type="checkbox"/> NO		14. Were worker's actions at time of injury for the purpose of your business? If NO, please explain. <input type="checkbox"/> YES <input type="checkbox"/> NO	
7. Did worker go to a hospital? If YES, please give name of hospital. <input type="checkbox"/> YES <input type="checkbox"/> NO		15. Were they part of the worker's regular work? If NO, please explain. <input type="checkbox"/> YES <input type="checkbox"/> NO	

Questions 16 to 29 inclusive are on the reverse side of this report.
Please see the reverse side of this report for telephone and fax numbers.



Worker's last name	First name	Middle initial	Social insurance number	Worker's claim number
Worker's personal health number from BC CareCard				

16. Does worker operate as a subcontractor? If YES, please provide details. <input type="checkbox"/> YES <input type="checkbox"/> NO	24. Will any payment be made to the worker by your firm for period of disability (other than day of injury)? If YES, please specify. <input type="checkbox"/> YES <input type="checkbox"/> NO																								
17. Is worker a relative of employer or a partner or principal of the firm? If YES, please specify. <input type="checkbox"/> YES <input type="checkbox"/> NO																									
18. Was any person not in your employ responsible for this injury? If YES, please give details and name and address of such person. <input type="checkbox"/> YES <input type="checkbox"/> NO	25. Wages paid on last day worked. \$																								
19. Is alternate light duty or modified work available? <input type="checkbox"/> YES <input type="checkbox"/> NO	26. Show normal work week by entering hours worked each day. If regular worker, fill out Week 1 only.																								
20. Will worker be off work beyond the day of injury? If YES, please complete questions 21 to 29 inclusive. <input type="checkbox"/> YES <input type="checkbox"/> NO	<table border="1"> <thead> <tr> <th></th> <th>Sun</th> <th>Mon</th> <th>Tues</th> <th>Wed</th> <th>Thur</th> <th>Fri</th> <th>Sat</th> </tr> </thead> <tbody> <tr> <td>Week 1 ▶</td> <td></td> <td></td> <td></td> <td></td> <td></td> <td></td> <td></td> </tr> <tr> <td>Week 2 ▶</td> <td></td> <td></td> <td></td> <td></td> <td></td> <td></td> <td></td> </tr> </tbody> </table>		Sun	Mon	Tues	Wed	Thur	Fri	Sat	Week 1 ▶								Week 2 ▶							
	Sun	Mon	Tues	Wed	Thur	Fri	Sat																		
Week 1 ▶																									
Week 2 ▶																									
21. Please be accurate in supplying wage information/worker's gross earnings at the time of injury (please enter one rate only). per hour \$ per day \$ per week \$ per month \$	Does the worker work a fixed shift rotation? If YES, please provide the details, including the shift rotation start date. <input type="checkbox"/> YES <input type="checkbox"/> NO																								
22. Worker's exact gross earnings for: 3 months \$ _____ prior to date of injury 1 year \$ _____																									
23. Are any of the following additions to regular wages: (please check appropriate box) <input type="checkbox"/> holiday pay <input type="checkbox"/> room and/or meals <input type="checkbox"/> rental <input type="checkbox"/> vehicle allowance <input type="checkbox"/> differential <input type="checkbox"/> equipment <input type="checkbox"/> shift premium <input type="checkbox"/> other If YES, please provide complete details.	27. Please enter hours on last day worked. FROM _____ a.m./p.m. TO _____ a.m./p.m.																								
Employer's signature	28. Date and time last worked after injury. 20 _____, at _____ a.m./p.m.																								
Title	29. Has employee returned to work? If YES, please specify date and time of return to work. <input type="checkbox"/> YES <input type="checkbox"/> NO 20 _____, at _____ a.m./p.m.																								
Date																									

Personal information on this form is collected for the purposes of administering a worker's compensation claim by WorkSafeBC in accordance with the **Workers Compensation Act** and the **Freedom of Information and Protection of Privacy Act**. For further information, please contact WorkSafeBC's Freedom of Information Coordinator at 6951 Westminster Highway, Richmond BC, V7C 1C6, or telephone 604 279-8171.

For additional information on WorkSafeBC, please refer to our web site at WorkSafeBC.com

Mailing address for report and all claims correspondence: WorkSafeBC
PO Box 8940 Stn Terminal
Vancouver BC V6B 1H9
Fax number: Local 604 233-9722 or
toll free within BC 1 888 922-8803

Telephone information

Call Centre: 604 231-8888 or toll free within BC 1 888 967-5377.

Occupational Disease Services, call 604 276-3007 or toll free within BC 1 888 967-5377 (extension 3007).

Please Note: If you have concerns with this claim, please contact the officer handling the claim at the WorkSafeBC office to make known your objections or you may submit a letter detailing your specific concerns.

Impartial Advice on WorkSafeBC Claims – To ensure you have an opportunity to obtain impartial advice on WorkSafeBC claims matters, the BC legislature has provided impartial advisers. **Employers' Advisers** are available to provide independent advice or clarification on a WorkSafeBC claim related to your firm. For additional information on the Employers' Advisers, please refer to their web site at www.labour.gov.bc.ca/eao/.

Lower Mainland 604 713-0303 (Richmond) Toll free 1 800 925-2233	Kelowna 250 717-2050 1 866 855-7575	Prince George 250 565-4285 1 888 608-8882	Victoria 250 952-4821 1 800 663-8783
---	---	---	--

Step #1**Hazard Assessment Checklist**

Company:

Location:

Date:

Assessment Team:

Position:

*Priority Status for Corrective Action:

1 = **HIGH RISK** – (Danger) 2 = **MODERATE RISK** – (Hazardous) 3 = **LOW RISK** – (Caution)

ITEM #	IDENTIFIED HAZARDS (ACTIVITIES AND CONDITIONS)	*STATUS (PRIORITY) (1-2-3)	SAFETY HAZARD AND LOCATION
1	Housekeeping		
2	Material Storage		
3	Waste Disposal		
4	Lighting		
5	Ventilation		
6	Extreme Temperatures (cold/hot)		
7	Radiation Exposure		
8	Gas (Toxic or Non-Life-Supporting)		
9	Flammables (Fire/Explosion)		
10	Dangerous Pressure		
11	Chemicals		
12	Hazardous Materials (WHMIS)		
13	High Risk Positioning		
14	Electrical Hazards		
15	Overhead Hazards		
16	Underground Hazards		
17	Confined Space Entry		
18	Excavation		
19	Restricted Access/Egress		
20	Ladders		
21	Work at Heights		
22	Scaffolds		
23	Work over Water		
24	Major Lifts (hoisting)		
25	Vehicles		
26	Mobile Equipment		
27	High Traffic		
28	Power Tools		
29	Permits		
30	Communications		

Note: For corrective action, transfer information by priority number (i.e., 1,2,3) to step #2 "Work Place Hazard Corrective Action" form.

For use with Step #1

Step #2					WORKPLACE HAZARD CORRECTIVE ACTION FORM				
Company:									
Assessment Location(s):							Time/Date:		
Department/Areas Covered:									
Assessment Team: Name					Position				
_____					_____				
_____					_____				
HAZARD INFORMATION					FOLLOW-UP				
ITEM #	PRIORITY	RECOMMENDED ACTION w/ COMPLETION DATE			ACTION TAKEN DATE/TIME	BY WHOM			
COPIES TO: (FOR ACTION)					(FOR INFORMATION)				
_____					_____				
_____					_____				
Manager's Signature:					Date:				

Post signed JHA & Hazard Assessment forms at the workplace



Safe Work Practices / Procedures / Instruction

HEALTH AND SAFETY MEETING MINUTES

“ _____ ”
(Site Name)

SUPERINTENDENT: (CHAIR) - _____ SAFETY OFFICER: (CO CHAIR) - _____

MEETING DATE: _____ NEXT MEETING DATE: _____

Attendees:

Absent:

Previous Business (Minutes Review, Safety Items):

1. _____
2. _____
3. _____
4. _____
5. _____

New Business (Tabled Items, Worker Suggestions):

1. _____
2. _____
3. _____
4. _____
5. _____

Corrective Action:

1. _____
2. _____
3. _____
4. _____
5. _____

Signature of Site Superintendent: _____ Signature of Safety Officer: _____



Safe Work Practices / Procedures / Instruction

INSPECTION CHECKLIST

Area: _____ Date: _____

Inspection Team:

Reviewed by: _____

S=satisfactory **U**=unsatisfactory (provide details for all U items) **N/A**=not applicable

1. Work Environment	S	U	N/A	Comments
floors/aisles/stairs free of tripping hazards				
handrails/guardrails in place				
floor/ground in good repair (no heaving, cracks, uneven surfaces)				
adequate lighting in place				
floor openings/trenches barricaded				
floors free of slipping hazards				
underground utilities located				
room to work around power lines				
gases/vapours/fumes controlled				
noise levels acceptable				
heat/cold extremes controlled				
aisles/halls free of clutter; exits not blocked				
exits clearly marked				
materials/equipment stored appropriately				
shelves are secure and solid				
garbage disposed properly; garbage not overflowing				



Safe Work Practices / Procedures / Instruction

2. Task	S	U	N/A	Comments
where heavy lifting is required, assists are available				
jobs have been analyzed to reduce need for manual lifting, awkward postures and repetitive movements				
written procedures are in place for critical tasks (e.g. CSE, lock-outs, etc.)				
staff have appropriate training and experience for the work they are doing				
workers are following appropriate procedures				
no unsafe actions were noted				

3. Hazardous Materials	S	U	N/A	Comments
containers are properly labeled; labels are legible				
containers are in good condition				
appropriate safety containers are used (e.g. for flammables)				
incompatible materials are stored separately				
hazardous materials are stored below eye level				
compressed gas cylinders are restrained and capped				
MSDS are available and current				



Safe Work Practices / Procedures / Instruction

4. Equipment	S	U	N/A	Comments
correct equipment and tools available				
equipment maintained as per maintenance program				
equipment guards in place				
defective/damaged hand tools not in use				
power tools maintained properly; damaged tools not used				
equipment / tools stored appropriately				
ladders/scaffolds/step stools available				
equipment blocked or secured against unplanned energy release				
personal protective equipment available, appropriate, and maintained				
maintenance person available to service/repair tools and equipment				
maintenance program followed				

5. Emergency Response	S	U	N/A	Comments
Emergency Response Plan in place and appropriate to work site				
workers know what to do in emergency				
emergency lighting in place				
emergency shower/eyewash available and working				
first aid supplies stocked; staff have first aid training				
adequate number of fire extinguishers in place; inspected monthly				
other specialized plans in place and tested (e.g. confined space rescue)				



Safe Work Practices / Procedures / Instruction

Areas Inspected: _____ Date: _____

Inspection Team:

Approved by: _____

What's Working Well

Provide information about conditions, activities, etc. that are working well:

Corrective Actions Required

Action Item Number: _____

Description of Hazard: _____

Location: _____

Priority: _____

Existing Controls: _____

Are controls working as planned? _____

Recommended Actions: _____

Employee Responsible: _____ Date Required: _____

Date Completed: _____ Initial: _____



Safe Work Practices / Procedures / Instruction

Action Item Number: _____
Description of Hazard: _____
Location: _____
Priority: _____

Existing Controls: _____

Are controls working as planned? _____

Recommended Actions: _____

Employee Responsible: _____ Date Required: _____

Date Completed: _____ Initial: _____

Action Item Number: _____
Description of Hazard: _____
Location: _____
Priority: _____

Existing Controls: _____

Are controls working as planned? _____

Recommended Actions: _____

Employee Responsible: _____ Date Required: _____

Date Completed: _____ Initial: _____



Safe Work Practices / Procedures / Instruction

SITE SAFETY INSPECTION REPORT

“ _____ ”
Site name

SAFETY OFFICER: _____ DATE: _____

INSPECTION #1
TIME: _____

INSPECTION # 2
TIME: _____

#	LOCn	HAZARD	ABC	ACTION TAKEN	TIME
1		_____ _____ _____		_____ _____ _____	
2		_____ _____ _____		_____ _____ _____	
3		_____ _____ _____		_____ _____ _____	
4		_____ _____ _____		_____ _____ _____	
5		_____ _____ _____		_____ _____ _____	
6		_____ _____ _____		_____ _____ _____	

ADDITIONAL NOTES:

SAFETY OFFICER SIGNATURE: _____

OCCUPATIONAL FIRST AID PATIENT ASSESSMENT

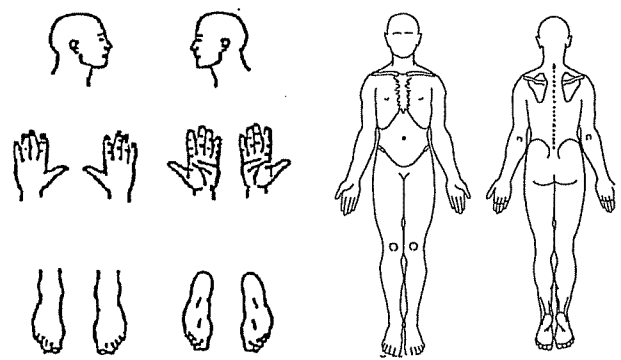
DATE AND TIME OF ILLNESS / INJURY	AM / PM	DATE AND TIME REPORTED TO FIRST AID	AM / PM								
TIME OF ARRIVAL AT FIRST AID (WALK IN)	AM / PM	TIME ON SCENE (IF APPLICABLE)	AM / PM								
EMPLOYEE NAME	DATE OF BIRTH	D	M	Y	EMPLOYER NAME	EMPLOYER PHONE NUMBER					
EMPLOYEE'S DOCTOR				CONTACT PERSON							
GLASGOW COMA SCALE		EYE OPENING RESPONSE 4 SPONTANEOUSLY 3 SPEECH 2 TO PAIN 1 NO RESPONSE		BEST VERBAL RESPONSE 5 ORIENTED 4 CONFUSED 3 INAPPROPRIATE WORDS 2 INCOMPREHENSIBLE SOUNDS 1 NO RESPONSE		BEST MOTOR RESPONSE 6 OBEYS COMMANDS 5 LOCALIZES PAIN 4 WITHDRAWS FROM PAIN 3 FLEX TO PAIN (DECORTICATE) 2 EXTENDS TO PAIN (DECEREBRATE) 1 NO RESPONSE					
PATIENTS CHIEF COMPLAINT		VITAL SIGNS		TIME		TIME		TIME		TIME	
		RESPIRATIONS									
MECHANISM OF INJURY / HISTORY OF ILLNESS		PULSE									
		LOC / GCS		E TOTAL		E TOTAL		E TOTAL		E TOTAL	
PHYSICAL FINDINGS		PUPIL SIZE & REACTION + / -		L R		L R		L R		L R	
		SKIN									
PLEASE MARK INJURED OR EXPOSED AREA 		ALLERGIES									
		MEDICATIONS									
RECOMMENDATIONS <input type="checkbox"/> RETURN TO WORK <input type="checkbox"/> FIRST AID FOLLOW UP <input type="checkbox"/> MEDICAL AID		INTERVENTIONS (PLEASE CHECK)		<input type="checkbox"/> AIRWAY CLEARED <input type="checkbox"/> MAINTAINED <input type="checkbox"/> OROPHARYNGEAL AIRWAY <input type="checkbox"/> VENTILATED <input type="checkbox"/> PKT. MASK <input type="checkbox"/> BVM <input type="checkbox"/> CONTROLLED BLEEDING <input type="checkbox"/> OXYGEN ADMINISTERED LPM _____		DEFINITIVE TREATMENTS (PLEASE CHECK)		<input type="checkbox"/> TRACTION <input type="checkbox"/> SPLINTED <input type="checkbox"/> IMMOBILIZED <input type="checkbox"/> SPINAL IMMOBILIZATION <input type="checkbox"/> ADDITIONAL TREATMENTS (PLEASE EXPLAIN)			
		TRANSPORTED BY (PLEASE CHECK) <input type="checkbox"/> ETV <input type="checkbox"/> INDUSTRIAL AMBULANCE <input type="checkbox"/> B.C. AMBULANCE SERVICE <input type="checkbox"/> AIR EVACUATION <input type="checkbox"/> OTHER (PLEASE EXPLAIN)		CHANGES IN PATIENTS CONDITION (PLEASE EXPLAIN)							
F.A.A. NAME (PLEASE PRINT)			F.A.A. SIGNATURE			OFA CERTIFICATE #		OFA LEVEL			
								<input type="checkbox"/> 1 <input type="checkbox"/> 2 <input type="checkbox"/> 3			
NAME OF WITNESSES (PLEASE PRINT)				EMPLOYER MAILING ADDRESS				STREET / AVENUE			
EMPLOYEE SIGNATURE				CITY / TOWN				POSTAL CODE			

Respiratory Protection Hazard Assessment and Selection Form

Agency/Institution: _____

Worksite: _____

General Description of Job Task: _____

Job Classification(s) _____

Level of physical exertion required to perform job: _____

Respiratory hazard(s) present: _____

PEL: _____ ACGIH TLV (if applicable: _____)

Is monitoring data available? _____ Yes _____ No

If yes, attach to this form.

Contaminant concentrations present in the workplace:

Contaminant(s): _____ Concentration: _____

Contaminant(s): _____ Concentration: _____

Contaminant(s): _____ Concentration: _____

Does data indicate levels that exceed applicable limits? _____ Yes _____ No

Do data indicate IDLH concentrations? _____ Yes _____ No

Note: Wherever hazardous exposure(s) cannot be identified or reasonably quantified, the atmosphere must be considered IDLH.

Does data indicate oxygen deficiency (less than 19.5%)? _____ Yes _____ No

Is the respirator for routine use or emergency use? _____

Additional factors (i.e. temperature and humidity levels, etc.): _____

Communication requirements: _____

Are engineering/ administrative controls feasible? _____ Yes _____ No

If no, describe reasons: _____

Type of respirator selected: _____ air purifying _____ atmosphere supplying

Style of respirator selected: _____ tight-fitting _____ loose-fitting

Make: _____

Model# _____

Type of canister or cartridge to be used: _____

Cartridge/canister change schedule if applicable _____

Name of Evaluator: _____ Date: _____

Title: _____

Work Phone: _____ Other: _____



Safe Work Practices / Procedures / Instruction

Safety Violation Report

PROJECT: _____ DATE: _____

ADDRESS: _____ SUPERINTENDENT: _____

The following individual(s), Trade or Contractor have been found in violation of the Company Health and Safety Program.

Employer: _____ Supervisor: _____

Address: _____ City: _____ Phone: _____

Employee(s) Involved:

VIOLATION: Is this a repeat offence of a previous violation? [] Yes [] No * Check all that apply

Minor Violation: 1st Offence – verbal warning [] 2nd offence – written warning [] 3rd offence – Action required []

Major Violation: 1st Offence – written warning [] 2nd offence – Action required [] (see definitions below)

Table with 5 columns: Verbal Warning (Date), Written Warning (Date), Suspension (Date), Fine(s) (Amount), Banned (Date)

Description / Location of Occurrence(s) (Please indicate Policy and/or Regulation reference section number where possible)

Four horizontal lines for describing the violation.

Major Violation: Definition: Any infraction of government, corporate or client rules or legislation that DOES have the potential to cause serious damage or injury.

Minor Violation: Definition: Any infraction of government, corporate, or client rules that does not have the potential to cause serious damage or injury.

Management: _____ (print) Management: _____ (signature)



Safe Work Practices / Procedures / Instruction

SITE SAFETY ORIENTATION

Name: _____ Date: _____
 Position: _____ Company: _____
ID Number: _____

(Please Initial)

Build safety into the plan, by thinking safety before the commencement of work

Topics Covered	Y	N	Safe Work Practices Covered	Y	N
	E	O		E	O
S			S		
Adhere to Company Safety Policy			Ladders (Secured & Inspected)		
In case of emergency, Ph # _____ Name _____ Relationship _____			Scaffolds (Inspection before each use)		
You have the right to refuse unsafe work			Rebar Protection (Install guards)		
Responsibility to correct safety hazards			Fall Protection / Working @ Elevation		
Reporting Unsafe Acts / Conditions			Lockout / Tag Out		
Reporting Accidents / Injuries			Assured Grounding		
Report any Medical Conditions to First Aid			Guardrails (Install & Replacement)		
Smoking/Drugs/Alcohol Zero Tolerance			Movement Around Concrete Pours		
Evacuation Procedure: 1 Long Blast			Excavations		
How to Contact First Aid: 3 Short Blasts			Power Tools		
Personal Protective Equipment			Mobile Equipment (Eye Contact)		
Proper Clothing Required			Transport of Equipment/Personnel on Site		
Attend all Tool Box & Site Safety Meetings			Power Lines (Limits of Approach)		
Safety Inspections			Traffic Control		
Courtesy & Consideration to Public & Patrons			High Visibility Vests		
"Zero Tolerance" regarding Fall Protection			Confined Spaces Entry		
Hole Coverings Secured and Marked			Access / Egress Routes Clear		
WHMIS Program and MSDS Locations			Housekeeping		
WHMIS Training: 4 questions to ask yourself			Lighting		
Review of Disciplinary Policy			Rigging / Cranes / Loading		
			Welding, Cutting, Burning & Fire Watch		
			Valid First Aid Ticket – Level 1 – 2 – 3?		
			Valid Hearing Test Card?		
			Danger & Caution Taped Areas		

Allergies/Medical Conditions: _____

I have read, understand and will comply with the company New Worker Orientation and I agree to comply with current Occupational Health and Safety Regulations and Site Safety Directives.

Worker Signature: _____ CSO/Supervisor Signature: _____

*If a worker cannot understand English, a co-worker may translate the information discussed in this orientation, **and** the translator must be on site anytime the non-English speaking worker is on site.*

Translator Name: _____ Translator Signature: _____



Safe Work Practices / Procedures / Instruction

TOOL BOX TALK

Project Name: _____ Date: _____

Contractor Name: _____ Time: _____

Contractor Foreman/Supervisor: _____

Items Discussed:

Action to be Taken:

Other Business:

Workers in Attendance:

1	6	11
2	7	12
3	8	13
4	9	14
5	10	15

(Use reverse side if necessary).

This form must be completed and forwarded to the site Safety Officer.



Safe Work Practices / Procedures / Instruction

W.H.M.I.S. CONTROLLED PRODUCT INVENTORY

Project: _____

Supervisor: _____

Date: _____

Class of Product	Product Name	M.S.D.S Filed	Labels Applied	Worker Training

Class of Product must be one of the following:

1. Compressed gas
2. Flammable and Combustible Material
3. Oxidizing Material
4. Serious Toxic Material (Immediate)
5. Chronic Toxic Material (Long Term)
6. Biohazard
7. Corrosive Material
8. Dangerously Reactive Material



Safe Work Practices / Procedures / Instruction

Occupational Asbestos Exposure Control Plan

Statement of Purpose and Responsibilities

If a worker is or may be exposed to potentially harmful levels of asbestos, the employer must develop and implement an exposure control plan meeting the requirements of [section 5.54](#). To ensure adequate coordination of the overall plan, the employer must ensure that it is administered by a properly trained person. Compliance with this regulation is mandatory and provides a basis for both employers and workers to work together to solve health and safety issues by successfully identifying potential hazards.

The Asbestos Exposure Control Plan (AECPP) is intended to detect, assess and control any potential health hazard caused by the presence of asbestos identified within our work. The primary focus of the plan is to eliminate accidental worker and/or contractor exposure to asbestos fibres and to ensure the health and safety of workers and visitors. To accomplish these goals, Sonic Drilling Ltd has developed an AECPP. Specific work procedures, general work practices and training to facilitate the implementation of the Plan are an integral part of this document.

Sonic Drilling Ltd is committed to ensuring the well-being of its employees and contractors and to this end has developed an Asbestos Exposure Control Plan (AECPP) for our scope of work in order to satisfy these needs with regard to asbestos issues.

Management Responsibilities:

Management responsibilities include:

- Co-ordination of work activities that relate to asbestos containing areas.
- Informing personnel and contractors of asbestos locations.
- Asbestos identification.
- Inspection and reassessment procedures.
- Program review.
- Safe Work procedures.
- Worker awareness training.
- Ensuring work is carried out using appropriate Safe Work Procedures.
- Ensuring workers at risk have appropriate training.
- Emergency work procedures.
- Waste management.

The owner or the principal contractor must ensure that the WCB receives a Notice of Project at least 24 hours before beginning work on the following types of projects:

- Removing, encapsulating or enclosing friable asbestos building materials.
- Demolishing, dismantling or repairing any part of a structure or building in which insulating materials containing asbestos have been used or in which asbestos-containing products have been manufactured.



Safe Work Practices / Procedures / Instruction

Employee Responsibilities:

Employee responsibilities include:

- Ensuring asbestos containing materials are not damaged or disturbed in areas they occupy.
- Informing supervisors and management of any damage to asbestos containing materials.
- Follow Safe Work Procedures as outlined in this Exposure Control Plan.

What is Asbestos?

Asbestos is a naturally occurring material once used widely in the construction industry. Its strength, ability to withstand high temperatures, and resistance to many chemicals made it useful in hundreds of applications.

However when asbestos is inhaled, it can be harmful and lead to the following diseases:

- asbestosis
- lung cancer
- mesothelioma (cancer of the lining of the chest and/or abdomen).

Asbestos Recognition

Asbestos is the generic name for a group of naturally occurring fibrous minerals. Asbestos colour may range from white to a pale yellow, green or blue. Asbestos fibres are very harmful to the lungs. They may cause lung scarring (asbestosis), lung lining scarring (pleural scarring), cancer of the lung lining (mesothelioma) and lung cancer.

Time lapse before the disease becomes evident may be 20-40 years. Workers who smoke have a 10-15 times greater risk of lung cancer from asbestos exposure than workers who do not smoke.

The high strength, flexibility, heat and chemical resistance, and frictional properties of asbestos led to its widespread use in electrical insulation, high strength asbestos cement products, pipe covering, floor tiling and asphalt. A good measure of the hazard posed by asbestos is its friability - the ease with which it can be crumbled or pulverized. Products with "bound" asbestos do not pose a hazard unless they are cut, sawn, ground or sanded.



Safe Work Practices / Procedures / Instruction

Health Monitoring

Health monitoring for asbestos requires supervisors, employees, and management promptly reporting any suspected exposures or symptoms which can be linked to exposure to asbestos.

These suspected exposures and symptoms shall be reported to Sonic Drilling Ltd First Aid and the Supervisor for further investigation. Chronic exposure to asbestos may increase the risk of lung cancer, mesothelioma, and nonmalignant lung and pleural disorders. Shortness of breath is the primary symptom of health effects due to exposures to asbestos.

Other symptoms include a persistent and productive cough, chest tightness, chest pain, loss of appetite, or a dry, crackling sound in the lungs while inhaling. Cigarette smoking greatly increases the likelihood of a person developing lung cancer as the result of asbestos exposure.

Potential Health Effects of Asbestos

Asbestos has been recognized as a health hazard for people employed in its production and processing for centuries. However, it was not until the late Nineteenth century, with the onset of the Industrial Revolution, that its use became widespread, and it was not until the early part of the Twentieth century that the relationship between the use of asbestos and a variety of health effects became a source of concern to the medical profession.

Since the beginning of this century many serious, debilitating and often fatal diseases have been linked to the respiration of asbestos fibers. Although the mechanism of asbestos related diseases is still not fully understood, it is known that there is normally a long waiting (latency) period between the time of exposure and the occurrence of disease. This latency period can typically be between ten to over forty years.

Asbestosis, Mesothelioma and Lung Cancer are the diseases most commonly associated with asbestos exposure, although several other diseases have been linked to asbestos exposure.

Asbestos Use

Asbestos was inexpensive to mine and has some very useful physical properties. As a result, it has been used in over 3000 different commercial products worldwide.

Some of these physical properties include:

- High temperature resistance
- Tensile strength greater than steel
- Good soundproofing properties
- High chemical resistance
- Good electrical insulating properties
- Good mechanical strength



Safe Work Practices / Procedures / Instruction

Asbestos has been widely used in building construction over many years and some uses continue today. Asbestos products are generally classed into two groups: friable and non-friable.

Friable materials are those that, when dry, can be crumbled, pulverized or reduced to powder using moderate hand pressure. The use of friable materials in construction is banned today but due to its widespread use in the past, these materials are still present in many buildings today. In order to establish a proper AECOP, the possible uses of asbestos must be known.

Risk Identification, Assessment and Control

Supervisors must ensure a risk assessment is conducted by a qualified person on asbestos-containing material identified in the inventory, with due regard for the condition of the material, its friability, accessibility and likelihood of damage, and the potential for fibre release and exposure of workers.

Supervisors also must ensure that a risk assessment has been conducted before any demolition, alteration, or repair of machinery, equipment, or structures where asbestos may be disturbed.

Before work involving asbestos takes place the supervisor must ensure that a qualified person assesses the work activity and classifies it as a **low, moderate, or high risk** activity.

Hazard Control

Supervisors must ensure that a friable asbestos-containing material in the workplace is controlled by removal, enclosure or encapsulation so as to prevent the release of airborne asbestos fibre and must not allow any work that would disturb friable asbestos-containing material unless necessary precautions have been taken to protect workers. If there is a risk to a worker from exposure to a hazardous substance by any route of exposure, the employer must eliminate the exposure, or otherwise control it below harmful levels and below the applicable exposure limit established under the WorkSafeBC regulation [section 5.48](#) by:

- substitution
- engineering control
- administrative control, or
- personal protective equipment.

When selecting a suitable substitute, the employer must ensure that the hazards of the substitute are known, and that the risk to workers is reduced by its use. The use of personal protective equipment as the primary means to control exposure is permitted only when:

- a) substitution, or engineering or administrative controls are not practicable, or
- b) additional protection is required because engineering or administrative controls are insufficient to reduce exposure below the applicable exposure limits, or
- c) the exposure results from temporary or emergency conditions only.

IMPORTANT

The qualified person referenced above must be an occupational health and safety professional with experience in the practice of occupational hygiene as it relates to asbestos management.



Safe Work Practices / Procedures / Instruction

Training

Worker training is a regulated requirement for all individuals that may have cause to come into contact with asbestos containing materials during the normal course of their work. The training for workers that may inadvertently disturb asbestos containing materials will typically be less involved than that of contracted workers, who will be required to show that they have had the relevant training.

Sonic Drilling Ltd personnel will be required to recognise any damaged materials or debris that they may encounter and report their findings immediately to their supervisor for action.

All contract employees working in areas containing asbestos containing materials will be responsible for adequately training their workers to deal correctly with the hazard.

The training program will be carried out by an asbestos specialist with expertise in the area and should include:

- An asbestos awareness program, including health effects and elements of risk.
- Training in the use of protective clothing and equipment, work procedures and air monitoring.
- An appreciation of current WCB Regulations.
- The use of respirators and their maintenance.
- An awareness of the company AECP.

Documentation

All documentation that is related to training and instruction must be maintained for a minimum of 3 years. Additionally, records of corrective actions to control asbestos fibre release, written work procedures and all written WorkSafeBC notifications must be maintained for a minimum of 3 years as well as documentation of asbestos-containing materials inventories and risk assessments, inspections and air monitoring results for a minimum of 10 years.

Sonic Drilling Ltd must maintain documentation of asbestos-containing materials inventories and risk assessments, inspections and air monitoring results for a minimum of 10 years.

Program Review

The Asbestos Exposure Control Plan (AECP) must be reviewed annually for the following:

- The capability of **Sonic Drilling Ltd** to disseminate the program to incoming contractors
- The effectiveness of the program as it applies to ensuring employees and contractors are not exposed to airborne asbestos fibres
- Document control

The annual review will be done in consultation with the Joint Occupational Health and Safety Committee.



Safe Work Practices / Procedures / Instruction

Safe Work Procedures

The employer must ensure that procedures for handling or using asbestos-containing material prevent or minimize the release of airborne asbestos fibres and must ensure that the procedures for control, handling or use of asbestos are in accordance with procedures acceptable to WorkSafeBC.

The procedures must address:

- containment of asbestos operations where applicable
- control of the release of asbestos fibre
- provision, use and maintenance of appropriate personal protective equipment and clothing
- means for the decontamination of workers, and
- removal of asbestos waste and cleanup of asbestos waste material
- The procedures must provide a worker with task-specific work direction that addresses both hazards and necessary controls.

If workers unexpectedly discover a material they believe may be asbestos where they are working (e.g.: inside a pipe chase), they must alert their supervisor immediately.

The supervisor will take immediate actions including:

- alerting workers in the vicinity to the presence of the material,
- removing the workers from the environment where exposure may occur,
- restricting access to the area and posting warning notices,
- contacting an approved asbestos removal contractor to take a sample, and provide an assessment,
- where necessary, coordinating the removal or encapsulation of the asbestos
- filing a complete report to head office.

In circumstances where it is necessary that work continue in the hazard area, workers who may be affected by the presence of asbestos will be provided with written procedures and protective clothing and equipment, which must be used.

Also see Sampling and Assessments

Note: To remove Asbestos a worker requires knowledge of the type of asbestos, knowledge of the proper choice and use of PPE and Respirators, understanding of containment procedures and knowledge of proper handling, storage and waste removal procedures. **For type 3 removals, training is a legal requirement.**

DO NOT REMOVE OR DISTURB ASBESTOS CONTAINING MATERIAL. IF YOU ARE INSTRUCTED TO DO SO, STOP WORK AND CONTACT YOUR SUPERVISOR. ONLY LOW RISK ABATEMENT ACTIVITIES WILL BE UNDERTAKEN. HIGH RISK ABATEMENT PROCEDURES WILL BE CONTRACTED OUT.



Safe Work Practices / Procedures / Instruction

Asbestos “Low Risk” Work Activity Procedures

Low-risk work activities include working near undisturbed friable asbestos-containing materials. Another example is moving asbestos-containing waste material that is contained within a cleaned, sealed bag and then double-bagged involved in such activities should have some knowledge of the hazards of asbestos and the location of the materials.

Supervisors must clearly identify all locations of asbestos containing materials, and ensure that all workers have been instructed in any work procedure restrictions needed to prevent contact with asbestos-containing materials.

Asbestos “Moderate-risk” Work Activities

Activities that carry a moderate risk of exposure to airborne asbestos fibres include:

- Using hand tools to cut, shape, drill, grind, or remove non-friable manufactured products containing asbestos, e.g., asbestos cement pipe
- Drilling (with wetting agents, or with local exhaust ventilation) through non-friable asbestos-containing materials
- Backing mounting screws out of asbestos cement products and removing the boards or tiles intact
- Buffing floor tiles with a coarse disc
- Collecting asbestos samples for laboratory analysis
- Analyzing samples of asbestos or asbestos-containing materials in a laboratory
- Removing any part of a false ceiling to gain access to a work area (for example, during inspection) when friable asbestos containing materials are, or are likely to be,
 - lying on the surface of the false ceiling
- Removing drywall materials where joint-filling materials containing asbestos have been used
- Removing vinyl-asbestos floor coverings or other non-friable materials where the procedures do not create any friable waste
- Removing an entire piece of equipment or pipe with the asbestos-containing material remaining effectively intact (“wrap and cut” procedure)
- Demolishing a block wall (of cement, for instance) that has asbestos debris in its cavity
- Note: The amount of asbestos contamination found when the cavity is open may change the risk level to high.
- Dismantling a treated enclosure at completion of an asbestos removal project
- Setting up and removing a glove-bag apparatus for the removal of pipe insulation when the insulation is in good condition
- Using a prefabricated glove bag to remove asbestos insulation from piping systems
- Note while the area outside a glove bag is considered a moderate-risk area, the work activity inside a glove bag is considered high-risk; if a glove bag is torn or punctured, the risk level outside the bag automatically increases and the site-specific emergency procedures must be implemented.



Safe Work Practices / Procedures / Instruction

Clean-up activities that carry a moderate risk of exposure to airborne asbestos fibers include:

- Using a HEPA-filter vacuum to clean ceiling tiles or light fixtures with light to moderate contamination
- Using a HEPA-filter vacuum to clean an area before setting up an enclosure
- Dismantling a treated enclosure at completion of an asbestos removal project
- Setting up and removing a glove-bag apparatus for the removal of pipe insulation when the insulation is in good condition
- Using a prefabricated glove bag to remove asbestos insulation from piping systems
- Note While the area outside a glove bag is considered a moderate-risk area, the work activity inside a glove bag is considered high-risk; if a glove bag is torn or punctured, the risk level outside the bag automatically increases and the site-specific emergency procedures must be implemented.

Asbestos “Moderate-risk” Procedures

Anyone involved in any moderate-risk work activity must follow written work procedures similar to those described here. To ensure that anyone in or near the work area is not exposed to airborne asbestos fibers, the following must be done:

1. Clearly mark the designated work area boundary by placing barricades, fences, or similar structures around the work area.
2. Place signs around the work area warning people not to enter the area unless authorized to do so.
3. Wear appropriate protective clothing:
4. Wear a respirator fitted with a “100” (HEPA) filter.
5. Do not use compressed air to clean up or remove dust or materials from work surfaces or clothing.
6. Use polyethylene (poly) drop sheets and seal windows, doorways, and other openings to prevent the spread of asbestos dust to other work areas.
7. Before starting any work that is likely to disturb friable asbestos-containing materials on the surfaces of anything in the work area, clean up the friable materials by damp-wiping or using a vacuum cleaner equipped with a HEPA-filtered exhaust.



Safe Work Practices / Procedures / Instruction

8. During the work, clean up dust and waste (wetted if possible) using a vacuum cleaner equipped with a HEPA-filtered exhaust, or by wet-sweeping or mopping.

9. Immediately upon finishing the work, complete the following tasks:

- Wet drop sheets and barriers.
- Fold them to contain any remaining dust.
- Bag or place them in a sealable container.
- Dispose of them as asbestos waste.

10. Before leaving the work area, complete the following tasks:

- Clean protective equipment and clothing by damp-wiping or using a vacuum cleaner equipped with a HEPA-filtered exhaust before taking them outside the contaminated work area.
- Leave any protective clothing worn in the work area in the designated storage area or facility for cleaning, or place disposable protective clothing in a sealable container and dispose of it as asbestos waste. Launder non-disposable clothing

11. Place asbestos waste in a sealable container and label the container to identify its contents, hazard(s), and the necessary precautions for handling the waste materials. To prevent any interference with the work activity, do not allow containers of asbestos waste to accumulate in the work area. Remove containers from the work area at the end of each work shift, if not more often, and ensure that the containers remain under effective control if they are stored at the worksite before being disposed of.

12. Before removing asbestos waste containers from the work area, clean their external surfaces by wiping with a damp cloth or using a vacuum cleaner equipped with a HEPA filtered exhaust. Double bagging is a good practice.

13. After completing the work, provide the owner or employer occupying the area with documentation stating that it is safe for unprotected workers to re-enter the work area.

Decontamination of Workers

Our company as well as sub-contractor procedures must have written decontamination procedures for the provision and use of hygiene facilities and decontamination procedures whenever we/they perform moderate or high risk work with asbestos.

Waste Handling and Disposal

All asbestos waste and other waste contaminated with asbestos, including disposable protective clothing and equipment must be placed into sealed containers and labeled as containing asbestos.

This must be performed in the designated work area. The containers must be cleaned with a damp cloth or vacuum-cleaner with a HEPA-filtered exhaust prior to removal from the designated work area. Once sealed and cleaned, the asbestos waste must be disposed of promptly at an authorized landfill.



Safe Work Practices / Procedures / Instruction

DEMOLITION (Asbestos Removal)

The preceding and following procedures must be followed when determining if any materials on the demolition site contains asbestos:

1. The employer or contractor is responsible for determining if materials containing asbestos are present at the job site before work begins.
2. If asbestos materials are found, only trained and qualified workers must remove and dispose this material before any work begins.

If during work activities, materials are found to contain asbestos, all work must be stopped immediately and must be reported to the supervisor.

Refer to the list below showing possible locations of asbestos.

Exterior Surfaces

- Deck under sheeting
- Cement asbestos board siding & under sheeting
- Roof felt & shingles
- Window putty

Interior Surfaces

- Sprayed-on acoustical ceilings
- Acoustical tiles
- Textured paint
- Heat reflectors (woodstoves)

Appliances

- Refrigerators, freezers, portable dishwashers
- Toasters, slow-cookers
- Ovens, hair dryers (not shown) & portable heaters (not shown)

Electrical Equipment

- Lamp sockets
- Outlet and switchboxes
- Insulation on knob and tube wiring
- Recessed lighting
- Main panel and fuse boxes

Insulation

- Loose blown-in full insulation
- Batt insulation

Built-in Equipment

- Water heaters
- Range Hoods
- Clothes dryers
- Dishwashers

Flooring

- Heat source-covering
- Air duct-lining
- Door and cover gaskets
- Pipe-lagging
- Wall gaskets and lining

Heaters & Piping

- Heat source-covering
- Air duct-lining
- Door and cover gaskets Pipe lagging
- Wall gaskets and lining

Miscellaneous

- Cat box aggregate (sand or clay)
- Fireplace logs
- Asbestos hot pads
- Asbestos gloves



Safe Work Practices / Procedures / Instruction

Sampling and Assessments

The first step towards safeguarding workers is to conduct an asbestos hazard assessment.

The assessment involves collecting representative samples of materials throughout the work area.

The following steps are the components of the sample collection method conducted for the work area. These procedures are also to be used to collect additional samples for specific projects or additional sampling of unidentified materials should that be necessary.

- All persons working in the immediate area of the sampling will be informed as to the nature of the work being carried out and suitable precautions will be taken to prevent them from being exposed to airborne asbestos fibres. If practicable, only the person collecting the material (sample) should be present in the area.
- A representative sample shall be taken from within the suspect material by penetrating the entire depth of the material. One sample should be taken from each different floor or area of material of different appearance. Mechanical insulation must be sampled on all straight runs, elbows and fittings on piping as well as from tanks, vessels and furnaces.
- The material should be sampled when the area is not in use. Only persons needed for sampling should be present in the immediate area.
- The material to be sampled must be sprayed with a light mist of water to prevent fibre release during sampling and the material must not be disturbed any more than absolutely necessary.
- The use of a respirator during sampling is normally required, since significant amounts of airborne fibres can be generated during sampling of deteriorating materials.
- If pieces of material break off during sampling, the contaminated area must immediately be cleaned up with a vacuum cleaner equipped with a **High Efficiency Particulate Aerosol (HEPA)** Filter or by wet cleaning. Small amounts of material must be placed in plastic ziplock bags, labelled, sealed and disposed of as asbestos waste, using the approved waste disposal procedure.

Samples shall be submitted to a qualified laboratory for analysis. Laboratories selected shall use a combination of both Polarized Light Microscopy (PLM) and Dispersion Staining following the Analytical Method 205 of the Workers' Compensation Board of British Columbia.

The laboratory selected will have a Quality Assurance Program in place consisting of:

- Intra-laboratory re-analysis of samples.
- Regular checks for contamination.
- Regular calibration of microscopes.
- Complete sample records and storage of samples and records.

In addition, all personnel performing analysis will have been trained in a documented and thorough in-house training program or an approved accredited Asbestos Analysis course.



Safe Work Practices / Procedures / Instruction

Documentation of Results

The results (whether positive or negative for asbestos containing) shall be documented in a readily accessible format and shall be available to personnel, contractors and any workers likely to come into contact with asbestos containing materials during the course of their work.

The report should include:

- A list of all materials containing asbestos.
- Comprehensive results of sample analysis.
- Description by area or location of all sample locations.
- A list of materials requiring prompt removal due to severe deterioration.
- A list of materials requiring minor removal or repair due to slight deterioration.

The hazard assessment report will be in the custody of the AECF Supervisor, who will inform all workers likely to disturb any asbestos containing material. This will permit them to use appropriate procedures to protect both themselves and other building occupants from the release of any airborne asbestos fibres. Ready access to all sample analysis results and this AECF plan must be provided to all workers who may come into contact with asbestos during the course of their employment.

Visual Re-Evaluation

All asbestos containing materials identified in the survey shall be re-inspected visually on a regular (minimum requirement is annually) basis. The re-inspection shall be performed by either the same person who carried out the initial survey or by a technical expert. Further samples will not be needed, but the re-evaluation must encompass all factors originally noted and should concentrate on any signs of deterioration, delamination or disturbance by workers, renovation or construction activity. In the event of disturbance of friable material by water leak, structural failure or other unforeseen occurrence, all asbestos in the area shall be re-evaluated promptly.

Any recommendations made as a result of these inspections will include details regarding the priority, nature and extent of any corrective actions.

Common corrective actions are:

- Encapsulation of damaged or exposed materials.
- Repair of damaged asbestos materials.
- Removal of damaged or exposed materials.

It is essential that maintenance procedures and contract documents include information regarding the presence of asbestos containing materials. Consideration must be given to the need for protection of all personnel, contractors and service workers that may be affected by this work.



Safe Work Practices / Procedures / Instruction

HAZARD AND EXPOSURE ASSESSMENT SUMMARY

Building / Area:

Total Area (m²): _____ Number of Persons: _____

Type of Construction: _____

Use: _____

Sprayed-on Material: Yes _____ No _____ Date: _____

This form should be completed even in the absence of sprayed or textured asbestos containing materials and should be kept on file for future reference.

Materials

Location of Material (Identify room or space and location and surface area in m² of material):

Location	Area
_____	_____
_____	_____
_____	_____
_____	_____
_____	_____

Asbestos Content: Yes _____ No _____

Type of Asbestos: _____ (State % where determined _____ %)



Safe Work Practices / Procedures / Instruction

Exposure Assessment

Carry out an exposure assessment in each room or space where sprayed or textured asbestos containing materials are located. Mark the appropriate rating.

Factors

Condition of Material

- A. Good condition _____
- B. Minor damage _____
- C. Poor condition _____

Water Damage

- A. No water damage _____
- B. Minor water damage _____
- C. Moderate to major water damage _____

Exposed Surfaced Area

- A. Insulation not exposed _____
- B. 10% or less exposed _____
- C. More than 10% exposed _____

Accessibility

- A. Not accessible _____
- B. Rarely accessible _____
- C. Accessible _____

Potential For Disturbance

- A. Low _____
- B. High _____

Air Plenum and Air Stream

- A. No air plenum or air stream _____
- B. Air plenum or air stream _____

Friable: Yes _____ No _____



Safe Work Practices / Procedures / Instruction

Definitions

- Good condition means no water damage, physical damage or deterioration.
- High potential means that ACM is exposed or accessible, in an air plenum or airstream, or is subject to vibration.
- Friable means a material which, when dry, can easily be crumbled or powdered by hand.

Analysis

Corrective Action: Yes _____ No _____

Risk Classification (Indicate risk to workers and provide explanation for classification)

- Low** Explain: _____
- Moderate** Explain: _____
- High** Explain: _____

Remarks / Comments

Additional sheets may be attached.

CONFINED SPACE ENTRY PROGRAM

Table of Contents

Section

1.0	Program Statement	3
	1.1 Confined Space Program	3
	1.2 Purpose	3
	1.3 Objectives	3
2.0	Regulations/References	3
	2.1 Regulations	3
3.0	Responsibilities/Resources Employed	3
	3.1 Safety Manager	3
	3.2 Area Supervisors	4
	3.3 Entry Supervisors	4
	3.4 Trained and Authorized Attendants and Entrants	4
	3.5 Training Frequency	5
	3.6 Training Content	5
4.0	Confined Space Locations	5
	4.1 Inventory	5
	4.2 Reclassification of Permit Required Confined Spaces	6
5.0	Entry Permits	6
	5.1 Permit Required Spaces	6
	5.2 Permit Requirements	6
6.0	Prevention of Unauthorized Entry	6
	6.1 Posting of Confined Spaces	6
	6.2 Other Necessary Precautions	6

7.0	Entry Procedures	7
	7.1 Entry Procedures	7
	7.2 Review of Entry Operations and Procedures	7
	7.3 Confined Space Equipment	7
	7.4 Evaluation of Permit Space Conditions	8
	7.5 Confined Space Hazard Identification and Evaluation	8
	7.6 Number of Attendants Required	9
	7.7 Multiple Employers/Contractors	9
8.0	Rescue Procedures	9
	8.1 Rescue Plan	9
	8.2 Rescue Equipment	9
	8.3 Rescue Practice	9
	8.4 Rescue Plan and Entry Permit	9
	8.5 Offsite Rescue Services	9
9.0	Entry Equipment	10
	9.1 Available Equipment	10
	Appendix A	11
	Confined Space Evaluation Form	11
	Appendix B	12
	Confined Space Assessment Form	12
	Appendix C	13
	Confined Space Entry Permit	13
	Appendix D	14
	Site Specific Entry Procedures	14
	Definitions	16

Section 1. Program Statement

1.1 Confined Space Program

Sonic Drilling Ltd

1.2 Purpose

The purpose of this program is to provide specific procedures/safe work practices for employees required to enter confined spaces. These procedures/practices will be implemented in compliance with all applicable provincial and federal regulations pertaining to confined space entry.

1.3 Objectives

The objectives of the Confined Space Program on **Sonic Drilling Ltd Projects** include:

- To comply with all provincial and federal regulations regarding confined spaces.
- To assess the feasibility of reducing the total number of confined spaces.
- To limit the number of confined space entries.
- To identify, evaluate, and eliminate potential hazards within the confined spaces prior to entry.
- To establish and implement a permit system for entry into confined spaces.
- To train employees who may work in confined spaces on proper procedures and entry techniques.

Section 2. Regulations/References

2.1 Regulations

Many publications and associated policies and guidelines, pertaining to the Confined Spaces Program as well as excerpts and summaries of the Workers Compensation Act, are available on the WorkSafeBC web site www.worksafebc.com

The Occupational Health and Safety Regulation pertaining to the Confined Spaces Program is also available on the web site: WorkSafeBC.com; Ref - Regulation "Part 9".

Section 3. Responsibilities/Resources Employed

3.1 Safety Manager

The Health & Safety Manager serves as the first contact for issues concerning the company confined space program. The Health & Safety Manager (or other qualified person assigned by him/her), is responsible for establishing a written Confined Space Program that includes evaluations of the confined spaces entered by employees of **Sonic Drilling Ltd**. This person must also be notified to review and evaluate any confined space program used by contractors, trades or sub-trades prior to any work in a confined space on any **Sonic Drilling Ltd** project(s).

He/she is responsible for establishing and maintaining a training program that will provide exposed employees with the understanding, knowledge, and skills necessary for safe and proper work in confined spaces. The Health & Safety Manager shall review the Confined Space Program, at least once per year, and shall revise the program as necessary to ensure that employees participating in entry operations are protected from confined space hazards.

The Health & Safety Manager is available to provide training on proper confined space entry techniques, recommend safety equipment, and assist in confined space evaluations.

3.2 Area Supervisors

The area supervisor will be responsible for identifying workers that may be expected to enter confined spaces, ensuring that these workers receive required training before entering the spaces, and ensuring that their subordinates follow established entry procedures.

3.3 Entry Supervisors

Entry Supervisors are the persons responsible for determining if acceptable entry conditions are present at the confined space where entry is planned, authorizing entry, supervising entry operations, and terminating entry when required. Entry supervisors shall be trained on necessary skills and responsibilities.

Entry Supervisors for this facility are listed below:

- 1)
- 2)
- 3)
- 4)

3.4 Trained and Authorized Attendants and Entrants

Trained and authorized attendants and entrants are responsible for working in and around confined spaces according to guidelines and work practices established by the safety manager.

Authorized entrants are also responsible for refusing to work in confined spaces until an entry supervisor has deemed entry to be safe and has given approval for entry, or if a hazard is identified while working in the confined space. The authorized attendants shall attend only one confined space entry at any one time, and shall not perform any other duties.

Authorized Entrants are:

- 1)
- 2)
- 3)
- 4)
- 5)

Authorized Attendants are:

- 1)
- 2)
- 3)
- 4)
- 5)

3.5 Training Frequency

Confined Space training will occur: before initial assignment to jobs that would require entry into confined spaces; when there is a change in assigned duties; when a change in permit space operations create a new hazard; whenever an employee deviates from established procedure; and when inadequacies in an employee's knowledge is identified.

The confined space training will include all Supervisors, attendants, and entrants. Confined space training will establish employee proficiency in the duties required by the confined space standard. Training documents will include the employee's name, signature of the trainer, and the dates of the training.

3.6 Training Content

The training programs established for _____ (Company) include:

1. Confined space identification
2. Identification and evaluation of permit space hazards
3. Proper gas meter operation
4. Safe entry techniques
5. Attendant and entrant responsibilities
6. Communication techniques
7. Rescue procedures
8. Ventilation techniques
9. Supervisory responsibilities
10. Permit completion/cancellation techniques
11. Location of permit spaces

A copy of the established training program can be obtained from the Health & Safety Manager.

Section 4. Confined Space Locations

4.1 Inventory

An in depth inspection of _____ (Project) was conducted and all areas that contained potential confined spaces were assessed. A confined space assessment form (Appendix B) was used to classify all confined spaces. When performing confined space evaluations, air monitoring and inspections will be conducted from outside the space. If evaluations cannot be performed from outside the space, the space will be entered through permit procedures. All confined space locations and classifications are listed below:

Location: (Classification (non-permit/permit-required))

- 1)
- 2)
- 3)
- 4)
- 5)
- 6)

4.2 Reclassification of Permit Required Confined Spaces

When a Permit Required Confined Space is to be reclassified to a “non-permit” status, the safety manager will issue a written certification that contains the date, the location of the space, and the signature of the person making the determination that all hazards have been eliminated. The certification shall be made available to each employee entering the space or to that employee's authorized representative. This documentation must be completed each time a permit-required confined space is reclassified, and remains in effect only as long as all of the hazards remain eliminated. This reclassification procedure is contained in the confined space assessment form (Appendix B), of this program.

Section 5. Entry Permits

5.1 Permit Required Spaces

Some confined spaces located at _____ (Project) that meet the definition of a Permit Procedure confined space. The information necessary to design a permit for permit required space entry is included at the end of this program (Appendix C).

5.2 Permit Requirements

The entry supervisor shall prepare an entry permit that contains at least all of the information listed in Appendix C. The permit shall be made available to all supervisors, entrants, attendants, authorized employee representatives, and rescue personnel. The permit must remain posted outside of the permit space entry portal, and remain there for the duration of the authorized entry. Any changes of personnel (supervisors, attendants, entrants), or testing and monitoring data shall be added to the permit. At the end of the authorized entry or after entry operations have been completed, the entry supervisor shall cancel the permit and maintain all cancelled permits for at least one year. A new and updated permit shall be developed, implemented, and maintained for each permit space entry.

Section 6. Prevention of Unauthorized Entry

6.1 Posting of Confined Spaces

All Permit-Required Confined Spaces that can be readily labeled are posted in a manner designed to inform employees of the existence/location of the dangerous space.

The signs read as follows:

DANGER! PERMIT-REQUIRED CONFINED SPACE, DO NOT ENTER!

If posting danger signs cannot be used to inform the exposed employees, use any other effective means to warn of the existence, location, and the danger posed by the permit spaces.

6.2 Other Necessary Precautions

If it is concluded that posting and training are inadequate to prevent unauthorized entry into permit spaces, covers, guardrails, fences, locks or other methods of restricting access shall be implemented.

Section 7. Entry Procedures

7.1 Entry Procedures

Site specific entry procedures have been developed for each confined space entered by _____ (Company). The site-specific entry procedures are located in Appendix D.

The following list identifies the minimal means, procedures, and practices necessary for safe permit space entry operations:

1. Identify and evaluate permit space hazards.
2. Control hazards and specify acceptable entry conditions.
3. Allow authorized entrants or employee authorized representative observe monitoring and testing.
4. Isolation of the permit space.
5. Purge, inert, flush, or ventilate the permit space as necessary to eliminate or control atmospheric hazards.
6. Provide barriers to confined spaces that protect entrants from hazards created by pedestrians, vehicles, or other external factors.
7. Verify that conditions within the permit space are acceptable throughout the duration of the authorized entry.
8. After authorized entry has concluded, or entry operations have been completed, the permits shall be cancelled and the permit space isolated from unauthorized entry.

7.2 Review of Entry Operations and Procedures

_____ (Company) shall review entry operations, procedures, and cancelled entry permits at least annually. Additionally, a review shall be conducted if there is reason to believe that the measures taken under _____ (Company) permit space program may not provide affected employees with the necessary protection. The review and revisions shall correct any deficiencies found to exist under the prior entry operations and procedures. Circumstances that require the review of the permit space program are listed below:

1. Unauthorized entry of a permit space;
2. A detection of a permit space hazard not covered by the permit;
3. The detection of a condition prohibited by the permit;
4. The occurrence of an injury, or a near-miss during entry operations;
5. The change in the use or configuration of a permit space; and
6. Employee complaints about the ineffectiveness of the permit space program.

7.3 Confined Space Equipment

When necessary the following equipment will be provided, and properly maintained.

_____ (Company) will ensure that employees required to work in or around confined spaces will properly use the following equipment:

1. Testing and monitoring equipment;
2. Ventilation equipment;
3. Communication equipment;
4. Personal protective equipment;
5. Lighting equipment;
6. Barriers and shields;
7. Equipment necessary for safe ingress and egress;
8. Rescue and emergency equipment; and any other equipment necessary for safe entry into and rescue from permit required spaces.

7.4 Evaluation of Permit Space Conditions

When conducting permit space entry operations _____ (Company) will ensure that the following evaluation of permit space conditions is conducted:

1. Test conditions of the permit space prior to any authorized entry. If the space can not be isolated (large size, or portion of continuous system), conduct pre-entry testing as is feasible, and maintain continuous monitoring of the areas occupied by authorized entrants.
2. Test and monitor the permit space as necessary to ensure that acceptable entry conditions are maintained during the course of entry operations.
3. When testing for atmospheric hazards the testing shall be conducted in the following order:
 - a. Oxygen;
 - b. Combustible gases and vapors; and
 - c. Toxic gases and vapors
4. Allow authorized entrant or employee's authorized representative observe pre-entry and subsequent testing or monitoring data.
5. Re-evaluate the permit space if authorized entrant or employee's authorized representative feel that the evaluation of the permit space was inadequate.
6. Immediately provide each authorized entrant or employee's authorized representative the results of any testing or monitoring.

7.5 Confined Space Hazard Identification and Evaluation

Confined Space Location:	Hazard Type(s):	Control Measures
1) _____	_____	_____
2) _____	_____	_____
3) _____	_____	_____
4) _____	_____	_____
5) _____	_____	_____
6) _____	_____	_____
7) _____	_____	_____
8) _____	_____	_____

7.6 Number of Attendants Required

Acceptable conditions do not exist, and authorized entry is not permitted, unless there is at least one attendant stationed immediately outside the permit space to be entered.

7.7 Multiple Employers/Contractors

_____ (Company) shall inform all other affected outside employers and contractors of the permit space locations and permit space hazards at _____ (Project).

All affected outside employers and contractors will be educated on the confined space program and confined space requirements of _____ (Company). Multiple permit space entries conducted by outside employers and contractors shall be reviewed and coordinated prior to authorized entry by any party.

_____ (Company) shall not enter into any binding business agreement with contractors or employers that do not meet the confined space program and training requirements.

Section 8. Rescue Procedures

8.1 Rescue Plan

A rescue plan shall be developed for each type of permit-required confined space at the site. Whenever feasible, the rescue plan will specify methods that do not involve entry by rescuers into the confined space. The attendant and/or the Entry Supervisor are responsible for preventing unauthorized persons in attempting a rescue inside the confined space.

8.2 Rescue Equipment

All necessary rescue equipment to effectively conduct the rescue shall be provided and in proper working condition prior to entry into the space.

8.3 Rescue Practice

At least annually, designated rescuers shall practice making a rescue using either a manikin or an actual entrant, from a space similar to the one being entered. If the space has not been entered for more than one year, the rescue practice will be conducted prior to entry.

8.4 Rescue Plan and Entry Permit

The entry permit shall verify that:

1. rescuers have been notified;
2. rescuers are physically located so they can effect a successful and timely rescue at any point during the entry;
3. rescuers have been trained on rescue from the particular space being entered;
4. all required rescue equipment is immediately available.

8.5 Offsite Rescue Services

Prior to a decision to use an off-site service to provide rescue, verification shall be made that the off-site rescue services complies with all requirements of this section.

Section 9. Entry Equipment

9.1 Available Equipment

The following equipment is available for confined space work/entry and is located

[ENTER STORAGE AREA FOR CONFINED SPACE EQUIPMENT].

Equipment list

- 1) _____
- 2) _____
- 3) _____
- 4) _____
- 5) _____
- 6) _____
- 7) _____
- 8) _____
- 9) _____
- 10) _____

APPENDIX A

CONFINED SPACE EVALUATION FORM

CONFINED SPACES ARE DEFINED AS:

An area, other than an underground working, that

1. is enclosed or partially enclosed,
2. is not designed or intended for continuous human occupancy,
3. has limited or restricted means for entry or exit that may complicate the provision of first aid, evacuation, rescue or other emergency response service,
4. is large enough and so configured that a worker could enter to perform assigned work.

PERMIT-REQUIRED CONFINED SPACES ARE DEFINED AS HAVING ONE OR MORE OF THE FOLLOWING:

1. Contains or has a potential to contain a hazardous atmosphere.
2. Requires lockout or isolation procedures to be followed, or in which there is a hazard of entrapment or engulfment.
3. Has an internal configuration such that an entrant could be trapped or asphyxiated by inwardly converging walls, or by a floor, which slopes downward and tapers to smaller cross-section.
4. Contains any other recognized serious safety or health hazard.

Confined Space Entry Decision Flow Chart (Attachment A)

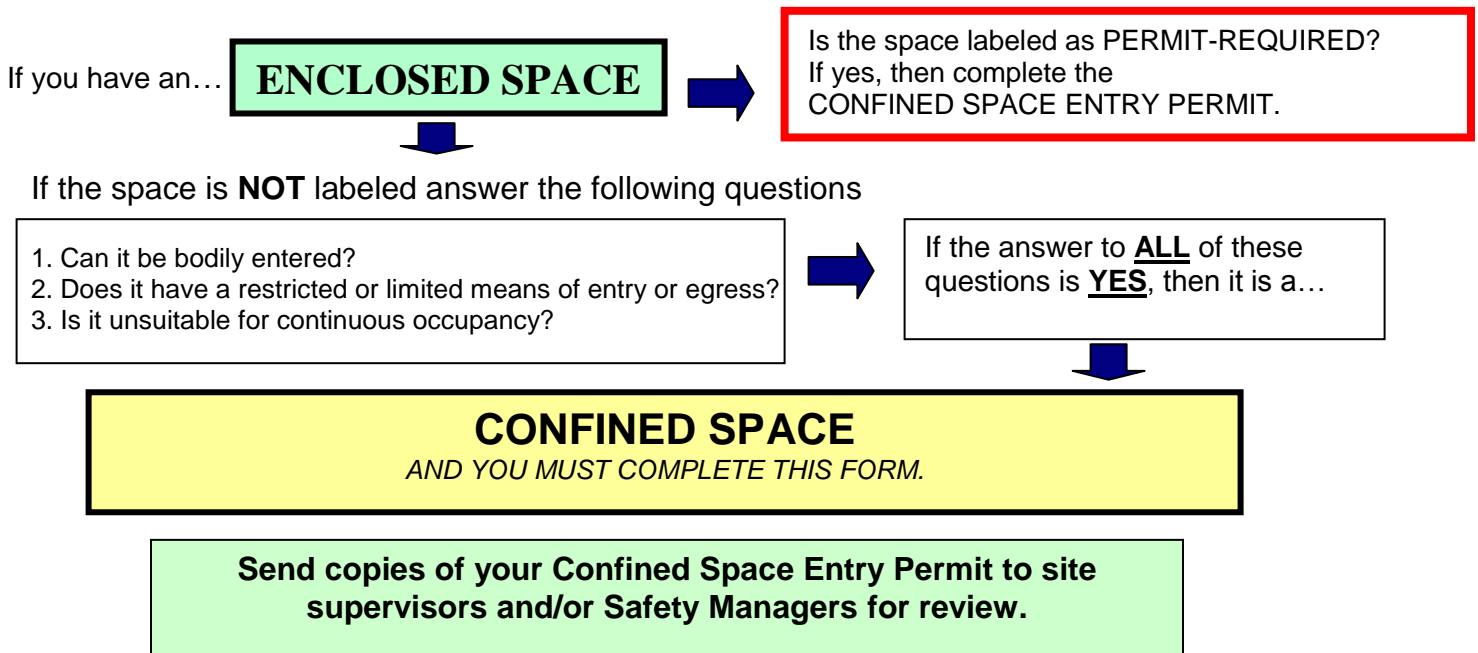

APPENDIX B

CONFINED SPACE ASSESSMENT FORM

Name of Evaluator _____

Work Area Assessed _____

Date of Assessment _____

Confined Space Determination
1. Area was not designed for continual worker occupancy YES <input type="checkbox"/> NO <input type="checkbox"/>
2. Area can be bodily entered and assigned work performed YES <input type="checkbox"/> NO <input type="checkbox"/>
3. Area has limited and/or restricted means of access and egress YES <input type="checkbox"/> NO <input type="checkbox"/>
If you answered yes to all of the above you have met the criteria of a confined space, and must proceed to the next section.
Permit-Required Confined Space Determination
1. The area contains or has the potential to contain a hazardous atmosphere YES <input type="checkbox"/> NO <input type="checkbox"/> If yes, explain and document in “Confined Space Hazard Identification and Evaluation” Pg 8
2. The area contains a material that has the potential to engulf an entrant (water, grain, sand, etc). YES <input type="checkbox"/> NO <input type="checkbox"/> If yes, explain and document in “Confined Space Hazard Identification and Evaluation” Pg 8
3. The area has an internal configuration, inwardly converging walls or a floor that slopes downward and tapers to a smaller cross section. YES <input type="checkbox"/> NO <input type="checkbox"/> If yes, explain and document in “Confined Space Hazard Identification and Evaluation” Pg 8
4. The area contains any other recognized serious safety and health hazards (electrical, thermal, mechanical, physical, chemical, etc). YES <input type="checkbox"/> NO <input type="checkbox"/> If yes, explain and document in “Confined Space Hazard Identification and Evaluation” Pg 8
If you answered yes to any one or more of the above you have met the criteria of a permit-required confined space. Permit-required spaces must be identified with the appropriate signs, and implement measures to prevent unauthorized entry (locks, bolts, etc). If employee entry is required a confined space entry program and training program must be developed and implemented.
Reclassification of Permit Required Confined Space
A space classified by the employer as a permit-required confined space may be reclassified under the following procedures:
1. If the permit space poses no actual or potential atmospheric hazards and if all the hazards within the space are eliminated without entry into the space, and the non-atmospheric hazards remain eliminated.
2. The employer shall document the basis for determining that all hazards in a permit space have been eliminated, through a certification date, the location of the space, and the signature of the person making the determination. The certification shall be made available to each employee entering the space or to that employee’s authorized representative.
3. If hazards arise within a permit space that has been declassified to a non-permit space, each person must immediately exit the space. The employer shall then reevaluate the space and determine whether it must be reclassified as a permit space.
Classification of Work Space
<input type="checkbox"/> Permit-required confined space
<input type="checkbox"/> Non permit-required confined space (does not contain hazards capable of causing serious harm or death)
<input type="checkbox"/> Enclosed space

APPENDIX C

CONFINED SPACE ENTRY PERMIT

There is not a standard format for a Confined Space Entry Permit. It can be formatted using any method as long as the permit is legible to all exposed employees, can be posted at the confined space entrance, and contains all of the following information.

All Permit-Required Confined Space (PRCS) Permits shall list the following:

1. The permit space to be entered.
2. The purpose of entry.
3. Date and authorized duration of the permit.
4. Authorized entrants (by name).
5. Authorized entrants (by name).
6. Current entry supervisor (by name). With space for name or initials of original entry supervisor who originally authorized entry.
7. Hazards of permit space to be entered.
8. Measures used to isolate permit space and eliminate or control hazards before entry.
9. Acceptable entry conditions (site specific).
10. Results of initial pre-entry testing and necessary periodic testing, accompanied by the names or initials of the testers and date/time of the testing. (Note: When testing for atmospheric hazards, test first for oxygen, next for combustible vapors and gases, and then for toxic vapors or gases.)
11. The rescue plan to be used for this space. Verify that all required elements of the rescue plan are in place.
12. The procedures used to maintain communications between authorized entrants and attendants.
13. List of equipment required to maintain compliance. (Example: PPE, testing equipment, communications equipment, alarm systems and rescue equipment).
14. Additional necessary information (site specific) that will ensure employee safety.
15. Any additional permits that have been issued to authorize work in the permit space. (Example: hot work)

APPENDIX D

SITE-SPECIFIC ENTRY PROCEDURES

PERMIT REQUIRED CONFINED SPACE ENTRY PROCEDURE

This procedure is an outline only. It does not include all required information for confined space entry.

All persons entering confined spaces or monitoring entrants in confined spaces must be trained and follow the procedures on this document and sign the entry program contained in this form.

DEFINITION: A permit required confined space is a space in which there are existing or potential atmospheric or physical hazards which could incapacitate an entrant, a space in which hazards cannot be determined prior to entry, or a space in which hot work is performed.

1. Entry teams must consist of a minimum of two people, an attendant and the entrant. Attendants and entrants must be trained on confined space entry.
2. Hazards assessment and testing must be performed by an individual familiar with the hazards of the space. This person becomes the entry supervisor and must sign the entry form.
3. The entrant(s) and attendant(s) must be briefed on emergency procedures.
4. All entrants in permit required confined spaces must wear a body harness connected to a retrieval apparatus. This requirement can only be waived by Sonic Drilling Ltd.
5. Communication equipment to contact the rescue service must be on site. The designated rescue agency “on site” should be established. The designated rescue agency “off site” should be documented.
6. An instrument capable of measuring oxygen, lower explosive gas levels, hydrogen sulfide and any other toxic substance to which the entrant might be exposed must be on site. The instrument must be calibrated frequently enough to ensure proper function.
7. If possible, atmospheric testing must be done prior to removing manhole cover. If this is not possible, move the manhole cover the minimum distance needed to insert monitoring probe.
8. Atmospheric testing shall be continuous if an atmosphere in excess of 20% of the lower explosive limit (LEL) could develop and readings recorded every two hours on the entry permit.

9. The oxygen level must be measured first and be at least 20.5% for entry to be allowed.
10. The LEL (lower explosive limit) is measured second and cannot exceed 5% for entry to be allowed.
11. The hydrogen sulfide reading is measured last and cannot exceed 5 ppm for entry to be allowed.
12. The space must be free of physical or mechanical hazards such as entrapment, engulfment or other recognized hazard which could incapacitate an entrant or appropriate safety precautions taken to prevent injury to the entrant.
13. Lockout/tagout procedures must be performed on all pipes that could discharge into the confined space and all forms of exposed hazardous energy.
14. The material safety data sheet must be on site for any chemicals used and appropriate monitoring equipment used to monitor the atmosphere.
15. Work using flame or generating sparks is defined as hot work and a permit is mandatory when performing this type of work in a confined space. See your supervisor or CSO.
16. All contractors entering confined spaces on *Sonic Drilling Ltd* property must have and follow an appropriate confined space entry program.

Definitions

- A. **ACCEPTABLE ENTRY CONDITIONS** - conditions that must exist in a permit space to allow entry and to ensure that employees involved with a permit-required confined space can safely enter and perform work.
- B. **ATTENDANT** - an individual stationed outside the permit-required confined space who had specific training and monitors the authorized entrants inside the space.
- C. **AUTHORIZED ENTRANT** - employee who is authorized to enter a permit-required space.
- D. **BLANKING OR BLINDING** - absolute closure of a pipe, line, or duct by fastening across its bore a solid plate that completely covers the bore and can withstand the maximum upstream pressure.
- E. **CONFINED SPACE** - a space that meets all the following criteria:
 - 1) is large enough and so configured that an employee can bodily enter and perform assigned work;
 - 2) has limited means of entry and egress;
 - 3) is not designed for continuous employee occupancy; and

Examples may include tanks, silos, boilers, pits, bins, manholes electrical vaults, degreasers, and hoppers.

- F. **ENGULFMENT** - surrounding and effective capture of a person by a liquid or finely divided solid substance (i.e sand, corn. grain, sawdust etc).
- G. **ENTRY** - a person's intentional passing through an opening into a permit-required confined space.
- H. **ENTRY PERMITS** - a written or printed document that allows and controls entry into a permit space.
- I. **ENTRY SUPERVISOR** - person responsible for:
 - 1) determining if acceptable conditions are present before entering a permit space;
 - 2) for authorizing entry;
 - 3) coordinating and supervising all entry operations; and
 - 4) terminating entry.

- J. HAZARDOUS ATMOSPHERE** - an atmosphere that may expose employees to the risk of death, incapacitation, impairment of ability to self-rescue, injury, or acute illness from one or more of the following causes:
1. Flammable gas, vapor or mist in excess of 10 of its Lower Flammable Limit (LFL).
 2. Airborne combustible dust at a concentration that meets or exceeds its LFL.
 3. Atmospheric oxygen concentration below 19.5 percent or above 23.3 percent
 4. Atmosphere concentration of any substance for which a dose or a permissible exposure limit is published in Subpart G, Occupational Health and Environment Control, or in Subpart Z, Toxic and Hazardous Substances, of 29 CFR 1910 and which could result in employee exposure in excess of its dose or PEL
 5. Any other atmospheric condition that is immediately dangerous to life or health.
- K. HOT WORK PERMIT** – employer’s written authorization to perform operations (for riveting, welding, cutting, burning, and heating) capable of providing a source of ignition.
- L. IMMEDIATELY DANGEROUS TO LIFE OR HEALTH (IDLH)** - any condition that poses an immediate threat to life, or a delayed threat to life, or that would cause irreversible adverse health effects, or interfere with an individual's ability to escape unaided from a permit space.
- M. ISOLATION** - process by which a permit space is removed from service and completely protects against the release of hazardous energy or material into the space.
- N. LOWER EXPLOSIVE LIMIT (LEL)** - the lowest concentration of gas or vapor, expressed in percent by volume in air, that burns or explodes if an ignition source is present at room temperature.
- O. LINE BREAKING** - intentional opening of a pipe, line, or duct that is or has been carrying flammable, corrosive, or toxic material, an inert gas or any fluid at a volume, pressure, or temperature capable of causing death or serious physical harm.
- P. NON PERMIT CONFINED SPACE**- A confined space that does not contain or have the potential to contain an atmospheric hazard or any other serious safety or health hazard.
- Q. OXYGEN DEFICIENT ATMOSPHERE** - an atmosphere containing less than 19.5% oxygen.

- R. OXYGEN ENRICHED ATMOSPHERE** - an atmosphere containing more than 23.5% oxygen.
- S. PERMISSIBLE EXPOSURE LIMIT (PEL)** - the airborne concentration of a hazardous material that must not be exceeded over a specified time or instantaneously. This value is established by the Occupational Safety and Health Administration (OSHA).
- T. PERMIT-REQUIRED CONFINED SPACE** - a confined space that has one or more of the following characteristics:
- 1) Contains or has a reasonable potential for hazardous atmospheres.
 - 2) Contains a material that has the potential for engulfment.
 - 3) Is internally configured so an employee could become trapped or asphyxiated by inwardly converging walls or a floor that slopes downward into a smaller cross-section.
 - 4) Contains any other recognized serious safety or health hazard.
- U. PROHIBITED CONDITION** - any condition in a permit space that is not allowed by the permit during the period when entry is authorized.
- V. RESCUE SERVICE** - personnel designated to rescue employees from permit spaces.
- W. RETRIEVAL SYSTEM** - equipment used for a non-entry rescue of persons from permit spaces (i.e., tripod).
- X. TESTING** - process by which hazards that may affect entrants of a permit space are identified and evaluated.
- Y. THRESHOLD LIMIT VALUE (TLV)** - the airborne concentration of a hazardous material that should not be exceeded over a specified time or instantaneously. This value is established by the American Conference of Governmental Industrial Hygienists (ACGIH).
- Z. WELDING/CUTTING PERMIT** - written authorization to perform operations that can provide a source of ignition (e.g., welding, cutting, burning, or heating) or a hazardous atmosphere.

CONFINED SPACE ENTRY PERMIT

This permit is valid for 8 hours only.

Location and description of confined space	Permit Number:
Purpose of entry	
Date of entry	Date of Expiry
Other permits required (hot work, line breaking, other)	Time of entry
Entry supervisor (print)	Time of expiry
Attendants (print)	
Known and potential hazards in space	
Describe acceptable entry conditions	
Precautions	Operational and protective equipment
<i>(Check and explain where required)</i>	<i>(Check and explain where required)</i>
<input type="checkbox"/> <input type="checkbox"/> <input type="checkbox"/> Pre-entry briefing on specific hazards and control methods	<input type="checkbox"/> <input type="checkbox"/> <input type="checkbox"/> Ladder
<input type="checkbox"/> <input type="checkbox"/> <input type="checkbox"/> Notify contractors of permit and hazard conditions	<input type="checkbox"/> <input type="checkbox"/> <input type="checkbox"/> Full body harness
<input type="checkbox"/> <input type="checkbox"/> <input type="checkbox"/> Verify adequate confined space training	<input type="checkbox"/> <input type="checkbox"/> <input type="checkbox"/> Lifeline
<input type="checkbox"/> <input type="checkbox"/> <input type="checkbox"/> Notification to effected depts/persons of service interruption	<input type="checkbox"/> <input type="checkbox"/> <input type="checkbox"/> Tripod/hoist
<input type="checkbox"/> <input type="checkbox"/> <input type="checkbox"/> Hot work permit required?	<input type="checkbox"/> <input type="checkbox"/> <input type="checkbox"/> Area security (warning signs, barricades)
<input type="checkbox"/> <input type="checkbox"/> <input type="checkbox"/> Lines blocked or broken	<input type="checkbox"/> <input type="checkbox"/> <input type="checkbox"/> Ventilation fan or blower
<input type="checkbox"/> <input type="checkbox"/> <input type="checkbox"/> Ventilation Air flush (preliminary or continuous) (Mechanical or Natural Air)	<input type="checkbox"/> <input type="checkbox"/> <input type="checkbox"/> Fire extinguisher
<input type="checkbox"/> <input type="checkbox"/> <input type="checkbox"/> Communication method (radio, rope signals, visual hand signals, verbal)	<input type="checkbox"/> <input type="checkbox"/> <input type="checkbox"/> SCBA
<input type="checkbox"/> <input type="checkbox"/> <input type="checkbox"/> Lighting (hazardous location rated or standard)	<input type="checkbox"/> <input type="checkbox"/> <input type="checkbox"/> Coveralls
<input type="checkbox"/> <input type="checkbox"/> <input type="checkbox"/> Drain space	<input type="checkbox"/> <input type="checkbox"/> <input type="checkbox"/> Face/eye protection
<input type="checkbox"/> <input type="checkbox"/> <input type="checkbox"/> Traffic barriers/ entrance covers / signage	<input type="checkbox"/> <input type="checkbox"/> <input type="checkbox"/> Footwear
<input type="checkbox"/> <input type="checkbox"/> <input type="checkbox"/> Other (specify)	<input type="checkbox"/> <input type="checkbox"/> <input type="checkbox"/> Gloves (impervious, chemical, leather, other)
<p>Rescue Procedures and Equipment</p> <p><input type="checkbox"/> <input type="checkbox"/> <input type="checkbox"/> Non-entry rescue procedure and equipment in place (Attendant will extract entrant without entering space) OR</p> <p><input type="checkbox"/> <input type="checkbox"/> <input type="checkbox"/> Entry rescue service and equipment ready to effect a timely rescue (considering hazards in space)</p> <p><input type="checkbox"/> <input type="checkbox"/> <input type="checkbox"/> List rescue equipment:</p>	<input type="checkbox"/> <input type="checkbox"/> <input type="checkbox"/> Air purifying respirator (specify cartridge type)
	<input type="checkbox"/> <input type="checkbox"/> <input type="checkbox"/> Head protection
	<input type="checkbox"/> <input type="checkbox"/> <input type="checkbox"/> Fall protection equipment
	<input type="checkbox"/> <input type="checkbox"/> <input type="checkbox"/> Communication
	<input type="checkbox"/> <input type="checkbox"/> <input type="checkbox"/> Radiation dosimeter(s)
	<input type="checkbox"/> <input type="checkbox"/> <input type="checkbox"/> Hearing protection
	<input type="checkbox"/> <input type="checkbox"/> <input type="checkbox"/> Respirator
	<input type="checkbox"/> <input type="checkbox"/> <input type="checkbox"/> Other (specify)
Notes:	Notes:

Contractor Safety Information Form: Job Hazard Analysis and Hazard Assessment Form

Department: _____

Program: Contractor Health & Safety Policy Responsibility

Owner: Program Manager

Authority: *Sonic Drilling Ltd* Safety Program, Contractor Health & Safety Policy Responsibility ¹

Contractor: (Primary)			DATE: New Revised
Owner	Foreman/Supervisor	Safety Representative	First Aid Representative
Phone:	Phone:	Phone:	Phone:

Scope (Description) of Work

*List **all** trades, sub-trades and companies retained and working directly under this primary contractor

Sub-Contractors	Supervisor	Safety Representative (name and title)

* **Please Note:** The "Primary" contractor is responsible to ensure all aspects of safety compliance by each sub-contractors / trades retained by them to work on any project(s).

¹ *Sonic Drilling Ltd. Occupational Health & Safety Program.*

Post signed JHA & Hazard Assessment forms at the workplace

Contractor Safety Information Form: Job Hazard Analysis and Hazard Assessment Form

Employer: _____

DATE: _____

Material Safety Data Sheets (MSDS)

Hazardous materials used on this site are/will be	Location(s) of MSDS
1.	
2.	
3.	
4.	
5.	
6.	

List of Emergency Response Plans(s) Collected (i.e. Fall Protection, Confined Space etc.)

Emergency Plan	Designated person (In Charge)

Post signed JHA & Hazard Assessment forms at the workplace

Step #1**Hazard Assessment Checklist**

Company:

Location:

Date:

Assessment Team:

Position:

*Priority Status for Corrective Action:

1 = **HIGH RISK** – (Danger) 2 = **MODERATE RISK** – (Hazardous) 3 = **LOW RISK** – (Caution)

ITEM #	IDENTIFIED HAZARDS (ACTIVITIES AND CONDITIONS)	*STATUS (PRIORITY) (1-2-3)	SAFETY HAZARD AND LOCATION
1	Housekeeping		
2	Material Storage		
3	Waste Disposal		
4	Lighting		
5	Ventilation		
6	Extreme Temperatures (cold/hot)		
7	Radiation Exposure		
8	Gas (Toxic or Non-Life-Supporting)		
9	Flammables (Fire/Explosion)		
10	Dangerous Pressure		
11	Chemicals		
12	Hazardous Materials (WHMIS)		
13	High Risk Positioning		
14	Electrical Hazards		
15	Overhead Hazards		
16	Underground Hazards		
17	Confined Space Entry		
18	Excavation		
19	Restricted Access/Egress		
20	Ladders		
21	Work at Heights		
22	Scaffolds		
23	Work over Water		
24	Major Lifts (hoisting)		
25	Vehicles		
26	Mobile Equipment		
27	High Traffic		
28	Power Tools		
29	Permits		
30	Communications		

Note: For corrective action, transfer information by priority number (i.e., 1,2,3) to step #2 "Work Place Hazard Corrective Action" form.

Post signed JHA & Hazard Assessment forms at the workplace

For use with Step #1

Step #2					WORKPLACE HAZARD CORRECTIVE ACTION FORM				
Company:									
Assessment Location(s):							Time/Date:		
Department/Areas Covered:									
Assessment Team: Name					Position				
_____					_____				
_____					_____				
HAZARD INFORMATION					FOLLOW-UP				
ITEM #	PRIORITY	RECOMMENDED ACTION w/ COMPLETION DATE			ACTION TAKEN DATE/TIME	BY WHOM			
COPIES TO: (FOR ACTION)					(FOR INFORMATION)				
_____					_____				
_____					_____				
Manager's Signature:					Date:				

Post signed JHA & Hazard Assessment forms at workplace



SONIC DRILLING LTD.

ADVANCED DRILLING TECHNOLOGY

SITE SPECIFIC HEALTH AND SAFETY MANUAL

Introduction

Welcome to Sonic Drilling Ltd. You are now part of a progressive, service oriented company. As part of the SDL team, you will be working for a company that is unique in the Canadian drilling industry.

About our Company....

SDL was incorporated in 1979 by Ray Roussy. He had worked for Hawker Siddley as part of a design team working on developing a high-frequency vibratory drill rig. Unfortunately, the machine that they developed had frequent and catastrophic failures. When Hawker Siddley abandoned the project, Ray took the knowledge he had gathered, did his own research, and developed a sonic drill that was reliable. Ray holds patents on his improvements to the technology.

The first Sonic Drilling Ltd. drill rig was put into service in 1987. The rig worked on a variety of projects until 1991 when SDL entered the environmental drilling market. From 1991 onward, the sonic drill rig was booked almost 100% of the time. During this time, Ray had built drill heads for other drilling contractors in the US. It **wasn't until 1998 when Ray redesigned the sonic** drill head that SDL finally got its second sonic drill rig. Sonic Drilling Ltd. remains as the only drilling contractor in Canada with sonic drill rigs.

Note: Since it is impossible for this manual to cover every possible hazard one might encounter on the job, please use common sense when working.

EMPLOYEE CONFIDENTIALITY AGREEMENT	page 5
this agreement must be submitted to the office administration department at the time of hiring	
EMPLOYMENT STANDARDS ACT	page 6
SAFETY POLICY STATEMENT	
HEALTH AND SAFETY CONTENTS	page 7
OBJECTIVES	page 8
GENERAL STATEMENT OF COMPANY POLICY	
EMPLOYEE AWARENESS AND PARTICIPATION	
GENERAL MANAGEMENT	
OPERATIONS MANAGEMENT	
DRILLER / SUPERVISOR	page 9
DRILLER ASSISTANT	
MECHANIC	
RULES	page 10
APPEARANCE	
ASSIGNMENT OF RESPONSIBILITIES	
INSPECTIONS – RECORD KEEPING	
TRAINING	page 11
EMPLOYEE SAFETY TICKETS	
REQUIRED TRAINING	page 12
TRANSPORTATION OF DANGEROUS GOODS –TDG	page 12
COMMUNICATION	
COMMUNICATION EQUIPMENT	page 13
ABSTRACT REQUIRED FORM	
MSDS -Material Safety Data Sheet	page 14
WCB -Workers Compensation Board	page 15
SAFETY PROMOTION	
PUBLIC SAFETY AND SECURITY	page 16

Note: Since it is impossible for this manual to cover every possible hazard one might encounter on the job, please use common sense when working.

GENERAL PROCEDURES	
HEALTH AND SAFETY GUIDELINES	
SAFETY EQUIPMENT ON VEHICLES	page 17
DRILLING SAFETY	
DRILLING SAFETY GUIDLINE	page 18
FIRE PREVENTION	page 19
MEDICAL PROGRAM	page 20
PPE – PERSONAL PROTECTIVE EQUIPMENT	
WORKING IN THE SHOP	page 21
CARE OF YOUR PPE	
AIR RESPIRATORS	page 22
CLOTHING GUIDELINES	
MAINTENANCE ON DRILL RIG	page 23
MAINTENANCE	
HAND TOOLS	page 24
GENERAL PROCEDURES	
SITE	page 25
CLEARING THE WORK AREA	
START UP	page 26
PROCEDURES & PRECAUTIONS	
RAISING DRILL TOWER	
OPERATIONS CHARTS	page 27
SETTING UP THE DRILL RIG	
LOWERING THE DRILL TOWER	
CONNECT DRILL PIPE (ROD OR CASING)	page 28
BREAKING A DRILL PIPE JOINT	
COUNTERSINK FOR A WELL PROTECTOR	page 29

Note: Since it is impossible for this manual to cover every possible hazard one might encounter on the job, please use common sense when working.

MATERIAL HANDLING	
INCIDENT ANALYSIS	page 30
INCIDENT REPORTING	
INCIDENT INVESTIGATION	
INCIDENT FOLLOW UP	
OVERHEAD AND BURIED UTILITIES	page 31
ELECTRICITY	page 32
REACT TO CONTACT WITH ELECTRICITY	
PROPER LIFTING TECHNIQUES	page 33
PROPER LIFTING PROCEDURES	
FIRE AND CHEMICAL SAFETY	
AUDIT	page 34
MANAGEMENT OF CHANGE	
CONFIDENTIALITY	
PROHIBITIONS	
DRUG AND ALCOHOL POLICY	page 35
DRUG AND ALCOHOL POLICY AND TESTING	
DISCIPLINARY POLICY	
CELL PHONE BAN	
SUPPORT TRUCK INVENTORY	page 36
HEAVY TRUCK INVENTORY	page 37
DRILL RIG INVENTORY	page 38
DAILY WORK RECORD REQUIRMENT	page 39
VEHICLE OPERATION	page 40
SERVICE AND SUPPORT VEHICLES	
EMPLOYEE ASSISTANCE AND PREVENTION PROGRAMS	page 41
SONIC EMPLOYEE ACKNOWLEDGEMENT OF HEALTH AND SAFETY RULES	page 42
<i>**this acknowledgement must be submitted to the office administration department at the time of hiring**</i>	

EMPLOYEE CONFIDENTIALITY AGREEMENT

Upon commencement of employment with Sonic Drilling Ltd., all new employees will read and review the information and materials in this Health & Safety Plan. Supervisors and employees who need information concerning health and safety policies should also consult and review this manual as a reference tool.

All employees of Sonic Drilling Ltd must read and sign the following Employee Confidentiality Agreement.

Provision of employment contract restricting employee from divulging employer's trade secrets.

Employee agrees that any and all knowledge or information that may be obtained in the course of the employment with respect to the conduct and details of the business and with respect to the secret processes, formulas, machinery, etc. used by the employer in manufacturing its products will be forever held inviolate and be concealed from any competitor and all other persons and that he or she will not engage as employer, employee, principal, agent, or otherwise, directly or indirectly, at any time in a similar business, and that he or she will not impart the knowledge acquired to anybody and that should he or she at any time leave the employ of the employer he or she agrees not to enter into the employ or service or otherwise act in aid of the business of any rival company or concern or individual engaged in the same or in similar lines of business. If he or she does so in violation the employer shall be entitled to an injunction by any competent court of equity enjoining and restraining him [her] and each and every other person concerned from continuance of employment, services or other acts in aid of the business of the rival company or concern. Nothing shall prevent him [her], upon the termination of the employment, in engaging in any occupation in which the processes, formulas, and other secrets of the employer will not be directly or indirectly involved.

Employee's Name (print) : _____

YOUR NEW EMPLOYEE NUMBER IS # _____

Signed: _____

Witness: _____ Name (print) : _____

Dated: _____

****this agreement must be submitted to the office administration department at the time of hiring****

Note: Since it is impossible for this manual to cover every possible hazard one might encounter on the job, please use common sense when working.

EMPLOYEE STANDARDS ACT

Sonic Drilling Ltd is in compliance with the Employment Standards Act.

This Act applies to all employees, other than those excluded by regulation, regardless of the number of hours worked. The purposes of this Act are to ensure that employees in British Columbia receive at least basic standards of compensation and conditions of employment; To promote the fair treatment of employees and employers; to encourage open communication between employers and employees; To provide fair and efficient procedures for resolving disputes over the application and interpretation of this Act; To foster the development of a productive and efficient labour force that can contribute fully to the prosperity of British Columbia; To contribute in assisting employees to meet work and family responsibilities.

SAFETY POLICY STATEMENT

Sonic Drilling Ltd. is fully committed to meet all social, regulatory, and legal obligations to our employees, our clients and the general public.

The management of Sonic Drilling Ltd. is committed to maintaining a safety and loss control program comprised of:

- ◆ Company rules and policies
- ◆ Safe work procedures
- ◆ Employee training

It is essential that all employees participate in the implementation and maintenance of the safety program. The management of Sonic Drilling Ltd. will not tolerate violations of the safety program and will respond appropriately in the event of non-compliance.

We will make every effort to get the support of our clients in honouring these commitments.

Ray Roussy , PRESIDENT

Bill Fitzgerald, GENERAL MANAGER

EMPLOYEE HEALTH AND SAFETY MANUAL

As we strive to stay current with health and safety legislation, regulation, guidelines and policies for the protection of our workers, the information contained in this manual should be used in conjunction with the information provided in the 2011 **OCCUPATIONAL HEALTH AND SAFETY PROGRAM**.

The following describes the typical contents of this “**EMPLOYEE HEALTH AND SAFETY MANUAL**”:

Further information

Responsibility

Hazard Assessment

Medical Surveillance

Heat Stress

Personal Protective Equipment

Monitoring Procedures for Site Operations

Training

Safety Considerations for Site Operations

Decontaminations Procedures

Disposal Procedures

Equipment Operations

Material Handling

Emergency Response and Accident Notification

Record Keeping

OBJECTIVES

The purpose of the Health & Safety Plan is to establish the policies, responsibilities and procedures for the prevention of injury and illness and ensure the health and safety of workers/employees involved in all company activities.

GENERAL STATEMENT OF COMPANY POLICY

- Conduct all operations so the health and safety of all personnel is given the highest priority. No operation shall be pursued at the expense of the safety of individuals performing a task.
- Employees are provided with necessary training and safety instruction, including a copy of the Health and Safety Plan. Only those employees qualified by certified training experience are permitted to operate equipment.
- Employees shall adhere to the requirements of the Health and Safety Plan and other site-specific health and safety plans. Failure to comply will be grounds for disciplinary action or termination of employment.
- Employees are required to actively participate in the Health and Safety, Injury and Illness Prevention Plan. This includes attending safety meetings and adhering to all policies, rules and standards. **Active participation in this program will be a substantial part of the employee's Recognition and Goal Setting reviews.**
- All equipment will be maintained in safe working condition to prevent accident or injury due to equipment failure or malfunction.

EMPLOYEE AWARENESS AND PARTICIPATION

- Employee health and safety is essential to the success of the Company.
- Mandatory attendance is expected at regular safety meetings of all employees including management. Attendance and discussion content of meetings will be documented with follow-up actions. These meetings will be open to discuss any health and safety issue, review any incident or near miss during the quarter, and for the employees to bring any unsafe condition to the attention of management.
- The basic policy of "safety first" is stressed at each daily tailgate and quarterly safety meetings.
- The drillers/supervisors will be responsible for ensuring that all employees on their work site
- Accident and near miss reports will be generated to review and discuss at safety meetings.

GENERAL MANAGEMENT

The role of the General Manager is to provide the materials, equipment, opportunities, and trained personnel in order to complete projects safely and efficiently. This is accomplished through:

- Knowledge of and compliance with applicable regulations
- Knowledge of all materials used and their safe handling
- Familiarity with all pieces of equipment used and their safe operation
- Insuring that employees are properly trained
- Insuring that employees have appropriate safety supplies and equipment
- Performing periodic site safety inspections
- Holding monthly company safety meetings
- Performing annual company safety audits

OPERATIONS MANAGEMENT

This level of leadership has total control over specific projects. He/she is primarily an administrator when not participating in the field activities. They report directly to upper management. The driller/supervisor may fill this position on some projects.

The operations management is responsible for but not limited to the following:

- Implementing and enforcing Health and Safety, Injury and Illness Prevention Plan
- Preparing and organizing all project work
- Selecting crew personnel and briefing them on specific assignments
- Defining the scope of work
- Coordinating with the driller/supervisor, health and safety officer and all other parties involved to complete the work plan
- Ensuring that health and safety training and equipment requirements have been met
- Obtaining permission from the proper authority to enter and start work
- Coordinating with the owner and/or engineer

Note: Since it is impossible for this manual to cover every possible hazard one might encounter on the job, please use common sense when working.

DRILLER/SUPERVISOR

The driller/supervisor is responsible for field operations and the safety of workers under his/her control. Operations management may fill this position on some projects.

The driller/supervisor is responsible for, but not limited to, the following:

- Supervising field operations
- Enforcing site control
- Coordinating work activities
- Enforcing health and safety standards and procedures
- Working directly with the Site Health and Safety Officer
- Daily inspection of drill rig and completion of necessary inspection forms
- Daily pre-job hazard review and completion of necessary forms

DRILLER ASSISTANT

The Driller's Assistant works on-site with the Driller and is responsible to the Driller. The Driller's Assistant's responsibilities include:

- Knowledge of and compliance with company safety policies.
- Knowledge of and compliance with directly applicable regulations.
- Insure that they have training in the operation of the equipment
- Daily inspection of the support vehicle and completion of the necessary inspection forms.
- Job site safety
- Making recommendations to improve safety and efficiency.

MECHANIC

The Mechanic is responsible to the Manager. The Mechanic typically works in the shop but may be required to perform on-site repairs. Both in the shop and on-site, **the Mechanic's responsibilities include:**

- Knowledge of and compliance with company safety policies.
- Knowledge of and compliance with directly applicable regulations.
- Insure that they have training in the operation of the equipment.
- Observe preventative maintenance schedules.
- Make scheduled inspections and correct deficiencies.
- Correct deficiencies noted by equipment operators.
- Make recommendations to improve safety and efficiency.

Note: Since it is impossible for this manual to cover every possible hazard one might encounter on the job, please use common sense when working.

RULES

All employees of Sonic Drilling Ltd. are representatives on the company. Their actions and appearance influence how the company is perceived, both by clients and by the public. Each employee has the right and the responsibility to report unsafe working conditions. In addition, all employees have the right to refuse work because of unsafe working conditions.

APPEARANCE

Sonic Drilling Ltd. requires an employee to wear special clothing; it is without charge to the employee. Uniforms will be maintained and clean uniforms worn by employees at the expense of Sonic Drilling Ltd. Clothing are the property of Canadian Linen Uniform and must be returned when employee leaves the company.

- All employees must present themselves in a tidy manner, not just for appearance but for safety as well
- Ripped clothing or coveralls is not permitted because it is a safety hazard around rotating machinery
- Coveralls should be changed and washed periodically to minimize cross contamination between work sites
- Rainwear and rubber boots should be steam cleaned frequently to minimize cross contamination between work sites
- Long facial stubble is not permitted because it interferes with the seal of respirators
- Excessively long hair must be tied back so that it is not a hazard around machinery

Organization is necessary to safely work in the hazardous waste industry. While each site will have specific differences, the basic organizational structure will be used throughout the company. There must always be lines of authority, responsibility, and communications. A liaison with the community must also be established. All employees must be aware of these lines of authority, and perform their function in the organizational structure safely and efficiently.

ASSIGNMENT OF RESPONSIBILITY / INSPECTATIONS

All employees play a role in the implementation and enforcement of this Health and Safety Plan. The Operations Manager has overall authority for enforcement on health and safety issues and the responsibility to direct key personnel to ensure that annual health and safety inspections are conducted and all health and safety matters are addressed as soon as possible. These inspections are geared to identify existing and/or potential health and safety hazards. Any discrepancies found are resolved as soon as possible.

During inspections employees are encouraged to inform their supervisors of any health and safety discrepancies or any conditions they feel are unsafe.

INSPECTIONS—RECORD KEEPING

After each inspection a report is documented stating which discrepancies were noted and/or corrective actions measures to be taken. If a situation cannot be resolved within one week, a statement will follow the inspection report stating why the delay and the estimated time it will take to resolve the situation. A copy of the report will be kept on file in the Inspections folder for a minimum of three years.

Please see section **10.0 "INSPECTIONS"** in the **OCCUPATIONAL HEALTH AND SAFETY PROGRAM** for further details and information on Workplace Inspections.

TRAINING

The proper training of employees is the key to the implementation of an effective safety program. Areas of training include: first aid, health and safety, materials handling, vehicle operation, drivers licensing, equipment operation, hazard identification, and communication.

Employee Safety Tickets

Employee's training tickets are the responsibility of the employee. Employees must keep record of when they are due for renewal. Sonic Drilling Ltd requires a copy of all employee safety tickets and drivers licence.

SDL will pay for all fees and tuition for necessary training, except for driver's license. Employees get paid for their time in training, excluding travel time. Field personnel (Driller, Driller's Assistant) get paid for training at their reduced "Shop" rate.

Employees must have the following training:

- Safe operation of each piece of equipment that they are required to operate in the course of their job, including: trucks, drill rigs, cranes, mixers, pumps, tools, etc.
- Level 1 First Aid
- Workplace Hazardous Materials Information System (WHMIS)
- Basic Transportation of Dangerous Goods (TDG)
- **Employees working on contaminated sites should have the 40 hour OSHA 'Health and Safety at Hazardous Waste Sites' course. It is required for work on contaminated sites in the USA.**

Employees must insure that they possess the proper class of driver's license for the vehicle that they will be operating.

It must be recognized that new employees represent the highest risk on the job because of their lack of experience and/or training. It is the responsibility of the Manager to insure that each employee has the necessary training to perform each task that is required in their job description. The Manager must keep a record of all training that each employee receives.

Most training in the operation of equipment occurs 'on the job'. Employee training should be conducted by a supervisor. Ideally, a new employee should work alongside a more senior employee that holds the same job title, under the observation of a supervisor.

All new employees must be approved as competent for their position by the Manager. The following is the training structure:

- A Driller trains a Driller with close observation by the Manager.
- **A Driller trains a Driller's Assistant**
- **A Driller's Assistant trains a Driller's Assistant with close supervision by a Driller.**

Training for the position of Driller's Assistant typically lasts 2 to 5 days. Training for the position of Driller typically lasts 3 to 12 months.

A training log is kept for each new employee, tracking the dates and progress of the employee in training.

REQUIRED TRAINING

DRILLER -

Level 1 first aid, TE, OSHA, TDG, WHMIS, Class 3 (or 1) driver's license with air brake endorsement, current hearing test

DRILLER'S ASSISTANT -

Level 1 first aid, TE, TDG, WHMIS, Class 3 (or 1) driver's license with air brake endorsement, current hearing test

MECHANIC -

Level 1 first aid, TDG, WHMIS, Class 3 (or 1) driver's license with air brake endorsement, current hearing test

TDG – TRANSPORTATION OF DANGEROUS GOODS

Compliance is a three step process:

- become familiar with the basic layout and requirements of the TDG act and its regulations.
- use those regulations to determine whether any of the products you bring in or ship out are **considered "dangerous goods" according** to the detailed regulatory definitions, criteria or schedules
- decide a shipment falls under its regulatory purview; you must comply with the relevant packaging, labelling and paperwork provisions.

THE TEN COMMANDMENTS – FOR TRANSPORTING DANGEROUS GOODS

- You must know what you are doing before you handle, package, load or transport and dangerous goods
- You must train your employees to conduct their appointed tasks safely and compliance with regulations
- You must know which of your goods are dangerous, and the class, division and packaging group of each
- You must ensure your goods are packaged properly
- Your labels, placards and markings must be clear, visible and prepared in accordance with the law.
- You must have your paperwork in order and kept near to hand
- You must not spill
- Even the most careful shipper or carrier must be prepared for the worst (preparing an emergency response assistance plan
- You must confess all your mistakes promptly and in writing
- You must place the protection of human health and the environment above all else

COMMUNICATION

Communication within the company can take the form of memoranda, incident reports, employee reviews, or verbal. Lines of communication should follow the basic 'chain of command' within the company. **The Driller's Assistant is responsible to the Driller. The Driller is responsible to the Manager. The Manager is responsible to the President.**

Communication Equipment

Cellular Telephones-

Each drilling crew is supplied with a cellular telephone. Use of the phone is limited to essential calls: suppliers, repair companies, clients, etc. Communication with other crews or with the office should be made using the two-way radios.

The phone is for BUSINESS USE ONLY.

No personal calls are permitted. Employees are encouraged to use pay phones or other 'land lines' for personal calls, or purchase their own cellular phone for their personal use. Employees will not be reimbursed for business related calls made on their personal cellular telephones without prior authorization from the General Manager.

Two-Way Radios-Each drilling crew is supplied with two two-way radios. The radios are to be used for communication with other crew members, with other crews, and with the office.

The use of cellular phones or two-way radios is not permitted while operating mobile equipment or while using tools.

Safety Training- **If you don't have all of the training or certification required for your position**, SDL will insure that that you get it. If you do not already have training in First Aid, OSHA, TDG, or WHMIS, for example, training session(s) will be scheduled for you. You will be paid at "shop" rates (if applicable) for your time during your course(s).

Additional Training-You are encouraged to take courses outside of work to enhance your job skills. With the approval of the General Manager, SDL will pay the tuition or fees for courses directly relevant to your job. **However, you won't be paid** wages or salary for the time that you spend in additional training courses.

Abstract Required Form

ICBC - **National Safety Code requires all employee's to submit a copy of there Driver's Licence annually.** Our office will fill out the required forms, please promptly submit to administration when you are asked.

MSDS

A Material Safety Data Sheet is a technical bulletin that provides specific hazard information, safe handling information, and emergency procedures for a controlled product. Since the MSDS contains detailed health and safety information specific to each controlled product, it should be used as a key source of information for safe work procedures. Each drill rig must have current Material Safety Data Sheets (MSDS) for every hazardous substance that will be encountered during a project. This applies to materials handled in the course of work and contaminants that may be encountered (WCB OHS Reg. 5.16).

It is the responsibility of the Manager to supply the employees with MSDS for hazardous materials that will **be encountered while working. It is the employees' responsibility to familiarize themselves** with the available MSDS sheets. When a new MSDS sheet is issued, it is the responsibility of the Driller to update MSDS binder.

All of Sonic Drilling's trucks are equip with a MSDS Binder, and must remain in the truck at all times. These Material Safety Data Sheets are supplied to all Sonic Drilling trucks and are kept up to date by the office administration department.

Group	Responsibly
Suppliers	Provide up to date MSDS's (not more than 3years old) for all controlled products they sell or produce
	Provide supplier labels on all containers of controlled products they sell or produce
Employers	Ensure that workers understand information on MSDS. Supplier labels and workplace labels by providing effective worker education.
	Provide training in specific safe work procedures to workers who work with or near controlled products
	Ensure that all containers of controlled products in their workplace have MSDS and WHMIS labels (suppliers labels, workplace labels or other acceptable means of identification as appropriate)
	Ensure that MSDS are readily accessible to workers
Workers	Know and understand the information on labels and MSDS
	Use the information they receive through education and training to handle controlled products safely.
	Inform employers if labels are illegible or missing
WCB Prevention staff in B.C.	Administer WHMIS legislation about WHMIS to employers and workers
	Provide general information about WHMIS to employers and workers
	Ensure compliance with federal and provincial WHMIS legislation

WCB – WORKERS COMPENSATION BOARD

The Workers' Compensation Board of B.C. is dedicated to promoting workplace health and safety for the workers and employers of this province. We consult with and educate employers and workers and monitor compliance with the Occupational Health and Safety Regulation. In the event of work-related injuries or diseases, the WCB works with the affected parties to provide return-to-work rehabilitation, compensation, health care benefits, and a range of other services.

Under the requirements of the Workers Compensation Act, a worker must report an injury or a disabling occupation disease as soon as possible to the employer. Reports must be filed from the SDL office within 3 days of incident. Your claim may not be considered if this is not done. A worker may not make an agreement with the employer to give up WCB benefits.

If a worker suffers a work related injury or illness, the WCB provides fair compensation that may include medical costs, loss of earnings, physical rehabilitation and pensions. The WCB also works with employers to help injured workers return to work. If a worker is killed on the job, counselling and financial help are made available to the **victim's** family. The WCB information line can answer your questions about workplace health & safety, worker and employer responsibilities and reporting a workplace accident or incident. Phone 604-276-3100 Lower Mainland or toll-free 1-888-621-7233 (621-SAFE) To report after-hours and weekend accidents and emergencies call 604-273-7711 or toll-free 1-866-922-4357 (WCB-HELP).

We're here to protect the workers and employers of British Columbia. WCB's mandate is to:

- ◆ Prevent workplace injuries, diseases, and fatalities
- ◆ Rehabilitate injured workers and returning them to productive, safe employment
- ◆ Provide fair compensation for workers suffering from an occupational disease or injury
- ◆ Provide sound financial management for a viable workers' compensation system
- ◆ Protect the public interest

SAFETY PROMOTION

Safety is a primary concern at SDL. You will be expected to work in a safe and responsible manner at all times. Remember, the General Contract that you signed when you joined SDL states that following the Safety Program is condition of employment. Safe work practices benefit everyone.

Safety is the responsibility of all personnel at Sonic Drilling Ltd. Whether it's the creation of safety policies by management or a driller practicing safe work procedures on site, each person has a role to play. Safety awareness must be emphasized to employees. This will encourage them to adopt a "Safety Attitude". This will also convey to employees that management expects the job to done safely.

In order to maintain an effective safety program, safety must be continually promoted and emphasized within the organization. This promotion includes:

- Monthly safety meetings. The meetings will be held to discuss general safety issues and to review safety policies.
- Incident reports, both from Sonic Drilling Ltd. and from other companies.
- Regular safety inspections of job sites by the General Manager, not less than once per month per crew.

In addition, the daily job site safety meetings will reinforce to clients that Sonic Drilling Ltd. is serious about safety.

PUBLIC SAFETY AND SECURITY

Contractors are responsible for the perimeter of the work area to be appropriately fenced to safeguard the public. In addition, warning signs posted on the site fence and gate.

GENERAL HEALTH & SAFETY PLAN FOR ENVIRONMENTAL DRILLING OPERATIONS

This health and safety plan applies to all personnel working on or near the drilling operation:

Conduct site safety meeting with on-site consultant before setting up
Familiarize drill crew with contaminants which may be encountered and level of protection required
Deploy fire extinguisher at rear of rig in an easily visible location
First Aid kit is located in the cab of the drill rig on the rear wall between the driver and passenger seat

HEALTH & SAFETY GUIDELINES

General Procedures - The following personal hygiene and work practice guidelines are intended to prevent injuries and adverse health effects. This guideline is the minimum standard procedures for reducing potential risks associated with work projects.

Eating, Drinking, smoking, taking medication, chewing gum or tobacco is prohibited in the immediate vicinity of the work.
Hands and face will be thoroughly washed prior to eating, smoking or putting anything in the mouth.
Personal visitors are not allowed on site
Whenever possible, the employee shall stand upwind of the work (borehole, test pit, ect.)
Always be alert to potential changes in exposure conditions such as strong odours, unusual appearance in cuttings, oily sheen on water, ect.
Establish pre-arranged hand signals or other means of emergency communication when wearing respiratory equipment, when working around noisy equipment or when working at some distance from fellow workers.
Always be alert as to unusual behaviour, dizziness or other symptoms exhibited by yourself or by other workers at the site as this may indicate exposure to harmful substances.
Noise may pose a health and safety hazard, particularly during drilling, test pitting and construction activities. A good rule of thumb is that if you have to shout in order to communicate at a distance of three feet in continuous noise; you should be wearing hearing protection. Likewise, any impact noise from activities such as driving casing on drilling operation which is loud enough to cause discomfort would indicate the use of hearing protection. Hearing protection is available and should be included in your standard field kit, along with hard hats, safety glasses, steel toed boots, ect.
Always use the appropriate level of personal protection, lesser levels of protection can result in preventable exposure: excessive levels of safety equipment can impair efficiency and increase potential for accidents to occur.

SAFETY EQUIPMENT on VEHICLES

All Sonic Drilling Ltd. vehicles must be equipped with a first aid kit and a fire extinguisher. All personnel on site, including the client, should be aware of the location of all safety equipment. The following lists the class of vehicle and the minimum safety equipment requirements:

DRILL RIGS :	Level 1 FIRST AID KIT	20 lb ABC fire extinguisher	EYE WASH BOTTLE
HEAVY TRUCKS :	BASIC FIRST AID KIT	10 lb ABC fire extinguisher	
OTHER VEHICLES :	PERSONAL FIRST AID KIT	2.5 lb ABC fire extinguisher	

DRILLING SAFETY.... IT'S EVERYONE'S RESPONSIBILITY

Well drilling is inherently a dangerous occupation. Many recent improvements on drilling rigs have contributed to making drilling safer: including emergency cut-off switches located at the back of the rig, chain and gears that have been replaced by sealed hydraulic motors, hydraulic drill stem breakouts and hydraulic driven wire lines eliminating the need for rope and catheads, just to name a few. Most accidents still can be attributed to human error. Human error can be further subdivided into: inexperience, carelessness, being tired or substance abuse accidents from these causes can be greatly reduced by taking the obvious preventative measures.

The following is a list of DO's and DON'Ts which may help avoid unnecessary accidents:

- ✓ Do – Everyone, not just the driller, should know how to turn off the rig.
- ✓ Do –Wear gloves, your skin is too delicate to leave unprotected.
- ✓ Do – Keep equipment and tools in good working order and condition.
- ✓ Do – Regular scheduled safety meetings
- ✓ Do – **Wear your hard hat, it doesn't take much metal falling to do serious harm**
- ✓ Do – Wear your safety belt while driving.

- ✗ **Don't drill too close to overhead power lines or underground power sources.**
- ✗ **Don't re-fuel** the engine while it is running. Leaking gasoline and a spark can cause a serious explosion.
- ✗ **Don't wear loose clothing around a drill rig. Clothing caught in turning machinery** will pull the rest of your body into the machine.
- ✗ **Don't drill out of control.** There is a direct correlation between accidents and drilling too fast.
- ✗ **Don't do things that require excessive strength i.e.)** breaking pipe joints, moving heavy tools, ect., this is a precursor to getting hurt suddenly or causing long term health problems. Let the tools and the rig do the work.
- ✗ **Don't drill while lightning is seen or thunder is heard. Drill masts are excellent** lightning rods.
- ✗ **Don't use a cathead with a wet rope,** it is too unpredictable.

DRILLING SAFETY GUIDE

We care about your safety not only when you are working on or around a drill rig, but also when you are travelling to and from site, moving the drill rig and tools from location to location on a site, or providing maintenance on a drill rig or drilling tools. This safety guide is for your benefit. Failure to heed the safety procedures contained in this manual could result in serious injury or death.

Every drill crew should have a designated safety supervisor who has the authority to enforce safety on the drilling site/ a **rig worker's first** responsibilities are to obey the directions of the safety supervisor.

The safety supervisor- Is the drill rig operator. The safety supervisor must:

- Consider the responsibility for the safety and the authority to enforce safety to be a matter of first importance.
- Be the leader in using proper personal protective safety equipment and take appropriate corrective action when proper personal protective safety equipment is not being used.
- Understanding that proper maintenance of tools and equipment and general housekeeping on the drill rig will provide an environment that will promote and enforce safety.
- Before drilling is started with a particular drill, ensure that anyone operates the drill has had adequate training and is thoroughly familiar with the drill rig, its controls, and its capabilities.
- Inspect the drill rig at least daily for structural damage, loose bolts and nuts, proper tension in chain drives, loose or missing guards or protective covers, fluid leaks, damaged hoses, and/or damaged pressure gauges and pressure relief valves.
- Check and test all safety devices, such as emergency shut down switches, at least daily and preferably at the start of a drilling shift. Drilling must not be permitted until all emergency shut down and warning systems are working correctly. Do not allow any emergency device to be passed or removed.
- Check that all gauges, warning lights and control levers are functioning properly and listen for unusual sounds each time an engine is started.
- Ensure that every drill rig worker is informed of safe operating practices on and around the drill rig. Provide every drill rig worker with a copy **of the organization's drilling operations safety manual**, operations manual and maintenance manual.
- Carefully instruct a new worker in drilling safety and observe the new workers progress towards understanding safe operating practices.
- Assess the mental, emotional and physical capability of each worker to perform the assigned work in a proper and safe manner. Remove any worker from the drill site whose mental and physical capabilities might cause injury to the worker or co-workers.
- Insure that a first aid kit and fire extinguisher which are properly maintained are on each drill rig and each additional vehicle.
- Be well trained in and capable of using first aid kits, fire extinguishers and all other safety devices and equipment, Train crew members.
- Maintain a list of addresses and telephone numbers of emergency assistance units and inform other members of the existence and location of the list.

FIRE PREVENTION ... The danger of fire cannot be under estimated!

Fire can be the most devastating of accidents that can occur. Employees must be very conscious of fire prevention measures at all times.

The following points must be observed:

- **All vehicles must be equipped with a fire extinguisher rated ULC 'ABC'.**
- No smoking or open flame where flammable liquids, solvents, or fuels are stored, transported, handled, or used.
- No smoking while operating any equipment.
- No smoking on work sites except in designated areas.
- Equipment powered by internal combustion engines (except diesel powered) must be shut off
- Great care must be taken when welding or cutting so that sparks or slag do not come in contact with any flammable surface or substance. This includes wearing proper Personal Protective Equipment to insure that clothing does not burn.
- Gas cylinders must be secured, with the protective cap in place, when being transported.
- Gas cylinder valves must be turned off when not in use.

IN THE EVENT OF FIRE OR EXPLOSION:

If the situation is readily controllable with available resources, take immediate action to do so. If not:

- a.) Clear the area of all personnel working in the immediate vicinity.
- b.) Cease operation of all equipment. No cigarettes, cutting torches or other flame or spark sources shall be permitted in the area.
- c.) Immediately notify the designated Site Health and Safety Officer / Coordinator.
- d.) Keep all personnel and the general public away from the hazard.

FIRE EXTINGUISHERS

Vehicles are equipped with one 20lb fire extinguisher. Fire extinguishers are inspected in an annual basis and tagged accordingly; tags are weather resistant. All employees are to be familiar with the proper use of fire extinguishers.

OTHER SAFETY CONSIDERATIONS:

- All electrical equipment should be explosion-proof and properly grounded.
- When dealing with heavier-than-air materials, vertical exhausts and spark arrestors should be employed.
- Welding and cutting should be done away from the hole whenever possible. If it must be done at the hole, it should be initiated only after flammable levels have been monitored and spaces inserted or purged.
- Extra care must be exercised when working topographic lows, at the toes of landfills, and when employing windscreens and barriers.
- Do not keep gasoline cans around the hole.
- Remove excessive oil and grease on rig components.
- Have the right kind of fire **extinguisher for the job and make sure it's** in working condition.

PHYSICAL HAZARDS ... BE AWARE !!

TRAFFIC

When drilling on the street there is significant potential for "stuck-by" accident, make certain that you are wearing a high visibility vest or uniform.

NOISE

Large equipment and engines such as the drill rig generate significant noise during operation which could affect workers in close proximity to the operating equipment.

HEAT and SUN

Projects done during the summer months can have an affect on workers. Remain well hydrated and wear protective sun blocking agents.

HEARING CONSERVATION

Because hearing damage is irreversible, it is crucial that measures be taken to preserve the hearing of all personnel. The steps required to implement a hearing conservation program are minor compared to the **impact of the damage or loss of one's hearing.**

MEDICAL PROGRAM

OSHA recommends a medical evaluation for employees required to wear a respirator. A medical program is developed for each site based on the specific needs, location and potential exposures of employees at the site. A site medical program should provide the following components :

SURVEILLANCE

- Pre-Employment screening
- Periodic medical examinations (and follow-up examinations when appropriate)
- Termination examinations

TREATMENT

- Emergency
- Non-Emergency (on a case by case basis)

RECORD KEEPING

- Program review

PERSONAL PROTECTIVE EQUIPMENT (PPE)

The last line of defence in hazard control is Personal Protective Equipment (PPE). PPE is used when engineering or procedural controls cannot completely eliminate a hazard. The purpose of PPE clothing and equipment is to shield or isolate individuals from the chemical, physical and biological hazards that may be encountered at a hazardous waste site.

MINIMUM REQUIREMENTS WHEN WORKING ON OR AROUND DRILLING EQUIPMENT

Personal protective equipment provides a final barrier between the worker and a potential hazard, which could threaten personal health and safety. All PPE must be in accordance with CSA standards or an approved equivalent and be visually inspected prior to use.

All Sonic Drilling Ltd. Employees working on or around drilling equipment must wear the following PPE:

Individual Protective Equipment – For most geotechnical, mineral and /or groundwater drilling projects, individual protective equipment must include a safety hat, safety shoes, safety glasses and close fitting gloves and clothing. Rings and jewellery must not be worn during a work shift.

- Hardhat that meets ANSI Standard Z89.1-1986 (WCB OHS Reg. 8.11)
Safety Head Gear. Safety hats must be worn by everyone working or visiting at or near the drilling site. All safety hats must be kept clean and in good repair with the headband and crown straps properly adjusted for the individual drill rig worker or visitor.
- Safety boots that meet CSA Standard CAN/CSA-Z195-M92 (WCB OHS Reg. 8.22)
Safety boots must be worn by all drilling personnel and all visitors to the drill site that observe drilling operations within close proximity of the drill rig. All safety shoes or boots must meet the CSA standard requirements.
- Gloves. Leather provides protection against most physical characteristics like sharp objects, radiant heat and hot objects. The usual application is for general work. Leather gloves are acceptable unless working on a project in which there is a chance of chemical or contaminant exposure. All drilling personnel must wear gloves for protection against cuts and abrasions that could occur while handling wire rope or cable and from contact sharp edges and burns on drill rods and other drilling or sampling tools. All gloves must be close fitting and not have large cuffs or loose ties that can catch on rotating translating components of the drill rig.

Note: Since it is impossible for this manual to cover every possible hazard one might encounter on the job, please use common sense when working.

- Safety Glasses. CSA Standard CAN/CSA-Z94.3-92 WCB OHS Reg. 8.14). All drilling personnel must wear safety glasses when working within 5m of drill table. Safety glasses must have side shields. Contact lenses are generally discouraged at work sites and shall not be worn during any work which would expose the wearer to chemical, gases, vapours, dust or other materials that may harm the eyes or cause irritation. Contact lenses should not be worn when wearing self contained breathing apparatus.
- Hearing protection that meets CSA Standard Z94.2-94 (WCB OHS Reg. 7.14). When working within 5m of drill table
- Coveralls. (WCB OHS Reg. 8.19). Coveralls must fit properly and be free from holes and tears. Employees must wear fire resistant coveralls when working at oil refineries, or if required by site regulations (WCB OHS Reg. 8.31) The clothing of the individual drill rig worker is not generally considered protective equipment; however, the workers clothing should be comfortable but must be close fitting, without loose ends, straps, draw strings, belts or otherwise unfastened parts that might catch on some rotating or translating component of the drill rig.
- Reflective vest (WCB OHS Reg. 8.24).
- Respirator. Please use the protective plastic containers that are provided to keep your respirator clean and dry. Each employee has their own respirator, clearly marked with their name. You must be fit tested for your respirator.

WORKING IN THE SHOP

Employees working in the shop must wear the following PPE:

- Safety boots that meet CSA Standard Z195.
- Safety glasses (when grinding, drilling, or cutting) that meet CSA Standard Z94.3.
- Hearing protection (when hammering steel or operating loud equipment) that meet CSA Standard Z94.2.
- **Gloves...**
- Coveralls. Coveralls must fit properly and be free from holes and tears.
- Leather gloves should be worn when welding or cutting.

Fall Protection

Fall protection is required when employees are working more than 3m (10ft) from the ground. Employees are not permitted to climb the drill tower without adequate fall protection (WCB OHS Reg. 11.2).

Personal Flotation Devices (PFD).

Employees performing work on a dock, pier, wharf, or barge must wear a PFD that meets Canadian Government Specifications Board Standard 65-GP-11, or equivalent.

Other

Appropriate face shields and eye protection must be used when welding, cutting, or grinding.

CARE OF PPE

Employees are expected to insure that their PPE is safe, clean, and functional. The following is a guide to the care of PPE:

- Hardhat suspension must be replaced every year (check date stamp).
- Hardhats must be replaced every 5 years (check date stamp).
- Respirators should be disinfected periodically and they must be kept in a labelled, sealed container.
- Rubber boots must be free of holes.
- Rubber boots should be steam cleaned regularly.
- Rainwear should be free of holes and tears.
- Rainwear should be steam cleaned or pressure washed regularly.

AIR PURIFYING RESPIRATORS

All employees that work on potentially contaminated sites must be fit-tested for a half-face air-purifying respirator (APR). Each employee must keep his or her respirator in a labelled, sealed container.

Considerations and limitations on the use of air purifying respirators:

- Facial hair must not interfere with the respirator seal against the face. Beards and long stubble are not permitted. Moustaches and closely trimmed goatees are acceptable provided they do not interfere with the respirator seal.
- APR may not be used in environments that are immediately dangerous to life or health.
- APR may not be in oxygen-deficient atmospheres (<18%).
- When working with potential eye irritants, a full-face APR must be used.

The following is a brief guide to respirator cartridge selection:

- HEPA (purple): provide protection against dusts (including silica), mists, welding fumes, asbestos, lead, radon daughters, and radio-nuclides.
- Organic Vapour (black): provide protection against most organic vapours including organic solvents and petroleum products.
- Organic Vapour/Acid Gas (yellow): provide protection against most organic vapours and acid gases such as chlorine, hydrogen chloride, and sulphur dioxide.
- Ammonia (green): provide protection against ammonia and most amines.
- **Manufacturer's specifications should be consulted when selecting respirator cartridges.**

CLOTHING GUIDELINES

Dressing for appropriate weather conditions is very important. The following are some guidelines for dressing for extreme cold. It is not just a matter of comfort, but in an emergency situation, it could be a matter of life or death.

Cold weather clothing should consist of a three-layer system.

- The first layer is the base layer. This layer should be long underwear made of polypropylene or thin **fleece. This layer transports moisture away from the skin. Polypropylene maintains most of its** insulating properties even when it is wet. Some people use silk for the base layer, but silk has poor durability and is hard to care for.
- The second layer is the insulating layer. This layer traps air to keep you warm. It also transports **moisture away from your body. This layer is typically fleece. Fleece maintains most of its** insulating properties even when wet.
- The third layer is the protection layer. This layer protects you from wind and snow. In outdoor recreation, this layer is often a waterproof breathable material like Gortex. For our purposes, this layer will be the insulated coveralls.

The three-layer system should apply to your hands as well. Wearing a thinner liner glove will provide additional insulation. Also, it will allow you to take off the outer work glove for short periods of time if you need dexterity to do delicate work or handle small parts.

- No cotton! Cotton is extremely poor insulation. It traps moisture and it takes a very long time to dry. Having a wet layer against your skin will conduct heat away from your body very rapidly. Cotton and cotton blends should be avoided for all items of clothing. It is well known among climbers and mountaineers that **COTTON = DEATH**
- Wool is OK, but manufactured materials like fleece are superior for moisture transport and warmth when wet.

MAINTENANCE ON AND AROUND THE DRILL RIG

The first requirement for safe field operations is that the safety supervisor understand and fulfil the responsibility for maintenance on and around the drill rig. The safety supervisor must:

- a.) Provide suitable storage locations for all tools, materials and supplies so that these items can be conveniently and safely handled without hitting or falling on a member of the drill crew or a visitor.
- b.) Avoid storing or transporting tools, materials or supplies within or on the mast of the drill rig.
- c.) Stack pipe, drill rods, casing, augers and similar drilling tools in orderly fashion on racks or sills to prevent spreading, rolling or sliding.
- d.) Place penetration or other driving hammers in a safe location on the ground or secure them to prevent movement when not in use.
- e.) Keep work areas, platforms, walkways, scaffolding and other access ways free of materials, debris, obstructions and substances such as ice, grease or oil that could cause a surface to become slick or otherwise hazardous. Keep all controls, linkages, warning and operation lights and lenses free of oil, grease and /or ice.
- f.) Store gasoline only in a non-sparking, red container with a flame arrester in the fill spout and having **the word "gasoline" easily visible**.

MAINTENANCE

Faulty and poorly maintained vehicles, equipment and tools can become a hazard on a work site. Good Maintenance will make drilling operations safer. Also, maintenance must be performed safely. The following point are essential to safety:

- a.) Wear safety glasses when performing maintenance on a drill rig or on drilling tools.
- b.) Shut down the drill rig engine to make repairs or adjustments to a drill rig or to lubricate fittings (except repairs or adjustments that can be made with the engine running). Take precautions to prevent accidental starting of an engine during maintenance by removing or tagging the ignition key.
- c.) Block the wheels or lower the levelling jacks or both and set hand brakes before working under a drill rig.
- d.) Release all pressure on the hydraulic systems, the drilling fluid system and the air pressure systems of the drill rig – when possible and appropriate – prior to the performing maintenance. In other **words, reduce the drill rig and operating systems to "zero energy state" before performing** maintenance. Use extreme caution when opening drain plugs and radiator caps and other pressurized plugs and caps.
- e.) **Do not touch an engine or the exhaust system of an engine following it's operation** until the engine and exhaust system have had adequate time to cool.
- f.) Never climb the mast (derrick) to do maintenance or make repairs. Lower mast, stop engine and deenergize rig before starting maintenance or repair on the mast.
- g.) Never weld or cut on or near a fuel tank.
- h.) Do not use gasoline or other volatile or flammable liquids as a cleaning agent on or around a drill rig.
- i.) Follow the manufactures recommendations for applying the proper quantity and quality of lubricants, hydraulic oils and/or coolants.
- j.) Replace all caps, filter plugs, protective guards or panels, and high pressure hose clamps and chains or cables that have been removed for maintenance before returning the drill rig to service.

HAND TOOLS

Since there are almost an infinite number of hand tools that can be used on or around a drill rig and in repair shops, there are an equal number of instructions for proper use. **"Use the tools for its intended purpose" is the most important rule. The following suggestions apply to safe use of several hand tools that frequently are used on and around drill rigs:**

- a.) When a tool becomes damaged, either repair it before using it again or get rid of it.
- b.) When using a hammer, any kind of hammer for any purpose, wear safety glasses.
- c.) When using any kind of chisel or punch, for any purpose, wear safety glasses.
- d.) Keep all tools cleaned and stored appropriately when not in use.
- e.) Use wrenches, not pliers, on nuts. Use screwdrivers with blades that fit the screw.
- f.) When using a wrench on a tight nut, first use some penetrating oil and then use the largest wrench available that fits the nut. When possible pull on the wrench handle rather than push on it; apply force to the wrench with both hands when possible and with both feet firmly placed. Always assume that you may lose your footing; check the place that you may fall for sharp objects.
- g.) Keep all pipe wrenches clean and in good repair. Use a wire brush frequently to clean the jaws of pipe wrenches. An accumulation of dirt can cause wrenches to slip.
- h.) Never use pipe wrenches in place of a rod-holding devices.
- i.) Replace hook and heel jaws when they become visibly worn
- j.) When breaking tool joints on the ground or on a drilling platform, position your hands so that your fingers will not be smashed between the wrench handle and the ground or the platform if the wrench should slip or the joint suddenly let go.

GENERAL PROCEDURES

General Health and Safety Plan for Environmental Drilling Operations

The following personal hygiene and work practice guidelines are intended to prevent injuries and adverse health effects. These guidelines present the minimum standard procedures for reducing potential risks associated with this and other projects and are to be followed by all Sonic Drilling employees.

- Consult site meeting with on-site consultant before setting up.
 - Every working day, a brief safety meeting shall be held before work commences.
 - Review scope of work and schedule. Review higher risk tasks and the related precautions.
- Familiarize drill crew with contaminants which may be encountered and level of protection required.
 - Safety expectations
 - Safety policies and general requirements
 - Site specific Safety Method Statements
 - Protective clothing and equipment
- Deploy fire extinguisher at rear of rig in an easily visible location.
- First aid kit is located in cab of drill truck on the rear wall between the driver and passenger seat.

SITE

All personnel entering a site must observe minimum Personal Protective Equipment requirements.

All personnel working near a drill rig should be made aware of the exclusion zone.

A clean and organized site not only looks more professional but also is a safer situation. Site organization should include:

- Placing drill pipe on blocks or timbers.
- Returning tools to their proper place. Leaving a tool lying around is not only a tripping hazard but may result in losing or forgetting the tool.
- Picking up garbage as it is created. Bags from well materials should be gathered during the construction of a well rather than at the end.

CLEARING THE WORK AREA

Prior to drilling, adequately clear and level the site to accommodate the drill rig and supplies and provide a safe working area. Do not begin drilling if tree limbs, unstable ground, or site obstructions cause unsafe tool handling conditions.

OPERATION RULES

During the operation of company owned, leased, or personal vehicles on Company business, the operator shall:

- Require all occupants to wear seat belts
- Follow safe Cell Phone use guidelines
- Obey all local, state, federal and client traffic laws/rules
- Not operate vehicles in "hazardous" areas or past "do not enter" barricades
- Use extreme caution around congested areas where personnel and or equipment are working
- Not leave engines running if vehicle is unattended
- Lock vehicle unless prohibited by client (while on client's property)
- Assure that transporting samples or other items in vehicle will only be done in a safe manner and in accordance with 49CFR
- Not use personal vehicles to transport regulated materials and hazardous waste. 40 CFR and 49 CFR shall be consulted for the requirements

START –UP

Instruct all drill rig personnel **and visitors to “stand-clear” of the drill rig immediately prior to starting the engine.**

- a.) Make sure brakes are set, all gear boxes are in neutral, all hoist levers are disengaged, all hydraulic levers or air controls are in the correct positions, and the cathhead rope is not on the cathead before starting a drill rig engine.
- b.) Start all engines according to the manufactures manual.

PROCEDURES & PRECAUTIONS

Having and following Standard Operating Procedures for critical tasks plays an important role in the Sonic Drilling Ltd. safety program. Employees are expected to know the details of all Standard Operating Procedures that relate to their job duties.

Raising the Drilling Tower - Before raising the drilling tower, the operator must observe the following precautions:

- The surface that the levelling stabilizers will rest on must be reasonably even.
- The surface that the stabilizers will rest on must be able to adequately support the weight of the drill rig. If the surface is soft, timber or boards must be used under the stabilizers in order to spread the weight over a larger area.
- On a sloping surface the stabilizers must be able to extend far enough so that the drill rig is level. Blocking or timbers under the stabilizers may be necessary to meet this condition.
- If possible, the operator should avoid lifting the drill rig completely off of the ground with the stabilizers. It is preferable to have the wheels support some of the weight of the drill rig.
- The drill rig must be level.
- Clearance from overhead obstructions including buildings, bridges, power lines and other overhead utilities must be established. Legal offsets from overhead power lines must be observed and measured prior to raising the tower. Both supervisors and members of the exploration must take special precautions when a drill rig will be used on a site or project within the vicinity of electrical power lines and other utilities. Electricity can shock, burn and cause death.
- Clearance from underground utilities must be established. Although it is the responsibility of the client to locate all underground utilities, the operator has responsibilities to be observant and to look for indicators of possible underground utilities such as storm drains, manhole covers, natural gas meters, ect.
- Locate, note and emphasize overhead and buried utilities on all boring location plans and boring assignment sheets. When overhead electrical power lines exist at or near drilling site consider all wires to be alive and dangerous. Watch for sagging power lines before entering a site. Do not lift power lines to gain entrance. Call the utility and ask them to lift or raise the lines or turn off power. Before raising the drill mast on a site in the vicinity of power lines, walk completely around the drill rig, determine the minimum horizontal distance from any point on the drill rig to the nearest power line when the mast is raised and/or being raised. IF this horizontal distance is less than 100ft , first consult the local utility company and refer to OSHA 1910.180 before commencing. Keep in mind that both hoist lines and overhead power lines can be moved toward each other by the wind. In order to avoid contact with power lines only move the drill rig with the mast down.
- If there are any questions concerning the safety of drilling on sites in the vicinity of overhead powerlines, call the power company. The power company will provide expert advise at the drilling site as a public service and at no cost.
- The pins that secure the tower when it is the raised position must be removed until after the tower is raised.

Note: Since it is impossible for this manual to cover every possible hazard one might encounter on the job, please use common sense when working.

Once the drill rig is levelled with the stabilizers, the drill head must be moved to or below the pivot point of the tower. Under no circumstances should the operator attempt to raise the tower with the drill head above the pivot point of the tower.

When the operator is confident that the ground surface is supporting the stabilizers (ie. Not sinking into the ground) and when the drill head is at or below the tower pivot point, the operator may raise the tower. As the tower is being raised, operator must scan the entire tower to insure that there is no interference with people, equipment, buildings or utilities. If the operator observes any interference or potential interference between the tower and any object or person, the operator must stop raising the tower and re-evaluate the situation.

Once the tower is raised to its full upright position and the operator is satisfied that tower is safe operating distance from structures and is the legal distance from overhead power lines, the tower securing pins should be put in place.

After the tower is secured with the tower securing pins and all safety conditions have been met, the drill head may be moved up the tower and drilling may proceed.

Sonic Drill Rig OPERATIONS CHARTS

SETTING UP THE DRILL RIG

WHAT TO DO	WHO DOES IT	HOW TO DO IT	COMMENTS
1. Hold a pre-job safety meeting	All personal on site	Complete the Daily Safety Review (DSR)	Insure that all underground and overhead utilities have been checked
2. Perform daily inspection of drill rig	Driller	Follow the daily inspection checklist	
3. Locate the drill rig on the spot designated by the client	Driller Driller's Assistant should guide the driller	Drive the drill rig so that it is located on the spot	The driller should inspect the location for accessibility
4. Lower the stabilizers and level the drill rig	Driller	Adjust the stabilizers so that the rig is level. Use the bubble level as a guide	Insure that all stabilizers are firm ground Blocking may be required
5. Position the Drill Head	Driller	Position the Drill head lower than the pivot point of tower	The Drill head must be lower than the tower pivot point
6. Raise the tower	Driller	Raise the tower	Insure that the limits
7. Secure the tower	Driller's Assistant	Activate or insert the tower securing pin(s)	

LOWERING THE DRILL TOWER

WHAT TO DO	WHO DOES IT	HOW TO DO IT	COMMENTS
1. Position the drill head	Driller	Position the drill head so that it is lower than the tower pivot point	
2. Remove the tower securing pins	Driller's Assistant	Remove the tower securing pin(s)	
3. Lower the tower	Driller	Lower the drill tower	The tower must never be lowered with the drill head above the tower pivot point
4. Prepare to move the drill rig	Driller	Raise the stabilizers Position the drill head just behind the cab of the truck	The stabilizers must be fully retraced when travelling on public roads or at speeds greater than 30km/h

Note: Since it is impossible for this manual to cover every possible hazard one might encounter on the job, please use common sense when working.

The operator must insure that all drill rod, core barrels, casing and drill bits disconnected from the drill head. All drilling guides and collars must be removed from the drilling table. The drill head must be lowered so that it is at or below the drilling tower pivot point. The tower securing pins must be removed.

CONNECT DRILL PIPE (ROD OR CASING)

1. Raise the drill head	Driller	Raise the drill head so that it is about 11ft above ground level Angle the drill head so that it is about 20 from vertical	
2. Stand-Up the drill pipe	Driller's Assistant	Lift the female end of the pipe Push the pipe until it is about 10 past vertical	Use proper lifting techniques Insure secure footing
3. Attach drill pipe to drill head	Driller	While rotating the swivel clockwise, lower the drill head so that the threads contact the drill pipe	Insure that the angle of the drill head is the same as the angle of the drill pipe
4. Position the drill pipe in the drill table	Driller	Once the drill pipe is connected by 3 threads, raise the drill head and position it vertically above the drill table. Lower with at least 6in of the pipe into the table	
5. Tighten the drill pipe	Driller	Clamp the pipe with the break-out table jaws Rotate the pipe until tight	

BREAKING A DRILL PIPE JOINT

WHAT TO DO	WHO DOES IT	HOW TO DO IT	COMMENTS
1. Position the pipe joint	Driller	Raise or lower the drill pipe unit it is in between the two levels of break-out jaws	
2. Clamp the lower pipe	Driller	Clamp the lower pipe with the lower break-out jaws	
3. Clamp the upper pipe	Driller	Clamp the upper pipe with the upper break-out jaws	
4. Break the pipe joint	Driller	Rotate the upper breakout jaws until the pipe joint breaks	Insure that the upper and lower break out jaws are on the upper and lower pipes respectively
5. Position the drill pipe for removal	Driller	Raise the drill head so that the pipe clears the drill table. Angle the drill head at about 20 from vertical and lower the drill head until the pipe is 6in from the ground	Insure that the Assistant is not in the swing out zone.
6. Remove the drill pipe	Driller's Assistant	The Assistant holds the pipe until detached then drops the pipe on a block	Insure that no one is in the drop zone

COUNTERSINK FOR A WELL PROTECTOR

WHAT TO DO	WHO DOES IT	HOW TO DO IT	COMMENTS
1. Position the countersinking tool	Driller's Assistant	Centre the countersinking tools under the drill table	The Assistant should avoid positioning their head to be under the drill pipe or drill head
2. Attach the countersinking tool	Driller	Lower the drill head until the drill pipe contacts the tools Rotate until tight	Insure that the pipe does not cross-thread
3. Countersink	Driller	Using full rotation. Moderate oscillation and minimal feed pressure, cut into the ground surface	Oscillation may have to be adjusted if cutting though concrete
4. Remove cuttings	Driller's Assistant	Lift the drill head frequently and clear cuttings away	The Assistant should avoid placing their hands under the countersinking tool
5. Inspect	Driller or Driller's Assistant	Dust and cuttings should be cleared away and the outer edge of the hole inspected	The outer edge of the hole should be at least 05in into the surface
6. Remove the countersinking tool	Driller and Driller's Assistant	Same as 'Breaking a Pipe Joint'	

MATERIAL HANDLING

Accidents while handling materials is the most likely source of injury for Sonic Drilling Ltd. employees. Muscle strains, pinched fingers, and metal slivers can occur during drilling operations.

The following steps can be taken to reduce the risk of injuries when handling drill pipe and other heavy items:

- Do not lift anything that may exceed your abilities. Always get assistance when lifting heavy items.
- Always use safe lifting practices when lifting heavy items.
- Be very conscious of the placement of your hands and fingers are when you are handling drill rod and casing. Make sure that hands and fingers are not placed in vulnerable locations between drill pipe and solid objects.
- Burrs on drill pipe should be flattened with a hammer or removed with a grinder.

The following steps can be taken to reduce the risk of injury when handling hazardous materials:

- Employees must insure that they are familiar with the Material Safety Data Sheets (MSDS) for all materials that they handle in the course of their job, including: solvents, fuels, hydraulic fluids, lubricating oils, cement products, and bentonite products.
- Materials that are vapour harmful, including gasoline and solvents, must be handled in well-ventilated conditions.
- Fuels, such as gasoline and diesel fuel, must never be used as cleaning solvents.

Anyone who enters a hazardous waste site must recognize and understand the potential hazards to health and safety associated with the clean up of that site.

Employees must be conscious of spill response when handling and storing hazardous liquids. Each drill rig should have 1 bag of sorbent material and several sorbent pads available in the event of a spill of any hazardous liquid.

Material and Inventory in the yard

Sonic Drilling Ltd. **Buy's bits and tooling from Sonic Drill Mfg. Please notify** office manager if we are low on any item. Core bits, Casing bits and tooling are kept in the workshop. These are no to be taken unless directed by operations manager. Please leave a note of request if the operations manager is not in.

INCIDENT ANALYSIS AND FOLLOW-UP

Regardless of the procedural, engineering, and personnel controls implemented, there will always be the **possibility of worker injury or equipment failure. In the event of an 'incident', an analysis or investigation** must be conducted to minimize the chance that the same situation will occur again.

There are varying degrees of incident seriousness. Minor incidents, referred to as Class II, must be recorded and reported. Serious incidents, referred to as Class I, must be recorded, reported, and investigated. In both situations, an Incident Report must be completed.

INCIDENT REPORTING

The following Class II situations must be recorded and reported:

- A minor worker injury that requires some first aid but is not a Lost Time Accident.
- A minor mechanical failure or breakdown.
- A workplace hazard that does not pose an immediate threat to worker health and safety, however is a situation that should be corrected or improved.

Work must halt until the situation is recorded and/or corrected.

The following Class I situations must be recorded, reported, and investigated:

- an incident in which there was serious injury.
- a major structural or mechanical failure.
- a workplace hazard that does pose an immediate threat to worker health and safety.

Work must halt until the worker is tended to, or the mechanical failure is repaired, or the hazard is **corrected. In all situations, an 'Incident Report' must be completed and the General Manager must be notified.** An investigation must ensue within 24 hours.

An incident that is classified as a Lost Time Accident or requires medical treatment must be reported to the **Workers' Compensation Board. A WCB Form 7 must be completed and submitted to the WCB within 72** hours of the accident.

INCIDENT INVESTIGATION

Class II incidents must be investigated. An incident investigation must be conducted by the General Manager and an employee, ideally a witness to the incident. The investigation should encompass the points covered in the Incident Report but contain more detail.

The investigation should clearly identify the following items:

- a) The location, date, and time of the incident.
- b) The personnel involved in the incident.
- c) A description of the incident, based on interviews with all witnesses.
- d) The result of the incident including injury, equipment damage, or other damage.
- e) The cause of the incident. This point must be thorough and detailed. It is essential that all causes be identified so that they can be removed or remedied.
- f) Prevention of recurrence. The causes of the incident must be clearly identified so that procedural and/or engineering changes can be made to reduce the chance that a similar incident will occur again.

INCIDENT FOLLOW-UP

All situations that require an Incident Report must also be followed-up. The purpose of the follow-up is to assess the effectiveness of the engineering, procedural, or personnel changes and/or corrections.

- ◆ Class I incidents must be followed-up one week and one month after the original incident.
- ◆ Class II incidents must be followed-up two weeks after the original incident.
- ◆ If the incident was the result of a procedure failure, the effectiveness of the procedural changes must be assessed during the follow-up. Further changes may be made to the procedure as a result of the follow-up.
- ◆ If the incident was the result of a mechanical failure, the effectiveness of the mechanical modifications or repairs must be assessed during the follow-up. A close and thorough inspection must be performed to insure that the risk of a similar incident be minimized.
- ◆ If the incident was the result of a problem with an employee, the effectiveness of the corrective measures and/or disciplinary actions must be assessed during the follow-up.

OVERHEAD AND BURIED UTILITIES

The use of equipment on a work site within the vicinity of electrical power lines and other utilities requires special precautions to be taken by both operators and members of the crews. Electricity can shock, burn and cause death.

1. Before working with equipment at a site, look up to check for overhead obstructions.
2. Overhead and buried utilities should be located, noted and emphasized prior to the start of all jobs.
3. If a sign warning of underground utilities is located on a site boundary, do not assume that underground utilities are located on or near the boundary of property line under the sign, the utilities may be a considerable distance away from the warning sign.
4. Always make sure that the owners of utility lines or the nearest underground utility location service have been contacted before working. Determine jointly with client or utility personnel the precise location of underground utility lines, mark and flag the locations and what specific precautions must be taken to assure safety.
5. When overhead electrical power lines exist at or near a work site or project, consider all wires to be alive and dangerous.
6. Equipment, or any part, does not have the capability of coming within the following minimum clearance from energized overhead lines, or the equipment has been positioned and blocked to assure no part, including cables, can come within the following minimum clearances.

POWER LINES Nominal System kv	MINIMUM Required Clearance
50 or under	10 feet (3.05 m)
69	12 feet (3.66 m)
115,161	15 feet (4.57 m)
230, 285	20 feet (6.10 m)
345	25 feet (7.62 m)
500	35 feet (10.67 m)

7. Watch for sagging power lines before entering a site. Do not lift power lines to gain entrance. Call the utility and ask them to lift or raise the lines or de-energize (turn off) the power.
8. Keep in mind that both hoist lines and overhead power lines can be moved toward each other by wind.
9. If there are any questions whatsoever concerning the safety of working on sites in the vicinity of overhead power lines, call the power company and they will provide expert advice at the work site at no cost.
10. Underground electricity and gas are as dangerous as overhead electricity. Be aware and always suspect the existence of underground utilities such as electrical power, gas petroleum, telephone, sewer and water. Ask for assistance.
11. If there are any questions whatsoever concerning the safety of working on sites in the vicinity of overhead power lines, call the power company. The power company will provide expert advice at the work site as a public service and at no cost.

ELECTRICITY

1. Only authorized and qualified personnel are allowed to make electrical connections or repair electrical equipment or wiring.
2. Respect loose or exposed wires. All wires must be considered as being alive until it is positively known that they are dead. Do not touch any exposed or dangling wires that you may encounter; report them to your supervisor.
3. Do not use extension cords that are defective. They can cause electric shock or death. Examine them carefully for worn insulation, exposed strands of wire or other defects before using them. Do not drag cords across sharp edges or across aisles where equipment can damage them. Do not create a tripping hazard with extension cords.
4. Never handle energized power cords with wet hands.
5. Never allow extension cords or plug connections to lay in water or other liquid.
6. When repairing, adjusting or otherwise maintaining electrical equipment, all power must be disconnected to prevent the machine or equipment being set in motion by lockout or tagout.

Sequence of lockout or tagout system procedure:

1. Notify all affected employees that a lockout or tagout system is going to be utilized and the reason why. The authorized employee shall know the type and magnitude of energy that the machine or equipment utilizes and shall understand the hazards.
2. If the machine or equipment is operating, shut it down by the normal stopping procedure (depress stop button, open toggle switch, etc.).
3. Lockout and/or tagout the energy isolating devices with assigned individual lock(s) or tag(s).
4. After ensuring that no personnel are exposed and as a check on having disconnected the energy source, operate the push button or other normal operating controls to make certain the equipment will not operate.
5. The equipment is now locked out or tagged out.

Restoring machines or equipment to normal production operations:

1. After the serving and/or maintenance is complete and equipment is ready for normal production operations, check the area around the machines or equipment to ensure that no one is exposed.
2. After all tools have been removed from the machine or equipment, guards have been reinstalled and employees are in the clear, remove all lockout or tagout devices. Operate the energy isolating devices to restore energy to the machine or equipment.

REACT TO CONTACT WITH ELECTRICITY *If a rig makes contact with electrical wires, it may or may not be insulated from the ground by the tires of the carrier. Under either circumstance the human body, if it simultaneously comes in contact with the drill rig and the ground, will provide a conductor of the electricity to the ground. Death or serious injury can be the result. If a rig or a rig carrier makes contact with overhead or underground electrical lines:*

1. Under most circumstances, the operator and other personnel on the seat of the vehicle should remain seated and not leave the vehicle. Do not move or touch any part, particularly a metallic part, of the vehicle or the rig.
2. If it is determined that the rig should be vacated, then all personnel should jump clear and as far as possible from the rig. Do not step off the vehicle, but rather jump off and do not hang onto the vehicle or any part of the rig when jumping clear.
3. If you are on the ground, stay away from the vehicles and the rig, do not let others get near the vehicle and the rig and seek assistance from local emergency personnel such as the police or fire department.
4. When an individual is injured and in contact with the rig or with power lines, attempt rescue with extreme caution. If a rescue is attempted, use a long, dry, unpainted piece of wood or a long, dry, clean rope. Keep as far away from the victim as possible and do not touch the victim until the victim is completely clear of the rig or electrical lines.
5. When the victim is completely clear of the electrical source and unconscious, and a heartbeat (pulse) cannot be detected, begin cardiopulmonary resuscitation (CPR) immediately.

Note: Since it is impossible for this manual to cover every possible hazard one might encounter on the job, please use common sense when working.

PROPER LIFTING TECHNIQUES

Proper lifting takes the hazard out of moving heavy objects. Whenever you lift something:

1. Make sure you can lift the load safely, otherwise get help.
2. Use a mechanical lifting device, if available.
3. Inspect route to be traveled, making sure of sufficient clearance.
4. Look for any obstruction or spills.
5. Inspect the object to decide how it should be grasped.
6. Look for sharp edges, slivers, or other things that might cause injury.

PROPER LIFTING PROCEDURES

1. Keep feet parted - one along side and one behind object for better balance,
2. Keep back straight, vertical, with spine, back muscles, and body in correct alignment,
3. Tuck chin into chest,
4. Bend knees and assume squatting position,
5. Tuck elbows and arms close to body,
6. Keep body weight directly over feet,
7. Start lift with thrust of rear foot,
8. Move slowly and carefully, avoid twisting the body.

FIRE AND CHEMICAL SAFETY

1. Fire extinguishers in good condition will be on all Company vehicles.
2. All employees shall know the location of the FIRE fighting EXTINGUISHERS and how to use them properly.
3. Do not remove, alter or deface any HAZARD WARNING LABELS.
4. Change your clothing immediately should it become soaked with any flammable liquid or chemical.
5. Never pour FLAMMABLE LIQUIDS down drains or sewers.
6. Store flammable liquids in proper containers in separate area with warning labels.
7. Use metal containers for disposal of rags soaked with flammable liquids.

AUDIT

An audit is an effective method of monitoring company operations and procedures. An audit insures that all aspects of the company are operating in compliance with company rules and procedures as well as in compliance with laws and regulations. Inadequacies and violations can be identified and corrected.

The Manager must complete a thorough company self-audit yearly. All procedures, rules, and policies must be assessed for safety and effectiveness.

The Manager should perform random inspections or audits of each drill crew. These random audits should be performed approximately every month.

Any inadequacies identified in an audit should be assigned a time frame for correction. The time frame may be immediate or it may be a few months, depending on the nature of the inadequacy.

MANAGEMENT OF CHANGE

The purposes of company audits are to identify inadequacies in company policies and procedures. The purposes of incident reports are to record and analyze hazardous and potentially hazardous situations. The audit and the incident report serve to recognize inadequacies and correct them. It is then crucial that the corrections be conveyed to company employees.

Sonic Drilling Ltd. is a growing organization. As the company grows, the need for formalization and structure within company policies will likely increase. Employees will be kept informed of changes with the following methods:

- Monthly safety meetings.
- Safety flyers issued with pay cheques.
- Changes to official policies or rules will be issued so that employees can update their own company handbooks.

Safety meetings will allow management and employees to exchange ideas with the common goal of improving the safety and working conditions for all employees.

Safety flyers will serve to notify employees of current health and safety issues, including bulletins issued by clients and competitors.

Changes to official policies and rules will likely be the result of management and employee communication, or the result of an incident. Changes to company policies must first be carefully considered by the Manager and thoroughly discussed with employees. Once approved, official changes will then be issued as replacement pages for the employee manuals.

CONFIDENTIALITY

Except as otherwise required by federal and provincial laws concerning reporting all information, interviews, reports, statements, memoranda and test results are confidential communications that will not be released.

PROHIBITIONS

The following conduct is prohibited:

- ◆ Use or possession of alcohol beverages, controlled substances, drugs or drug paraphernalia on company property, while operating company equipment or while otherwise on company business.
- ◆ Entering onto company property, working or reporting to work, operating a company vehicle while under the influence of alcohol or identifiable traces of a controlled substance or drugs in the persons system.
- ◆ Violating any applicable local, provincial or federal law or regulation that relates to alcoholic beverages, drugs or controlled substances while engaging in any activity while on company business.

DRUG AND ALCOHOL POLICY

Employees must not be under the influence of any mind or perception altering substances while on company time, or while operating any company vehicle or equipment. Forbidden substances include, but are not limited to: alcohol, pain relievers that induce drowsiness, cold medications that induce drowsiness, and any illegal drugs. In the event that any SDL employee becomes impaired at an SDL social function, the employee must arrange transportation home, either with a driver that is not impaired, or by taxi at the expense of SDL. In addition, it is the responsibility of each employee to insure that they, and their coworkers, are healthy and alert and are able to perform their respective jobs. Employees that appear not to be fit for duty, due to illness etc., should not be on site.

DRUG AND ALCOHOL TESTING

All persons who have been extended an offer of employment by the company are subject to testing. Any person who fails a pre-employment test is not eligible for hire at any time in the future. An employee who is rehired by the company or who is returning from any extended leave is subject to the same pre-employment testing. Employees and other persons may be tested when a reasonable person would have cause to believe that the suspected person may be in violation of the policy through their job performance or behaviour, an incident while on company business, some other relevant and specific indication. In all cases, the company manager will review the facts before deciding to conduct such reasonable suspicion testing. Periodic unannounced testing of employees or other persons may be performed at the discretion of the company. Any employee found to be in breach of the policy is subject to discipline up to and including termination, even for a first offence.

DISCIPLINARY POLICY

It would be preferable that all employees follow the company safety program so that disciplinary confrontations could be avoided. However, it may be necessary on occasion to gain employee compliance with the company safety program or other regulations through disciplinary measures.

Before disciplinary actions are taken, it is essential that the employee is aware of the company safety rules and of the consequences for non-compliance. Each situation will be different so the severity of the infraction will be determined by the Manager. All disciplinary actions must be documented by the Manager. The following are the guidelines for disciplinary actions:

Verbal Warning

The Manager and the employee will discuss the problem privately. The Manager will explain what policy has been violated and why the policy is in place. A plan for corrective action will be discussed. The Manager will decide on the number of verbal warnings given before an incident report is completed.

Written Warning

The Manager will complete an incident report describing the infraction and have the employee sign the report to acknowledge that disciplinary action has been taken. Again, a plan for corrective action will be discussed. A written warning must be followed-up by the Manager.

Discharge

The employee will be given a letter explaining the reason for discharge.

CELL PHONE BAN EFFECTIVE OCTOBER 2005

All employees have been notified in writing about the cell phone ban that now is in effect. While any company vehicle is in motion, employees are not allowed to use a company or personal cellular while driving a company vehicle or a personal vehicle on company time.

Disciplinary action will be taken if it's found that this company policy is not being followed.

SUPPORT TRUCK INVENTORY

A well-prepared crew is an efficient crew. Having all of the necessary equipment, tools, and supplies when you arrive on site is absolutely essential. In addition, returning tools to their proper places helps to keep the work site safe and makes your job easier. All support trucks must have a minimum of the following equipment, tools, and supplies at all times:

<p><u>Safety Supplies</u></p> <ul style="list-style-type: none"> 1 box ear plugs 10 pairs nitrile coated safety-cuff work gloves 1 box nitrile glove liners 4 pairs organic vapour respirator cartridges 4 pairs respirator cartridge pre-filters 6 pairs polyethylene coated Tyvek coveralls 2 rolls "CAUTION" tape 6 - 3' high traffic markers <p><u>Drill Tooling (minimum quantities)</u></p> <ul style="list-style-type: none"> 7 - 10' drill rods 1 - 5' drill rod 1 - 3' drill rod 5 - 10'X6" casing 2 - 5'X6" casing 3 - 4.75"X11' core barrels 5 - 4.75" core bits (excluding bits on core barrels) 2 - 4.75" displacement bits 1 - 4.75" open-end displacement bit 1 - 4.75" core catcher bit 4 - 4.75" core catchers 1 - 6" casing bit (excluding bit on lead casing) 1 - 6" displacement bit 	<p><u>Well Materials and Supplies (minimum quantities)</u></p> <ul style="list-style-type: none"> 2" PVC well materials: 20 - 10' PVC solid pipe 10 - 10' PVC slotted pipe 10 - 5' PVC solid pipe 10 - 5' PVC slotted pipe 20 threaded end plugs 10 slip caps 5 slip couplings 10 threaded female caps 10 threaded male adapters 10 J-plugs 10 Enviro-caps 3 Enviro-cap keys 10 flush-mount well protectors 3 well protector tools 3 stick-up well protectors 2 - 205L reconditioned steel drums 10 bags bentonite chips 5 bags "Post Haste" pre-mix rapid-set concrete silica filter sand, as required bentonite grout, as required drilling polymer, as required
<p><u>Hand Tools</u></p> <ul style="list-style-type: none"> 1 - 36" pipe wrench 1 - 8lb sledge hammer 1 - 3lb drilling hammer 1 fire hydrant wrench 1 scoop shovel 1 digging shovel 1 heavy-duty floor broom 1 posthole hand auger 1 long digging/prying bar 1 short digging/prying bar 1 wheelbarrow 1 small gardening shovel 	<p><u>Other Equipment</u></p> <ul style="list-style-type: none"> 2 - 25' suction hoses, with camlock connectors 1 - 10' suction hose, with camlock connectors 1 double check valve, with gate valve 1 - 15'X1.5" fire hose 1 - 25'X1.5" fire hose 1 - 50'X1.5" fire hose <p><u>Other Supplies</u></p> <ul style="list-style-type: none"> 1 roll sorbent pad

HEAVY TRUCK INVENTORY

A well-prepared employee is an efficient employee. Having all of the necessary equipment, tools, and supplies when you are operating a company truck helps insure that you will arrive at your destination safely and on time. If there are minor problems, you are prepared.

It is also very important to keep your vehicles tidy and organized. This will insure that you always know the locations of your tools, equipment, and safety supplies.

A heavy truck is defined as any vehicle with a G.V.W. of greater than 5000kg. All heavy trucks must have a minimum of the following equipment, tools, and supplies at all times:

<p><u>Safety Equipment</u> (see section 3.5 of the Safety Manual)</p> <ul style="list-style-type: none"> 1 set safety reflectors or flares 1 - 10lb ABC fire extinguisher (20lb required on drill rigs) 1 Basic first aid kit (Level 1 kit required on drill rigs) 2 pairs leather gloves 4 - 18" traffic cones 	<p><u>Hand Tools</u></p> <ul style="list-style-type: none"> 1 set combination wrenches, ¼" to 1" in 1/16" increments, and/or metric if required socket set(s), ¼" to 1" in 1/16" increments, and/or metric if required 1 - 10" adjustable wrench 1 large pair locking pliers (Vise-Grips - 10WR) 1 pair needle-nose pliers 1 pair side cutters 1 airbrake adjustment tool, if required 1 multi-tip screwdriver a few assorted slot screwdrivers 1 set hex keys, if required 1 claw hammer 1 electrical crimping/stripping tool 1 circuit tester light 1 tire pressure gauge
<p><u>Supplies</u></p> <ul style="list-style-type: none"> 1 can WD40 spray lubricant 1 can lock de-icer 1 can starting fluid (ether) 2 minimum of each fuse used in the vehicle 2 minimum of each light bulb used in the vehicle (excluding headlights) assorted electrical terminals, connectors, and wire 2 driver's log books 2 daily vehicle inspection books 	<p><u>Other Equipment</u></p> <ul style="list-style-type: none"> 1 complete set of spare keys hidden under the vehicle 1 - 20' piece of 3/8" grade 70 chain, with grab hooks 1 - 25' coil air hose, with tire chuck (if equipped with airbrakes) 1 set heavy-duty jumper cables 1 flashlight 1 current edition of the Greater Vancouver & Fraser Valley Map Book published by Street Wise

DRILL RIG INVENTORY

A well-prepared crew is an efficient crew. Having all of the necessary equipment, tools, and supplies when you arrive on site is absolutely essential. In addition, returning tools to their proper places helps to keep the work site safe and makes your job easier. All drill rigs must have a minimum of the following equipment, tools, and supplies at all times:

<p><u>Safety Equipment</u></p> <ul style="list-style-type: none"> 1 set of the WCB Occupational Health and Safety Regulations 1 complete set of Material Safety Data Sheets (MSDS) 1 spare hard hat 1 spare high-visibility vest 	<p><u>Hand Tools</u></p> <ul style="list-style-type: none"> 1 hacksaw 5 razor knives 1 - 12" (or larger) adjustable wrench 1 set of combination wrenches, 1" to 1 ½" in 1/16" increments 2 - 12" pipe wrenches 1 - 30m fibreglass measuring tape 1 - 50m fibreglass measuring tape spare measuring tape weights 1 grease gun 1 wire brush
<p><u>Drill Tooling</u></p> <ul style="list-style-type: none"> 1 - 10" well protector countersinking tool 2 - 2'X6" casing 1 - 4.5" guide 1 - 6 5/8" guide <p><u>Power Tools</u></p> <ul style="list-style-type: none"> 1 - disc grinder, with grinding and cut-off discs 1 - ½" drive air impact wrench with 1 - ¾" deep impact socket 1 air sander with cut-off wheel (for down-hole well trimming), with extra cut-off wheels <p><u>Other Equipment</u></p> <ul style="list-style-type: none"> 1 stabilizer pad for each stabilizer assorted blocks and timbers 	<p><u>Supplies</u></p> <ul style="list-style-type: none"> 1 clip board, with extra Daily Work Records and Timesheets 2 <u>full</u> rolls core bag 1 tub non-petroleum thread grease, with brush at least 2 sets (male and female) of hydraulic fitting caps of each size up to No. 16 assorted hydraulic fittings assorted nuts and bolts assorted hitch pins assorted clevis pins assorted tie straps arc welding mask arc welding rods (#7014) hard-face arc welding rods

The following is a sample DAILY WORK RECORD it is required to meet the following specifications:

IMPORTANT notes to consider when filling your daily work record out:

- a) Please use Black or Blue INK !!! no color pens
- b) Please print clearly and accurately for the office to properly bill out work.
- c) **Employee's need to print their initials in full (i.e. M. O. P.)** under Driller / Assistant
- d) Make sure that you have your site address completed ***always include the city !!!
- e) Have the Site Rep. Print there name clearly beside there signature, including their LAST name!
- f) Use separate work records for more than one project, even if it is the SAME site address.
- g) Please specify your material
- h) Note the PVC size used for the install under each hole numbered
- i) Always record your drilling times under 24 Hours
- j) Break down or Repair to rig is not "standby" time. Please write this time under "comments"
- k) **If a courier has brought materials to your project please note under 'freight' Make note of the waybill # if possible**

DAILY WORK RECORD

Client : _____ Date: _____
 Site: _____ Drill Rig No: _____
 Site Address: _____ Driller _____
 Site Representative: _____ Assistant _____
 Client Project No.: _____ Project No. : _____

DRILLING DETAILS	1	2	3	4	5	6	7	8	9	10	11	12	13	14	Totals
4" Core / Displace															
6" Core / Displace															
8" Core / Displace															
10" Core / Displace															
12" Core / Displace															
Install															
Difficulty (1-5)															
MATERIALS	1	2	3	4	5	6	7	8	9	10	11	12	13	14	Totals
PVC SIZE INSTALLED															
Threaded End Plug															
Pointed End Plug															
Slip Cap															
2" Slotted PVC															
5" Slotted PVC															
10" Slotted PVC															
Sand															
Bentonite (chip/pell)															
Bentonite Grout															
Cement, Type 10															
Concrete															
Cap & Adapter															
J Plug / Enviro Cap															
WellProtector (F/S/C)															
Drum															
Disposable Coverall															
Respirator Cartridge															

Comments: _____

Freight (Yes/No) Carrier: _____

VEHICLE OPERATION

Sonic Drilling Ltd. is committed to complying with all federal and provincial regulations governing the safe operation of vehicles. Driver training, vehicle inspection and maintenance, and regulatory compliance combine to form a complete vehicle safety program.

USE BASIC ROAD SENSE!!

- Wear your seat belt, it is the single most important safety device in most vehicles.
- Keep alert to changes in traffic and road conditions.
- Report any mechanical or operating problem to your supervisor for repair

The manager is required to:

- **Keep a photocopy of each employee's driver's license on file.**
- **Request a Driver's Abstract from BC Motor Vehicle Licensing for each employee annually.**
- Insure that employees have the proper driver's license for the vehicle(s) that they are assigned to operate.

Employees are required to:

- Insure that they are properly licensed for the vehicle that they are operating.
- Insure that they are familiar with all of the requirements of the National Safety Code (NSC).
- Complete a daily vehicle Pre-Trip and Post-Trip Inspection for vehicles over 5500kg GVW.
- **Keep a Driver's Log while operating a vehicle, of more than 14700kg GVW, more than 160km from the main office.**

Employees are NOT permitted to:

- Operate any Sonic Drilling Ltd. vehicle while under the influence of any mind or perception altering substances. Forbidden substances include: alcohol, pain medications that cause drowsiness, cold medications that cause drowsiness, and any illegal drugs.
- Drive for more than 12 hours per day.
- Work for more than 15 hours per day, including driving, unless authorized by the General Manager.
- Use a radar or laser detector when operating a Sonic Drilling Ltd. vehicle.
- Operate a vehicle when they are excessively fatigued. Drivers must recognize that if they drive when they are not alert, they endanger themselves, company equipment, and the general public.

SERVICE & SUPPORT VEHICLES

We ask that employee's who are driving service and support vehicles please do not drive with your hand sitting on the gear shift; The shifting forks are effected when this is done in habit.

NATIONAL SAFETY CODE FOR MOTOR CARRIERS

PURPOSE

The national safety code for motor carriers (NSC)

EMPLOYEE ASSISTANCE AND PREVENTION PROGRAMS

An Employee Assistance Program is an employer-sponsored benefit that provides confidential, professional counselling and advisory services for employees and their families. An EAP assists employees by acting as a prevention treatment resource for individuals who are experiencing personal difficulties. The kind of problems that are covered are: Couple and marital relationships, Family matters, Work-related and career issues, Depression, Stress and anxiety, Bereavement, Misuse of alcohol and drugs, Crisis financial and legal. The program is voluntary, confidential, short term counselling, advisory and information service available to employees and their families. A councillor at 1-800 is available 24hr/7days to help and direct him/her to councillors in their area.

Companies enrolled will submit a list of employee names that are covered under the program. The company pays a fee of \$7.29 per person to maintain coverage and \$100 annually.

Testing and Prevention – CAP Program

SUMMARY

- Follow Instructions. **If you don't know, ask!**
- Stop and think before you act, perform a pre-work risk assessment
- Immediately report any unsafe conditions.
- **Keep all work area's clean and tidy**
- Use the right tools and equipment for the job
- Report all incidents promptly
- Attend to First Aid immediately
- Wear appropriate PPE for the job
- Obey the rules, signs and regulations

SONIC EMPLOYEE ACKNOWLEDGEMENT OF HEALTH AND SAFETY RULES

This is to acknowledge that I have received and reviewed a copy of the Sonic Drilling Ltd. "Occupational Health and Safety Program" AND "Employee Health and Safety Manual". I understand these rules and agree to comply with them.

I further understand that failure to comply with these rules may jeopardize my employment or other contractual relationship with Sonic Drilling Ltd.

Employee Signature

Date

****this acknowledgement must be submitted to the office administration department at the time of hiring****



Sonic Drilling Ltd.

FALL PROTECTION PLAN INSTRUCTIONS

Each employer must ensure that a fall protection system is used when work is done at a place from which a fall of 3 m (10 ft) or more may occur, or where a fall from a height of less than 3 m involves a risk of injury greater than the risk of injury from the impact on a flat surface.

A written fall protection work plan must be implemented by each employer on a job site where a fall hazard of 7.5 m (25 ft) feet or greater exists in accordance WCB Regulations.

The plan must be completed for each specific work site.

THIS WORK PLAN SHALL BE MADE AVAILABLE ON THE JOB SITE FOR INSPECTION AT THE WORKPLACE BEFORE WORK WITH A RISK OF FALLING BEGINS.

Attached is a sample fall protection work plan that may be filled out by each employer who has employees exposed above 10 feet. The following steps will help you fill out your plan.

(REMEMBER: You must complete and customize this form to site specific requirements)

1. FILL OUT THE SPECIFIC JOB INFORMATION.

Contractor/Trade Name: Address: City: Prov.

Job Site Name: Address: City: Prov.

Job Foreman: Phone: Safety Coordinator Phone:

_____/_____/_____
Project Start Date:

Safety Management Approved

2. FALL PROTECTION WORK PLAN (Site Specific)

NOTE: The plan form and individual site plans must accurately describe the conditions at your worksite and the methods you will use. A safety officer will, in addition to ensuring that your plan contains all the required elements, determine if it describes what you actually do. If it does not, you may be subject to disciplinary action as per **Sonic Drilling Ltd** Safety Policy, WCB Regulation order, and/or monetary penalty(s).

Fall Hazard Identification and Protection Selection Worksheet

On the table below, identify each fall hazard of 10 feet or more that exists or will exist during this construction project and then select the protection method from the options identified below the table.

√	Hazard Type	General Location(s)	Fall Protection Method	Overhead Protection Method
	Roof > 4/12 Pitch			
	Roof < 4/12 Pitch			
	Skylight Openings			
	Roof Openings			
	Floor Openings			
	Window Openings			
	Open-sided Floors			
	Decks			
	Balconies			
	Leading Edge Work			
	Scaffold Work			
	Mobile Lift Work			
	Ladder Work			
	Excavation Edges			

Fall Protection Methods: Select a fall protection method from the list below for each hazard identified above. Assembly and implementation instructions for the method(s) used are located elsewhere in this document.

(See next page for regulation assistance in selecting a method of fall protection).

Standard Guardrails	Fall Restraint	Fall Arrest	Cover or Hatch
Horizontal Lifeline	Control Zone	Safety Monitor	Safety Net
Toe boards	Toe Holds	Barricades	Hazard Signs

Other: _____

SELECTING A METHOD OF FALL PROTECTION (G11.2-2)

Section 11.2 of the *OHS Regulation* prescribes a hierarchy of choices in subsections (2) to (5). This guideline explains the hierarchy of choices and gives examples of how the circumstances of the workplace affect the selection of fall protection.

The employer must use "guardrails . . . or other similar means of fall restraint" under subsection (2) if it is practicable for the work process. If it is not practicable, the employer can use another fall restraint system under subsection (3). However, the employer cannot use a fall arrest system under subsection (4) unless it is impracticable to use any fall restraint system under subsections (2) and (3). Only if it is impracticable to use a fall restraint or arrest system under subsections (2) to (4) or if the use of a fall arrest system will result in greater hazards is the employer permitted under subsection (5) to use work procedures alone to minimize the risk of injury to a worker from a fall.

Fall Restraint

Fall restraint normally means a fall protection system arranged such that a worker cannot fall lower than the surface on which the worker was supported before the fall started. For example, a personal fall restraint system for a worker on an elevated flat surface would be arranged so the worker could go up to the edge of the work surface, but not beyond the edge in the event of a slip or fall. The system, in the event of a slip or fall, would result in the worker landing on the work surface, and perhaps very close to going over the edge.

Other work positioning arrangements, such as a firefighter secured to an aerial ladder, or a tree trimmer or power line technician using a climbing belt and pole strap, will normally result in the worker going through some vertical drop in the event of a slip. To allow their fall protection to be considered as fall restraint, their equipment should be arranged to limit the vertical drop as much as possible, and in no case, should the total fall distance be more than 30 centimeters or (1 foot). A fall restraint system should only be used where a worker likely can regain footing or otherwise self-rescue immediately after a slip or fall. Fall protection equipment and components that are intended only for fall restraint applications should be clearly and permanently marked to indicate such a limitation.

Fall Arrest

If the equipment cannot be arranged to limit the vertical drop to 30 cm, then the personal fall protection system should be a fall arrest type, and the system will need to address the additional requirements for fall arrest. For example, section [11.4\(1\)](#) of the *OHS Regulation* requires workers to wear a full body harness or other harness acceptable to the Board when using a personal fall protection system for fall arrest. Further, the anchor the worker is connected to must meet the requirements of section [11.6\(3\)](#) of the *OHS Regulation*.

Equipment standards

Equipment used for a fall protection system must:

- (a) Consist of compatible and suitable components,
- (b) Be sufficient to support the fall restraint or arrest forces, and
- (c) Meet, and be used in accordance with, an applicable CSA or ANSI standard in effect when the equipment was manufactured, subject to any modification or upgrading considered necessary by the Board.

3. FALL PROTECTION SYSTEMS / MAINTENANCE AND INSPECTIONS

Fall protection systems will be assembled and maintained according to manufacturer's recommendations and instructions when using a manufactured system. A copy of those instructions shall be available on-site for reference. Any fall protection system used will meet all regulation requirements. Assembly and maintenance instructions unique to this worksite such as components, placement of systems, anchor points, areas where systems are particularly subject to damage, etc., are specified below.

Where selection for fall protection with regards to regulation hierarchy will not be practicable, indicate reason for this assessment in "Other Instructions" for each system accordingly.

Covers or Hatches (Must follow WCB guidelines as set out in **section 4.59 Floor & Roof Openings**)

- Be able to support twice the weight of employees and equipment that would be on it at the same time or twice the maximum axle load of the largest vehicle that would cross it.
- Be secured to prevent accidental displacement.
- Be marked with the word "Cover" or "Hole".

Material(s) used:

Locations/Other Instructions:

Standard Guardrails (Must follow WCB guidelines as set out in **sections 4.54 to 4.63 Guardrails**)

Post Material:

Rail Material:

Post Spacing (8' max):

Anchor Method:

Configuration and placement sketch attached?

Yes _____ No _____

Locations/Other Instructions:

Fall Restraint

(Must follow WCB regulation/guidelines as set out in **Part 11 Fall Protection**)

System Component List:

Anchor Point at this worksite:

Configuration and placement sketch attached?

Yes _____ No _____

Other Instructions:

Fall Arrest

(Must follow WCB regulation/guidelines as set out in **Part 11 Fall Protection**)

System Component List:

Anchor Point at this worksite:

Configuration and placement sketch attached?

Yes _____ No _____

Other Instructions:

Anchor(s)

(Must follow WCB regulation/guidelines as set out in **section 11.6 Anchors**)

Each personal fall protection system that is connected to an anchor must be secured to an independent point of anchorage. An anchor for a personal fall protection system must have an ultimate load capacity in any direction in which a load may be applied of at least...

- **Fall Arrest:** Ultimate load capacity in any direction of (5000 lbs)
- **Fall Restraint:** Ultimate load capacity in any direction of (800 lbs)

System Component Type:

Manufacturer

Instructions On site?

Configuration and placement sketch attached?

Yes _____ No _____

4. MAINTENANCE / INSPECTION / DISASSEMBLY PROCEDURE

Inspection and Maintenance (Must follow WCB regulation/guidelines as set out below)

Equipment used in a fall protection system must be

- (a) Inspected by a qualified person before use on each work shift,
- (b) kept free from substances and conditions that could contribute to its deterioration, and
- (c) Maintained in good working order.

Removal from Service

After a fall protection system has arrested the fall of a worker, it must

- (a) be removed from service, and
- (b) not be returned to service until it has been inspected and recertified as safe for use by the manufacturer or its authorized agent, or by a professional engineer.

Any defective equipment will be tagged and removed from use immediately.

Qualified Person(s) (List all trained and or qualified person(s) in Fall Protection)

Name of Qualified Person	Company	Position	Contact Phone
Professional Engineer	Company	Position	Contact Phone
Trade Safety Coordinator	Company	Position	Contact Phone

5. STORAGE & SECURITY OF TOOLS AND MATERIAL.

Toe boards (at least 4 inches in height) will be installed along the edge of all scaffolding and walking surfaces for a distance sufficient to protect employees below to prevent tools and equipment from falling from scaffolding. Where tools, equipment, or materials are piled higher than the top of the toe board, paneling, or screening will be erected to protect employees below. Other specific handling, storage and securing is as follows:

6. OVERHEAD PROTECTION

Hard hats are required on all job sites. Warning signs will be posted to caution of existing hazards whenever they are present. In some cases, debris nets may be used if a condition warrants additional protection. Additional overhead protection will include:

7. INJURED WORKER RESCUE (Emergencies and Injuries)

First Aid Trained Employee(s) On Site:

Name: _____ Title: _____ Level: _____

Name: _____ Title: _____ Level: _____

First Aid Kit Location(s): _____ Rescue Equipment Location(s): _____

Nearest Medical Facility: _____

Emergency Services Phone Numbers: _____

Location of Nearest Telephone: _____

Normal site specific first aid procedures should be followed and performed without delay. The signaling of rescue and/or first aid should be done immediately.

If the area is safe for entry, first aid should be initiated by the attendant, qualified person(s) or other certified individual.

Initiate Emergency Services – Dial 911 (where available)

Fall Protection

Competent and Qualified Person Designation Form

Safety Authority: **Sonic Drilling Ltd** Safety Department Program: Fall Protection

Contractor: _____ Supervisor: _____

Candidate's Name	Position	Supervisor Name
Division/Department	Contact phone	Alternate
Select One:	Competent Person	Qualified Person
Experience (include dates)		
Education and Training (include dates)		
Professional Certifications (if applicable)		

Person making this designation (print)	
Signature	
Designee Acceptance of Designation (sign)	
Date	

Job Hazard Analysis – Assessment and Control System

			Severity / Consequence				
			Insignificant <small>Injuries or ailments not requiring medical treatment.</small>	Minor <small>Medical help needed. Treatment by medical professional</small>	Moderate <small>Significant Serious injury Non-permanent injury.</small>	Major <small>Life threatening injury or multiple serious injuries causing hospitalization</small>	Catastrophic <small>Death or multiple life threatening injuries.</small>
			1	2	3	4	5
Likelihood	5	Almost certain to occur in most circumstances	6	7	8	9	10
	4	Likely to occur frequently	5	6	7	8	9
	3	Possible and likely to occur at some time	4	5	6	7	8
	2	Unlikely to occur but could happen	3	4	5	6	7
	1	May occur but only in rare and exceptional circumstances	2	3	4	5	6

How to Prioritise the Risk Rating

Once the level of risk has been determined the following table may be of use in determining when to act to institute the control measures.

Risk Priority		
Extreme (E) (>7 = Extreme Risk)	<p>Detailed action plan required. Act immediately to mitigate the risk. Either eliminate, substitute or implement engineering control measures. Work activities must be suspended immediately until hazard can be eliminated or controlled or reduced to a lower level.</p>	<p>Remove the hazard at the source. An identified extreme risk does not allow scope for the use of administrative controls or PPE , even in the short term.</p>
High (H) (6-7 = High risk)	<p>Needs senior management attention. Act immediately to mitigate the risk. Either eliminate, substitute or implement engineering control measures. If these controls are not immediately accessible, set a timeframe for their implementation and establish interim risk reduction strategies for the period of the set timeframe. Job hazards are unacceptable and must be controlled by engineering, administrative, or personal protective equipment methods as soon as possible.</p>	<p>An achievable timeframe must be established to ensure that elimination, substitution or engineering controls are implemented. NOTE: Risk (and not cost) must be the primary consideration in determining the timeframe. A timeframe of greater than 6 months would generally not be acceptable for any hazard identified as high risk.</p>
Medium (M) (5 = Med. risk)	<p>Specify management responsibility. Take reasonable steps to mitigate the risk. Until elimination, substitution or engineering controls can be implemented, institute administrative or personal protective equipment controls. These "lower level" controls must not be considered permanent solutions. The time for which they are established must be based on risk. At the end of the time, if the risk has not been addressed by elimination, substitution or engineering controls a further risk assessment must be undertaken.</p>	<p>Interim measures until permanent solutions can be implemented:</p> <ul style="list-style-type: none"> Develop administrative controls to limit the use or access. Provide supervision and specific training related to the issue of concern. <p>(See Administrative Controls below)</p>
Low (L) (<5 = Low risk)	<p>Manage by routine procedure. Take reasonable steps to mitigate and monitor the risk. Institute permanent controls in the long term. Permanent controls may be administrative in nature if the hazard has low frequency, rare likelihood and insignificant consequence. No real or significant hazard exists. Controls are not required but may increase the comfort level of employees.</p>	

Job Hazard Analysis – Assessment and Control System Cont...

Hierarchy of Control	Controls identified may be a mixture of the hierarchy in order to provide minimum operator exposure.
Elimination	Eliminate the hazard.
Substitution	Provide an alternative that is capable of performing the same task and is safer to use.
Engineering Controls	Provide or construct a physical barrier or guard.
Administrative Controls	Develop policies, procedures practices and guidelines, in consultation with employees, to mitigate the risk. Provide training, instruction and supervision about the hazard.
Personal Protective Equipment	Personal equipment designed to protect the individual from the hazard.

Take action on the assessment. Depending on the assigned Risk Level/Code (or Risk priority), take the corresponding action according to the table above:

- If Risk priority is LOW for a task step → requires monitoring.
- If Risk priority is MEDIUM → select and implement appropriate controls.
- If Risk priority is HIGH → Act immediately to mitigate the risk. Eliminate, substitute or implement measures.
- If Risk priority is EXTREMELY HIGH → immediately stop the task step until appropriate controls can be implemented.

A high risk priority means that there is a reasonable to high probability that an employee will be killed or permanently disabled doing this task step and/or a high probability that the employee will suffer severe illness or injury!

Select Action:

- Try to reduce employee exposure to the hazard by first implementing engineering, work practice, and/or administrative controls. Note the control method to be implemented in the far right column.

Certify the hazard assessment:

- Certify on the hazard assessment form that you have done the hazard assessment and implemented the needed controls.
- Incorporate any new requirements that you have developed into your written accident prevention program.

PERSONAL PROTECTIVE EQUIPMENT (PPE) PROGRAM

Statement of Purpose and Responsibilities (Part 8 and Part 7 of the OH&S Regulation)

It is the employer's responsibility to determine what protective equipment will be used for specific hazards. Supervisors are responsible for making equipment available and for its sanitation and maintenance. It is also the supervisor's responsibility to train each worker in its use and care, and to enforce regulations regarding its wearing or use. Where workers provide their own equipment, the supervisor shall be responsible for its adequacy including proper selection, maintenance, use, and sanitation of such equipment. A recommended policy is the "100 percent plan" under which all persons in designated hazardous areas (including supervisors and visitors) are required to wear all appropriate protective equipment.

Prior to using any type of Personal Protective Equipment, ensure it is in good shape, free of dirt and debris and that you are familiar with its correct use. Workers must ensure that all protective equipment fits properly and that it is free from damage. This will require that workers inspect their PPE prior to each use.

Personal protective equipment must always be stored with care to prevent damage. Refer to manufacturer's instructions for proper care and storage. The following points outline specific requirements for PPE;

SAFE WORK CLOTHING

Proper fit is important, since loose-fitting clothing may get caught in machine parts or on protruding objects. Shirts that are long-sleeved shall be worn whenever possible. Work pants and shirts should not have cuffs or pockets if worn near welding or cutting operations, since slag can get caught in them.

Fabrics such as cotton or wool should be selected for use around welding, torches, portable heaters, etc. Synthetics shall be avoided entirely since they may melt or burn rapidly if exposed to high heat. Clothing which is saturated by oil, fuel, or a flammable solvent can easily ignite and should not be worn.

Jewellery should not be worn on site. Rings, bracelets, wristwatches, and neck chains are dangerous near electrical equipment, machinery, jagged edges, and protruding objects.

Temperature Stresses

Heat, cold, and rain place stress on the body. These effects are compounded by heavy work. The combined effect of these stresses can lead to life-threatening situations such as the development of hypothermia (loss of body heat), heat exhaustion, and heat stroke. If necessary, workers shall be instructed in the proper attire for heat, cold, and rain.

HEAD PROTECTION (Part 8.11 of the OH&S Regulation)

- All workers shall wear, at all times on the job, a CSA approved safety hardhat.
- Workers must wear non-conductive safety headgear when exposed to electrical hazards.
- Never paint your hardhat and never wear a painted hardhat. The shell and suspension of hardhats must be inspected regularly for cracks, deep scratches or other defects.
- Replace a defective hardhat immediately.
- The replacement of headgear every 5 years and headgear suspension every year is highly recommended.

FOOT PROTECTION (Part 8.22 of the OH&S Regulation)

- At all times on the job, workers must wear CSA certified Grade 1 footwear. This footwear bears a green triangular patch stamped with the CSA trademark on the outside and rectangular green label on the inside.
- Safety footwear should always be worn with the laces tied up at the top of the footwear.
- Do Not wear safety footwear that is cracked or has cuts through the leather. Always make sure the footwear has good slip resistant sole material that is not excessively worn.

HAND PROTECTION (Part 8.19 of the OH&S Regulation)

In most cases, general duty gloves made from leather, cotton, and/or fabrics provide adequate protection against hand injuries. They allow considerable dexterity while shielding the hands from minor cuts, splinters, abrasions, and dirt. Some gloves provide a snug closure around the wrist, while other gloves extend protection to the forearm.

For work in wet areas, rubber or vinyl gloves are recommended. Insulated gloves and work-glove liners are available for cold weather work. Welding and cutting shall only be done with flame-resistant gauntlet gloves. In addition to gloves, many types of "sleeves" are available to protect the workers arms from cuts, scrapes, and burns as well.

SKIN PROTECTION (Part 8.19 to 8.21 of the OH&S Regulation)

- Workers are encouraged to always dress suitable for work. Items such as denim coveralls and cotton shirts provide protection against minor scrapes and bruises as well as harmful ultraviolet radiation.
- The following is the minimum recommended requirements for personal protection;
 - for personal safety on the job, Do Not wear loose clothing or cuffs, greasy or oily clothing, gloves or boots – torn or ragged clothing – finger rings.
 - Neck chains are hazardous and must be worn under clothing so that they don't hang out. Long hair must be tied back or otherwise confined.
 - Clothing made of synthetic fibers can be readily ignited and melted by electric flash. Cotton or wool fabrics are more flame retardant and are therefore recommended.
- Workers must at all times wear a shirt with a four inch sleeve in order to protect themselves from sunburn and abrasion.
- Long pants and long sleeved shirts are recommended for use to reduce minor cuts, scrapes and abrasions and should be worn when working with sharp or abrasive materials.
- Gloves should NOT BE WORN when operating powered tools such as drills, saws, table saws, etc.
- Workers should wear protective equipment when handling materials likely to puncture, abrade or irritate hands and arms, unless the use of this equipment introduces equal or greater hazards.

EYE PROTECTION (Part 8.14 – 8.18 of the OH&S Regulation)

The need for eye and face protection changes from moment to moment on the job site.

Certain activities, such as welding, cutting, using abrasive wheels or paving breakers, demand the use of specific protective devices. In other operations which may produce flying dust, sparks, or sprays, **Sonic Drilling Ltd** must determine the potential for preventable injury and establish requirements on that basis. **Sonic Drilling Ltd** shall make eye and face protection available and require their use by workers exposed to eye and face hazards.

Eye and face protective devices consist of safety glasses, goggles, face shields, welding goggles, and welding helmets. Safety glasses and goggles are designed to protect the eyes from dust, flying particles, sparks, and splashing liquids. Face shields provide additional protection from the same hazards and shall only be worn over safety glasses or goggles. Welding goggles and helmets must be used by all workers engaged in welding and by all workers assisting in these activities.

Eye and face protectors must provide adequate protection against the hazards for which they are used. The only protectors that may be used are those which conform to WCB regulations for impact resistance, heat deformation, flammability and durability.

These regulations are found in the Occupational Health and Safety Regulation, Section 8.14-8.18 EYE and FACE PROTECTION. Safety eyewear shall meet the requirement of CSA Standard CAN/CSA-Z94.3-92, Industrial Eye and Face Protectors or ANSI Standard Z87.1-1989, Practice for Occupational and Educational Eye and Face Protection.

Workers must ensure that their glasses, goggles and shields are kept clean and in good repair. Lenses and other clear pans shall be kept free from fog, pits or scratches. Lenses which are badly pitted, scratched or cracked or have lost some of their impact resistance, shall be replaced. Fogging can be reduced or eliminated by using special fog proof goggles or a fog-proof cleaning compound. Defective support pieces, such as frames, straps or helmets shall be replaced.

Eye protection must fit snugly and comfortably without interfering with the worker's movement or vision. Workers are more inclined to wear protective devices "full time" when they fit properly and comfortably.

Workers who wear prescription glasses must wear corrective lenses that conform to impact resistance requirements of ANSI Z-87, or CSA Standard CAN/CSA-Z94.3-92. They may wear goggles or welding helmets that fit over their prescription glasses. Contact lenses fail to provide any protection against dust or flying particles, therefore, safety goggles must be worn over contact lenses when hazards are present.

- Where the possibility of injury to the eyes exists, workers shall wear appropriate eye protection. As a basic requirement, workers are advised to always wear safety glasses with side shields.
- Workers must wear safety goggles over non-safety prescription glasses where an eye hazard exists.
- Workers engaged in the operation of sanders and grinders must wear safety glasses with side shields as well as face shields.
- Workers using chemical products, which may splash into the eyes shall wear safety goggles or chemical splash goggles dependent upon the requirements of the Material Safety Data Sheet for the product. The use of strong chemical products such as acids, base or alkaline products will require the use of a face shield as well as chemical goggles.
- Workers wearing contact lenses must inform their supervisor so that the lenses can be removed in the event of an accident.
- Workers must not wear contact lenses where gases, vapours, flying objects, dust or other materials are present that may harm the eyes or be absorbed by the lenses.

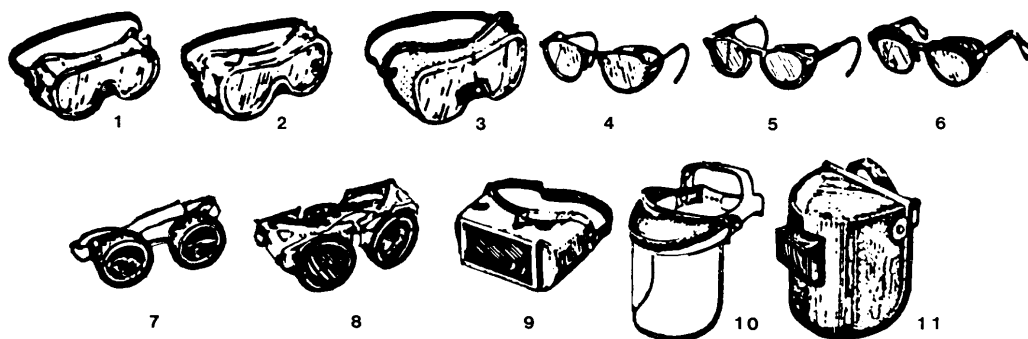

Types of Eye Protection

- | | |
|---|--|
| <ul style="list-style-type: none"> 1. GOGGLES, Flexible Fitting, Regular Ventilation 2. GOGGLES, Flexible Fitting, Hooded ventilation 3. GOGGLES, Cushioned Fitting, Rigid Body 4. SPECTACLES, Metal Frame, with Sideshields 5. SPECTACLES, Plastic Frame. with Sideshields 6. SPECTACLES , Metal-Plastic Frame. with Sideshields 7. WELDING GOGGLES, Eyecup Type, Tinted Lenses (Illustrated) | <ul style="list-style-type: none"> 7a. CHIPPING GOGGLES, Eyecup Type, Clear Safety Lenses (Not Illustrated) 8. WELDING GOGGLES, Coverspec Type, Tinted Lenses (Illustrated) 8b. CHIPPING GOGGLES, Coverspec Type, Clear Safety Lenses (Not Illustrated) 9. WELDING GOGGLES, Coverspec Type, Tinted Plate Lens 10. FACE SHIELD, (Available with Plastic or Mesh window) 11. WELDING HELMETS |
|---|--|

APPLICATIONS		
OPERATION	HAZARDS	RECOMMENDED PROTECTORS
ACETYLENE-BURNING ACETYLENE-CUTTING ACETYLENE-WELDING	SPARKS, HARMFUL RAYS, FLYING PARTICLES	7,8,9
CHEMICAL HANDLING	SPLASH, ACID BURNS, FUMES	2,10 (for severe exposure add 10 over 2)
CHIPPING	FLYING PARTICLES	1,3,4,5,6,7a,8a
ELECTRICAL (ARC) WELDING	SPARKS, INTENSE RAYS, MOLTEN METAL	9,11 (11 in combination with 4,5,6 in tinted lenses advisable)
FURNACE OPERATIONS	GLARE, HEAT, MOLTEN METAL	7,8,9 (for severe exposure add 10)
GRINDING-LIGHT	FLYING PARTICLES	1,3,4,5,6,10
GRINDING-HEAVY	FLYING PARTICLES	1,3,7a,8a (for severe exposure add 10)
LABORATORY	CHEMICAL SPLASH, GLASS BREAKAGE	2 (10 when in combination with 4,5,6)
MACHINING	FLYING PARTICLES	1,3,4,5,6,10
MOLTEN METALS	HEAT, GLARE, SPARKS, SPLASH	7,8 (10 in combination with 4,5,6 in tinted lenses)
SPOT WELDING	FLYING PARTICLES	1,3,4,5,6,10

HEARING PROTECTION (Part 7.7(1)(c)(d) of the OH&S Regulation)

Day to day exposure to loud noises can result in a permanent loss of hearing. An effective health and safety program takes positive steps to eliminate this problem. Damage to hearing occurs when a person is exposed to excessive noise levels.

Often, significant noise reduction is very difficult to attain. In those instances some form of personal protective equipment must be provided, such as ear muffs, disposable fiber or foam plugs, or reusable rubber plugs. Cotton provides little, if any, hearing protection and should not be part of any hearing conservation program.

Workers must be trained in the proper use and fitting of ear plugs, as the effectiveness of a plug depends primarily on how well it is fitted. Personal hygiene should be stressed, as dirt in the ear or on the plugs can lead to infection. It shall be pointed out to workers who use hearing protection equipment that while wearing the equipment, their hearing is somewhat reduced, and they may have difficulty hearing other workers backup alarms, and other important noises.

Audiograms should be part of the worker's pre-employment physical to determine if hearing loss is pre-existing. Annual audiograms will also allow the employer to verify the effectiveness of their hearing loss protection program.

The following points are the minimum standard to be achieved by trained workers;

- All workers engaged in Construction work are required to have an annual hearing test and are required to carry a current hearing test card.
- Workers engaged in activities, which generate noise, or who are exposed to noise from tools and equipment shall wear CSA approved hearing protection.
- Prolonged exposure to noise levels in excess of 90db is harmful. Examples of noise levels associated with the Construction Industry include;
 - Crane operator 82 – 99 db
 - Drilling 99 – 103 db
 - Welding 84 – 97 db
 - Air arc cutting 120 db
 - Pneumatic hammer 100 db
- Always keep your hearing protection clean to avoid irritation to the ear and ear canal.



RESPIRATORY PROTECTION (Part 8.32 to 8.45 of the OH&S Regulation)

The use of respirators is required whenever entering an area in which the concentration of airborne contaminants exceeds permissible exposure limit (PEL) standards. Supplied air breathing devices may also be necessary when workers enter areas deficient in oxygen. Exposure of workers to these hazardous atmospheres must be avoided whenever possible through engineering or administrative controls. Engineering controls, such as ventilation and spraying dusty areas with water, can often reduce the level of contaminants to the point where a respirator is no longer needed. Similarly, administrative controls, such as changing work procedures or schedules to eliminate exposure to hazardous atmospheres, shall be used whenever possible.

The use of a respirator does not necessarily ensure breathing clean air. It is essential that the proper respirator be selected, that it work consistently and properly, and that it is maintained, cleaned, and stored in the correct manner. For these reasons, each employer whose workers use respirators must develop a respiratory protection program. The program shall be administered by a suitably trained administrator and must include written operating procedures that provide direction for the selection, fitting, use, maintenance, and storage of respirators. The necessary components of an effective respiratory protection program shall include:

- Procedures for selecting respirators
- Medical evaluation of workers who use respirators
- Fit testing procedures for tight fitting respirator
- Procedures for proper use of respirators
- Procedures and schedules for maintaining respirators
- Procedures to ensure adequate air quality, quantity and flow of breathing air for supplied air respirators
- Training of workers in the respiratory hazards which they are potentially exposed
- Training of workers in the proper use of respirators
- Procedures for regularly evaluating the effectiveness of the respiratory protection program.



The use of respiratory equipment is only permitted by trained personal. Please refer to the Respiratory Protection Program for more information on the safe use of respirators.

The following points are the minimum standard to be achieved by trained workers;

- Construction workers are sometimes exposed to respiratory hazards generated by equipment, materials, or procedures. When this occurs, workers shall wear appropriate respiratory protection based on the hazard, the product, or the requirements of a Material Safety Data Sheet (MSDS).
- Respiratory protective devices range from disposable dust and vapour masks, through twin cartridge half mask respirators, to air supplied respirators and Self Contained Breathing Apparatus (SCBA).
- Workers required to wear respirators must be clean shaven in the areas where the respirator contacts the skin.
- Only workers who have been adequately instructed shall wear respirators. Half mask, full mask and air supplied respirators require that the wearer be fit tested to the respirator to be worn.
- No worker shall use these types of respirator until they have been successfully fit tested. Workers shall only use the respirator they were fit tested to unless a new fit test is performed, shall not use a substitute respirator.
- Respirators, other than disposable types, shall be stored in a clean, dry area, preferably in a plastic bag. Damaged respirators shall not be used until they are repaired or replaced.

MACHINE AND TOOL GUARDS (Part 12.2(b),(c) of the OH&S Regulation)

Employees, who are responsible for placing equipment into service, are also responsible to ensure that equipment guards are in place. If, due to damage or deterioration, the original guard provided on a piece of equipment cannot be put in place, employees should use a temporary method, offering equal or better protection than that required by the manufacturer and OH&S.

Some examples of tools requiring guards are;

- Table saws
- Circular saws.
- Grinders.
- Compressors where the pump and the compressor are connected via a belt.

All tools which have a guard on them by design must ensure that guard is in place and that it is working effectively. Under no circumstances is a worker permitted to remove a guard from a tool unless it is to affix another piece of equipment. For example a shroud assembly is required when attaching a vacuum to a grinder for the purposes of finishing cement. In this case the guard must be removed in order to attach the shroud.



Sonic Drilling Ltd.

Respiratory Protection Program



RESPIRATORY PROTECTION PROGRAM

PURPOSE

The purpose of this respirator program is to establish standard operating procedures to ensure the protection of all employees from respiratory hazards through proper selection and use of respirators. This program applies to all employees who are required to wear respirators during normal operations, non-routine tasks, or emergency operations such as a spill of a hazardous substance.

RESPONSIBILITIES

Program Administrator Duties

Sonic Drilling Ltd has designated _____ as the program administrator to oversee the respiratory protection program.

Duties of the program administrator include:

- Identifying work areas, processes or tasks that require workers to wear respirators, and evaluating hazards
- Selection of respiratory protection options
- Monitoring respirator use to ensure that respirators are used in accordance with their certifications
- Arranging for and/or conduct training
- Ensuring proper storage and maintenance of respiratory protection equipment
- Conducting or arranging for fit testing
- Administering the medical surveillance program
- Maintaining records required by the program
- Evaluating the program
- Updating written program as needed

Supervisors Duties

Supervisors are responsible for ensuring that the respiratory protection program is implemented in their particular areas. In addition to being knowledgeable about the program requirements for their own protection, supervisors must also ensure that the program is understood and followed by the employees under their charge.

Duties of the supervisor include:

- Ensuring that employees under their supervision (including new hires) have received appropriate training, fit testing, and medical evaluation
- Ensuring the availability of appropriate respirators and accessories
- Being aware of tasks requiring the use of respiratory protection
- Enforcing the proper use of respiratory protection when necessary
- Ensuring that respirators are properly cleaned, maintained, and stored according to the respiratory protection plan
- Ensuring that respirators fit well and do not cause discomfort
- Continually monitoring work areas and operations to identify respiratory hazards
- Coordinating with the program administrator on how to address respiratory hazards or other concerns regarding the program

Employees Duties

Each employee has the responsibility to wear his or her respirator when and where required and in the manner in which they were trained. Employees must also:

- Care for and maintain their respirators as instructed and store them in a clean sanitary location
- Inform their supervisor if the respirator no longer fits well, and request a new one that fits properly
- Inform their supervisor or the Program administrator of any respiratory hazards that they feel may not be adequately addressed in the workplace and of any other concerns that they have regarding the program

PROGRAM ELEMENTS

Hazard Identification, Assessment and Control

A written hazard assessment must be completed, communicated and understood by all individuals involved in the work area. The written hazard assessment is important to determine if respiratory protection is needed and the selection of the correct type.

In order to determine the presence of a respiratory hazard and to assist in selection of an appropriate respirator, a hazard assessment of the work area shall be conducted by the supervisor. The hazard assessment of a respiratory hazard includes the following:

- Identification of contaminants (chemical, biological) that may be present in the workplace;
- Identification of physical states of all airborne contaminants;
- Determination of the likelihood of inhalation of the contaminants;
- Measurement or estimation of the concentration of the contaminants;
- Determination of oxygen level (potential oxygen deficiency);
- Identification of appropriate occupational exposure limit for each airborne contaminant;
- Determination of whether the atmosphere is immediately dangerous to life and health (IDLH);
- Determination of existence of adequate warning properties;
- Determination of skin or eye absorption and irritation characteristics.

In instances where exposure cannot be identified or reasonably estimated, the atmosphere shall be considered IDLH.

The hierarchy of controls will dictate the controls needed to minimize the hazard. Engineering controls are the preferred control method to eliminate or minimize the risk of airborne hazards. Personal Protective Equipment (PPE), like respiratory protection, is normally the last resort in minimizing the hazards of airborne contaminants.

Airborne Hazards

Respiratory hazards may include airborne contaminants such as dusts, mists, fumes, and gases, or oxygen-deficient atmospheres. While there are many non-occupational sources of airborne contaminants, there are also many materials that become airborne in an occupational setting. Inhalation is generally viewed as the most significant route of entry for toxic materials in most workplaces. The specific airborne hazards that workers are exposed to will vary and depend upon their occupation.

Airborne hazardous materials can be separated into 4 different classifications:

- Particulates/aerosols (solid particles, dusts, fibres, mists, droplets, fumes)
- Gases and/or vapours (gaseous contaminants, vapours)
- Oxygen-deficient atmospheres (containing less than 19.5 % oxygen).
- Combination (any combination of particulates, gases, and/or vapours, including oxygen deficient atmospheres)

Hazard Assessment and Control

Hazard assessment is a formal process for identifying all existing and potential hazards at a work site and then determining the degree of danger (the risk) the hazards pose to workers.

Hazards can be classified into the following categories:

- Physical hazards – lifting, slipping & tripping, fire electricity, noise working at heights, moving parts of machinery etc.
- Chemical hazards – solvents, acids, cleaners etc.
- Biological hazards – tissues, bacteria, blood and body fluids etc.

All categories should be considered for inclusion in the hazard assessment. Once workplace hazards have been identified and rated, hazard controls must be put in place to reduce the risk workers face from exposures to the hazards. In general terms there are three types of control available to reduce the risk due to exposure to hazards and they are listed here in the appropriate hierarchy:

- ***First: Engineering Controls***
- ***Second: Administrative Controls***
- ***Third: Personal Protective Equipment (PPE)***

Sometimes a hazard cannot be adequately controlled by a single type of control (engineering, administrative or PPE). A combination of these methods may be required to effectively control the hazard.

Engineering Control Methods

Engineering control measures remove or reduce the hazard by initial engineering design specifications or by applying methods of substitution, isolation or ventilation. Well designed and maintained engineering controls are the preferred methods of controlling worker exposure to hazardous contaminants in the air.

Engineering control methods include:

- Mechanical ventilation;
- Adding clean air to oxygen-deficient space;
- Enclosure or Isolation of the process or work equipment;
- Proper control and use of process equipment; and
- Process modifications including substitution with less hazardous materials where possible.

Administrative Control Methods

Administrative controls may be used in addition to engineering controls. Administrative control methods minimize worker exposure by scheduling reduced work times in contaminant areas, good work practices and worker training. Appropriate training includes hazard recognition and work practices specific to the worker's job that can assist in reducing exposures. These control measures have many limitations since the hazard is not eliminated or removed. Administrative controls are not generally favored because they can be difficult to implement, maintain, and are not reliable.

Personal Protective Equipment

Protective equipment may only be used where airborne hazards cannot be eliminated or sufficiently reduced with engineering or administrative controls. Respirators are the least satisfactory means of exposure control because they only provide good protection if they are properly selected, fit tested, worn by the workers, and replaced when their service life is over. In addition, some workers may not be able to wear a respirator due to health or physical limitations. Respirators can also be cumbersome to use and hot to wear, and they may reduce vision and interfere with communication.

Despite these difficulties, respirators are the only form of protection available in the following situations:

- During the installation or implementation of feasible engineering and work practice controls.
- In work operations, such as maintenance and repair activities for which engineering and work practice controls are not yet sufficient to reduce exposure to or below the Occupational Exposure Limit (OEL).
- In emergencies.

Personal protective equipment can be used in conjunction with engineering controls and other methods of control to minimize potential exposures.

Every worker in an area with airborne contaminants that are or may potentially be over 50% of the Occupational Exposure Limit must wear appropriate personal protective equipment. Workers must use:

- Appropriate respiratory protective equipment
- Protective clothing (laboratory coats, Tyvek suits etc) to reduce the risk of contaminating street clothing, skin and hair; and
- Other protective equipment such as eye protection, hard hats, hearing protection and steel toe footwear as site conditions, regulations, or the hazard assessment requires.

The supervisor must ensure that personal protective equipment provided to workers will not cause medical problems (e.g. latex allergies, breathing difficulties).

Types of Respiratory Protective Equipment

Respiratory protective devices can be described based on their capabilities and limitations and places in three classes:

- Self-Contained Breathing Apparatus (SCBA)
- Air-Supplying Respirators
- Air-Purifying Respirators

Self-Contained Breathing Apparatus (SCBA)

The self-contained breathing apparatus (SCBA) provides respiratory protection against gases, vapours, particles, and an oxygen deficient atmosphere.

The wearer is independent of the surrounding atmosphere because the breathing gas is carried by the wearer. SCBA may be used in IDLH (immediately dangerous to life and health) situations and oxygen-deficient atmospheres either as escape-only devices or for entry into and escape from these atmospheres.

There are two major types of SCBAs:

- Closed-Circuit SCBA
- Open-Circuit SCBA

Closed-Circuit SCBA

In a closed-circuit SCBA, all or a percentage of the exhaled gas is scrubbed and re-breathed. Closed-circuit SCBAs are designed to provide 30 minutes to 4 hours of service.

Open-Circuit SCBA

In an open-circuit SCBA, the exhaled breath is released to the surrounding environment rather than being recirculated. The breathing gas is generally compressed breathing air. Typically they are designed to provide 30-60 minutes of service. Only full-face piece, pressure demand (positive pressure) SCBAs are approved for immediately dangerous to life and health (IDLH) atmospheres.

Escape SCBA

Some SCBAs are designed for escape only and are similar in design to the closed-circuit and open-circuit SCBA types. Their time of use tends to be shorter, typically 5, 7, or 10 minutes. Escape-only units CAN NOT be used to enter into a hazardous atmosphere.

Air-Supplying Type

Air-supplying types of respirators provide a respirable atmosphere to the wearer, independent of the ambient air. The breathing source is supplied from an uncontaminated source through a hose connected to the wearer's face piece or head enclosure from a compressor or compressed air cylinders. These devices may only be used in non-IDLH atmospheres or atmospheres in which the wearer can escape without the use of a respirator. If the air supply fails, the wearer may have to remove the respirator to escape from the area.

In IDLH and oxygen deficient atmospheres, a combination SCBA and air-line respirator may be used since the auxiliary SCBA can be switched to in the event the primary air supply fails to operate and allows the wearer to escape from the IDLH atmosphere.

Air-Purifying Respirators

Air-purifying devices clean the contaminated atmosphere. Ambient air passes through an air-purifying element (by filtration or absorption) that can remove specific gases and vapours, aerosols, or a combination of these contaminants. This type of device is limited in its use to those environments where there is sufficient oxygen and the contaminant's airborne concentration level is within the maximum use concentration of the device. The useful life of an air-purifying device is limited by the concentration of the air contaminants, the breathing rate of the wearer, temperature and humidity levels in the workplace, and the removal capacity of the air-purifying medium.

Air-purifying respirators can be of three types:

- Aerosol (Particle) Removing Respirator
- Gas/Vapor Removing Respirator
- Combination Aerosol Filter/Gas or Vapour-Removing Respirator

Air-purifying respirators cannot be used in IDLH environments because there are limits to the amount of contaminants they can remove. Air-purifying respirators are not appropriate for use in oxygen-deficient atmospheres since they do not supply oxygen and may only be used when the ambient atmosphere contains at least 19.5% oxygen.

Air-purifying respirators are not appropriate for use as protection against materials with poor warning properties (substances that cannot be detected by the respirator wearer by smell, taste or feel) since concentrations inside the respirator may unknowingly reach unsafe levels. The detection of contaminants inside a respirator is called breakthrough.

There are some exceptions to this rule; asbestos, silica and radioactive particles are both potential carcinogens with no warning properties but for which the use of air-purifying respirators are adequate up to certain concentrations.

Half Face Respirators

Half face respirators fit under the chin to the bridge of the nose. They are more comfortable in some situations, but may be more difficult in terms of fitting well around a worker's nose, chin and cheeks. Air is drawn through the cartridge or filter by negative pressure that is created inside the respirator face piece when the user inhales.

Full-Face Respirators

Full-face respirators provide a higher level of protection and a better fit than half-face respirators. Full face respirators fit over the entire face, from the hairline to under the chin, and offer eye protection. Air is drawn through the cartridge or filter by negative pressure that is created inside the respirator face piece when the user inhales.

Dust Masks

Dust masks are disposable half face particulate filter respirators. They are also known as a filtering face piece respirator commonly used in health care and construction/renovation applications. Air is drawn through the filter by negative pressure that is created inside the dust mask when the user inhales.

Powered Air-Purifying Respirators

Powered air-purifying respirators (PAPR) are a variation on air-purifying respirators. A PAPR utilizes a battery-powered blower that draws the contaminated air through the cartridge or filter. The cleaned air is then forced through a hose to the face piece which may be tight-fitting or a helmet or a hood that does not seal tightly against the face of the wearer. PAPRs supply purified air at a positive pressure, which means if a leak occurs in the face piece, helmet, or hood, air should move outward. PAPRs provide the same level of protection as a negative-pressure air-purifying respirator.

Respirator Selection

The employer, in consultation with the worker and the occupational health and safety committee, if any, or the worker health and safety representative, if any, must select appropriate respiratory protective equipment in accordance with *CSA Standard CAN/CSA-Z94.4-93, Selection, Use, and Care of Respirators*.

Only respiratory protective equipment which meets the requirements of a standard acceptable to WorkSafeBC may be used for protection against airborne contaminants in the workplace. The Program Administrator will conduct a hazard evaluation for each operation process, or work area where airborne contaminants may be present in routine operations or during an emergency. ***The hazard evaluation will include:***

- Identification of the hazardous substances used in the workplace, department or work process;
- Review of work processes to determine where potential exposures to these hazardous substances may occur; and
- Exposure monitoring to quantify potential hazardous exposures.

The results of the hazard evaluation are located _____
(Insert location/department) for employee review.

The program administrator will revise and update the hazard assessment as needed (i.e., any time work process changes which may potentially affect exposure).

General requirements

- The employer shall select and provide an appropriate respirator based on the respiratory hazard(s) to which the worker is exposed and workplace and user factors that affect respirator performance and reliability.
- The respirator shall be used in compliance with the conditions of its certification.
- The employer shall identify and evaluate the respiratory hazard(s) in the workplace; this evaluation shall include a reasonable estimate of employee exposures to respiratory hazard(s) and an identification of the contaminant's chemical state and physical form. Where the employer cannot identify or reasonably estimate the employee exposure, the employer shall consider the atmosphere to be IDLH.
- The employer shall select respirators from a sufficient number of respirator models and sizes so that the respirator is acceptable to, and correctly fits, the user.

How to Select the Correct Respirator

The type and brands of respirators vary widely ranging from simple dust masks to supplied air respirators like the kind firemen wear.

The following is description of the main types of respirators.



Dust Masks (filtering face pieces)

These simple, two-strap disposable dust masks are designed only for dusts. They are not as protective as other respirators, but do an adequate job in many cases, unless the dust is really toxic or copious. Don't confuse these two-strap masks with the less protective one-strap dust mask designed only for pollen or non-toxic dust.



Half-Face Air-Purifying Respirator

These respirators are sometimes called “half-face” or “half-mask” respirators since they cover just the nose and mouth. They have removable cartridges that filter out either dust, chemicals or both. Selecting the correct cartridges is essential since they are designed for particular types of chemicals or dust.

A reputable respirator vendor can assist you in selecting the correct cartridges. These cartridges are typically removable and sometimes interchangeable.

Cartridges are available for solvents, ammonia, chlorine, acids and other chemicals. The cartridges must be changed out or replaced periodically, especially for chemicals, since they can absorb only so much contaminant before breakthrough occurs.

A few cartridges are equipped with end-of-service indicators that show when a cartridge should be replaced. Most cartridges don't have this indicator and you must develop a change-out schedule to prevent breakthrough. The change-out schedule is based on the chemical concentration, physical work effort, temperature and humidity. Many respirator manufacturers have cartridge change schedule calculators available on the Internet.



Full-Face Air-Purifying Respirator

In some situations, you may need or want to use full-face respirators. This type of respirator is used when the air contaminant irritates the eyes. They also provide somewhat higher protection to the lungs since they tend to fit tighter and are less prone to leaking. These respirators also have replaceable cartridges that must be changed on a regular basis as described above for half-face respirators.



Powered Air Purifying Respirator (PAPR)

Powered Air Purifying Respirators have a battery pack that draws air through replaceable cartridges and blows into a full face piece, helmet or hood.

These respirators are often more comfortable in hot weather and some can provide more protection, depending on the type. The cartridges must be changed regularly as describe for half-face respirators above.



Airline Respirator



Tank-type respirator (SCBA)

Supplied Air Respirators and Self-Contained Breathing Apparatus (SCBA)

In a few situations, you may need to provide a supplied air respirator to your employees. These situations include large chemical spills or leaks, entering a confined space where there is lack of oxygen or high levels of air contaminants, or working around extremely toxic chemicals.

They may also be necessary working at hazardous waste sites, during sandblasting or in some spray painting operations. "Supplied air," means that clean air is provided by means of an air hose from a compressor or a pressurized air tank.

Supplied air respirators are required when a respiratory hazard is considered "immediately dangerous to life or health" (also called "IDLH"). Respiratory hazards are classified as IDLH as follows:

- There is a lack of oxygen (less than 19.5% oxygen)
- There is too much oxygen (more than 23.5% - a fire hazard)
- You know there are toxic chemicals in the air, but you don't know how much
- The amount of chemical in the air is known or expected to be above the IDLH level for that chemical.

Levels of chemicals above IDLH can occur in confined spaces, or enclosed spaces where there is little or no ventilation.

Respirators for Immediately Dangerous to Life and Health (IDLH) atmospheres

1. If a worker is required to enter or work in an IDLH or oxygen deficient atmosphere the worker must
 - a. wear a full face piece positive pressure respirator which is either an SCBA, or an airline respirator with an auxiliary self- contained air cylinder of sufficient capacity to permit the worker to escape unassisted from the contaminated area if the air supply fails, and
 - b. be attended by at least one other worker stationed at or near the entrance to the contaminated area who is similarly equipped and capable of effecting rescue.
2. Subsection (1)(a) applies if there is a significant risk of accidental release into a worker's breathing zone of quantities of an air contaminant sufficient to produce an IDLH atmosphere.

Respirators for atmospheres that are not IDLH

- The employer shall provide a respirator that is adequate to protect the health of the employee and ensure compliance with all other statutory and regulatory requirements, under routine and reasonably foreseeable emergency situations.

Medical Evaluation

If a worker is required to use a respirator and there is doubt about the worker's ability to use a respirator for medical reasons, the worker must be examined by a physician, and the examining physician must be provided with sufficient information to allow the physician to advise the employer of the ability of the worker to wear a respirator.

A licensed health care professional at _____
(Name of healthcare provider) will provide the medical evaluation to employees.
Medical evaluation procedures are as follows:

NOTE: All examinations and questionnaires are to remain confidential between the employee and the physician.

Protection factors

A respirator must not be used for protection against concentrations of an air contaminant greater than the maximum use concentration, which is the concentration determined by multiplying the exposure limit for the air contaminant by the appropriate respirator protection factor selected from Table 1, or as otherwise determined by WorkSafeBC.

Table 1 - Respirator protection factors

Respirator type	Protection Factor
Air purifying	
Half face piece, non-powered	10
Full face piece, non-powered	50
Full face piece, powered (PAPR), equipped with HEPA filters for exposure to asbestos	100
Full face piece, powered (PAPR), equipped with HEPA filters and/or sorbent cartridge or canister for exposure to contaminants other than asbestos	1 000
Loose-fitting face piece, powered (PAPR)	25
Air supplying	
Airline - demand (negative pressure)	
Half face piece	10
Full face piece	50
Airline - continuous flow	
Loose-fitting face piece/hoods	25
Half face piece	50
Full face piece	1 000
Helmet/hood	1 000
Airline - pressure demand (positive pressure)	
Half face piece	50
Full face piece	1 000
Full face piece, with egress bottle	10 000
Self-contained breathing apparatus (SCBA)	
Demand (negative pressure)	50
Pressure demand (positive pressure)	10 000
Other factors such as warning properties, IDLH levels, and cartridge/canister limitations must also be taken into account when determining the maximum use concentration. Refer to the manufacturer's instructions and standards acceptable to the Board for further information.	

Fit tests

A respirator which requires an effective seal with the face for proper functioning must not be issued to a worker unless a fit test demonstrates that the face piece forms an effective seal with the wearer's face.

Fit tests must be performed in accordance with procedures in *CSA Standard CAN/CSA-Z94.4-02, Selection, Use, and Care of Respirators*.

_____ **Sonic Drilling Ltd** requires employees to be fit tested at the following times and with the same make, model, style, and size of respirator that they will be using and...

A fit test must be carried out...

- (a) before initial use of a respirator,
- (b) at least once a year,
- (c) whenever there is a change in respirator face piece, brand, model, and size, and
- (d) whenever changes to the user's physical condition could affect the respirator fit.

Note: Other personal protective equipment that is to be worn at the same time as a respirator and which could interfere with the respirator fit must be worn during a fit test.

Fit Testing Procedures - Please refer to Respiratory Fit Test Instructions and User Record

_____ (***Name of responsible person or department***) will ensure that fit-test(s) will be administered by qualified person(s) only.

The company has established a record of the fit tests administered to employees including:

- The name or identification of the employee tested;
- Type of fit test performed;
- Specific make, model, style, and size of respirator tested;
- Date of test; and
- The pass/fail results

Use of Respirators

General Use Procedures

Employees will use their respirators under conditions specified by this program, and in accordance with the training they receive on the use of each particular model.



In addition, the respirator shall not be used in a manner for which it is not certified.

Face seal

Except for specialty eyewear approved by WorkSafeBC for use with positive pressure full face piece respirators, nothing is permitted which intrudes between the face piece and the face, or which interferes with the face seal of the face piece.



A worker required to wear a respirator which requires an effective seal with the face for proper functioning must be clean shaven where the respirator seals with the face.

All employees shall be permitted to leave the work area to maintain their respirator for the following reasons: to clean their respirator if the respirator is impeding their ability to work, change filters or cartridges, replace parts, or to inspect respirator if it stops functioning as intended. Employees should notify their supervisor before leaving the area.

Employees are not permitted to wear tight fitting respirators if they have any condition, such as facial hair, facial scars, or missing dentures that prevents them from achieving a good seal. Employees are not permitted to wear headphones, jewelry, or other articles that may interfere with the facepiece to face seal.

Voluntary Respirator Usage

In circumstances where **section 8.32** of the WCB regulation does not apply, and either an employer chooses to provide a respirator to a worker or the worker chooses to use a personal respirator, then the requirements of **sections 8.3, 8.7 and 8.33(2)** apply.

This company will provide (or allow employee-owned) respirators to employees for voluntary usage for the following work processes:

The Program Administrator shall authorize voluntary use of respiratory protective equipment as requested by all other workers on a case-by-case basis, depending on specific workplace conditions and the results of the medical evaluations.

Emergency Procedures

The following work areas have been identified as having foreseeable emergencies:
(FILL IN AS REQUIRED)

- _____
- _____
- _____

Emergency escape respirators are located: _____ **(Insert Location)**.

Immediately Dangerous to Life or Health (IDLH) Procedures

The Program Administrator has identified the following area(s) as presenting the potential for IDLH conditions: **(FILL IN AS REQUIRED)**

- _____
- _____
- _____

Respirator Malfunction

For any malfunction of a respirator (e.g., such a breakthrough, facepiece leakage, or improperly working valve), the respirator wearer should inform his or her supervisor that the respirator no longer functions as intended, and go to a safe area to maintain the respirator. The supervisor must ensure that the employee receives the needed parts to repair the respirator, or is provided with a new respirator.

Emergency escape respirators

If the nature or quantity of an air contaminant and the nature of the work area could prevent a worker escaping from a contaminated area without assistance, the worker must carry an emergency escape respirator.

The emergency escape respirator must be

- (a) carried on the worker's person or be within arm's reach at all times, and
- (b) sufficient to permit the worker to leave the contaminated area without assistance.



Emergency Escape Respirators

Emergency escape respirators, as the name implies, can only be used for one thing – to escape or exit from a room or building in an emergency, usually a large chemical release, leak or spill, or when a supplied air respirator fails or runs out of air.

An escape respirator is typically a small bottle or tank of air connected to a face piece that supplies 5-10 minutes of air. Some supplied air respirators will have an auxiliary bottle of air for escape that connects to the existing face piece.

How do you decide which type of respirator to select? First, it must be the correct type for the air contaminant. Second, it must fit properly. Third, it must provide adequate protection for the amount of chemical in the air. The more toxic or more concentrated the chemical is in the air, the higher the level of protection the respirator must provide.

Different respirators provide different protection. Depending on the amount of chemical in the air, you may need to use a respirator that provides more protection. Respirators are rated by their “assigned protection factor” (APF) which is a number between 10 and 10,000. The higher the number, the greater the protection.

A respirator with a protection factor of 10 will provide adequate protection to levels of the chemical in the air 10 times the safe limit of that chemical.

Table 1 - Respirator protection factors for further details.

**Table 2 below provides selection information regarding air-purifying respirators
for
Particle, Vapor, or Gas contaminants.**

Table 2 Selecting Air-purifying Respirators	
If the contaminant is a:	Then
<p>Gas or vapor</p> 	<p>Provide a respirator with canisters or cartridges equipped with a NIOSH-certified, end-of-service-life indicator (ESLI) <i>(note: there just a few of these)</i></p> <p>or</p> <p>If a canister or cartridge with an ESLI is not available, develop a cartridge change schedule to make sure the canisters or cartridges are replaced before they are no longer effective <i>(note: most cartridge respirators fit in this category)</i></p> <p>or</p> <p>Select an air-supplying respirator</p>
<p>Particle, such as a dust, spray, mist, fog, fume, or aerosol</p> 	<p>Select respirators with filters certified to be at least 95% efficient by NIOSH. For example, N95s, R99s, P100s, or High Efficiency Particulate Air filters (HEPA)</p> <p>Or</p> <p>You may select respirators NIOSH certified as “dust and mist,” “dust, fume, or mist,” or “pesticides.” You can only use these respirators if particles primarily have a mass median aerodynamic diameter of at least 2 micrometers <i>Note: These latter respirators are no longer sold for occupational use, but some employers may still be using them.</i></p>

Maintenance and Care Procedures

Inspection of compressed air cylinders must be done in accordance with CSA Standard CAN/CSA-Z94.4-02, Selection, Use, and Care of Respirators.

Self-contained breathing apparatus, including regulators, must be serviced and repaired by qualified persons.

Compressed air cylinders must be hydrostatically tested in accordance with CSA Standard CAN/CSA-B339-96, Cylinders, Spheres, and Tubes for the Transportation of Dangerous Goods.

In order to ensure continuing protection from the respirators being use, it is necessary to establish and implement proper maintenance and care procedures and schedules. A lax attitude toward maintenance and care will negate successful selection and fit because the devices will not deliver the assumed protection unless they are kept in good working order.

Cleaning & Disinfecting

Our company provides each respirator user with a respirator that is clean, sanitary, and in good working order. We ensure that respirators are cleaned and disinfected _____ (***Indicate Frequency, e.g., Daily, Weekly, etc.***) or as often as necessary to be maintained in a sanitary condition. Respirators are cleaned and disinfected using the procedures specified in Appendix B-2 of the standard or manufacturer's recommendations.

Respirators are cleaned and disinfected:

- As often as necessary when issued for the exclusive use of one employee;
- Before being worn by different individuals;
- After each use for emergency use respirators; and
- After each use for respirators used for fit testing and training.

Storage

Storage of respirators must be done properly to ensure that the equipment is protected and not subject to environmental conditions that may cause deterioration. We ensure that respirators are stored to protect them from damage, contamination, dust, sunlight, extreme temperatures, excessive moisture,, and damaging chemicals. They are packed and stored in _____ (**Indicate methods use for storage and location**), in accordance with any applicable manufacturer's instructions.

Emergency respirators are stored:

- To be accessible to the work area;
- In compartments marked as such; and
- In accordance with manufacturer's recommendations.

Respirator Inspection

All respirators will be inspected after each use and at least monthly. Should any defects be noted, the respirators will be taken to the program administrator or supervisor. Damaged respirators will be either repaired or replaced.

Respirators shall be inspected as follows:

- All respirators used in routine situations shall be inspected before each use and during cleaning;
- All respirators maintained for use in emergency situations shall be inspected at least monthly and in accordance with manufacturer's recommendations, and shall be checked for proper function before and after each use; and
- Emergency escape-only respirators shall be inspected before being carried into the workplace for use.

Respirator inspections shall include the following:

- A check of respirator function, tightness of connections, and the condition of the various parts including, but not limited to, the facepiece, head straps, valves, connecting tube, and cartridges, canisters or filters; and
- Check of elastomeric parts for pliability and signs of deterioration.

The following checklist will be used when inspecting respirators:

1. Facepiece:

- cracks, tears, or holes
- facemask distortion
- cracked or loose lenses/faceshield

2. Headstraps:

- breaks or tears
- broken buckles

3. Valves:

- residue or dirt
- cracks or tears in valve material

4. Filters/Cartridges:

- approval designation
- gaskets
- cracks or dents in housing
- proper cartridge for hazard

5. Air Supply Systems:

- breathing air quality/grade
- condition of supply hoses
- hose connections
- settings on regulators and valves

Training

_____ **(Name of responsible person or department)** will be responsible to provide training to respirator users or their supervisors on the contents of the Respiratory Protection Program and their responsibilities under it.

Workers will be trained prior to using a respirator in the workplace. Supervisors will also be trained prior to using a respirator in the workplace or prior to supervision of employees that must wear respirators.

The training will cover the following topics:

- ***Sonic Drilling Ltd*** Respiratory Protection Program
- Respiratory hazards encountered and their health effects
- Proper selection and use of respirators
- Limitations of respirators
- Respirator donning and user seal (fit) checks
- Fit testing
- Emergency use procedures
- Maintenance and storage
- Medical signs and symptoms limiting the effective use of respirators

Employees will be retrained annually or as needed (e.g., if they need to use a different respirator). Employees must demonstrate their understanding of the topics covered in the training utilizing a hands-on exercise and a written test. Respirator training will be documented by the Program Administrator and the documentation will include the type, model, and size of respirator for which each employee has been trained and fit tested.

Program Evaluation

The program administrator will conduct periodic evaluations of the workplace to ensure that the provisions of this program are being implemented. The evaluation will include regular consultations with employees who use respirators and their supervisors, site inspections, air monitoring and review of records.

Identified problems will be noted and addressed by the Program Administrator. These findings will be reported to management, and the report will list plans to correct deficiencies in the respirator program and target dates for the implementations of those corrections.

Documentation and Recordkeeping

As per **WCB regulation 8.44**, The employer must maintain a record of;

- (a) fit test results and worker instruction,
- (b) maintenance for air supplying respirators, powered air purifying respirators, and for sorbent cartridges and canisters, and
- (c) maintenance and repairs for each self-contained breathing apparatus and all air cylinders in accordance with the requirements of *CSA Standard CAN/CSA-Z94.4-02, Selection, Use, and Care of Respirators*.

A written copy of this program is part of the company Occupational Health & Safety Program and is available to all employees who wish to review it.

Also maintained are copies of training and fit test records. These records will be updated as new employees are trained, as existing employees receive refresher training, and as new fit tests are conducted.

The Program Administrator will also maintain copies of the medical records for all employees covered under the respirator program. The completed physician's documents and recommendations are confidential and will remain at _____ (**Location, e.g., clinic**).

The company will only retain the physician's written recommendation regarding each employee's ability to wear a respirator.

Respirator Fit-Test Instructions

NEGATIVE AND POSITIVE FIT CHECKS:

Fit-checking and testing is done to find both a style and a size of respirator that fits the individual best and most comfortable. Before an irritant smoke or banana oil test is carried out, a positive and negative pressure fit-check is required. These checks will give the individual a general indication that the respirator provides a seal.

Once a seal is obtained, then a smoke or banana oil test must be done.

The pressure fit-checks are also done each time the individual puts on a respirator to make sure there is a proper seal.

NOTE: SOME RESPIRATOR FILTERS OR CARTRIDGES MAY BE TOO LARGE TO SEAL OFF WITH THE PALM OF THE HAND. THIS MEANS A NEGATIVE PRESSURE FIT-CHECK CANNOT BE DONE. IF THIS IS THE CASE, DO A POSITIVE PRESSURE FIT-CHECK.

Fit Check Procedure

Close off the inlet to the filter or cartridge by lightly pressing the palms against it, or by squeezing or covering the breathing tube (on an air line respirator or full-face respirator gas mask).

Inhale gently to build a slight negative pressure in the respirator. Hold for ten (10) seconds. If the face piece remains slightly collapsed and no inward leakage is detected, the respirator is probably sealed properly.

If leakage does occur adjust straps or adjust the face piece and try again.

For a positive pressure fit check cover the exhalation valve, or the end the breathing tube on an airline respirator or full face respirator. Gently blow out and hold for ten (10) seconds.

The fit-check is satisfactory if there is no outward leakage.

During both tests, care should be taken that the respirator is not distorted (too firm a pressure will do this).

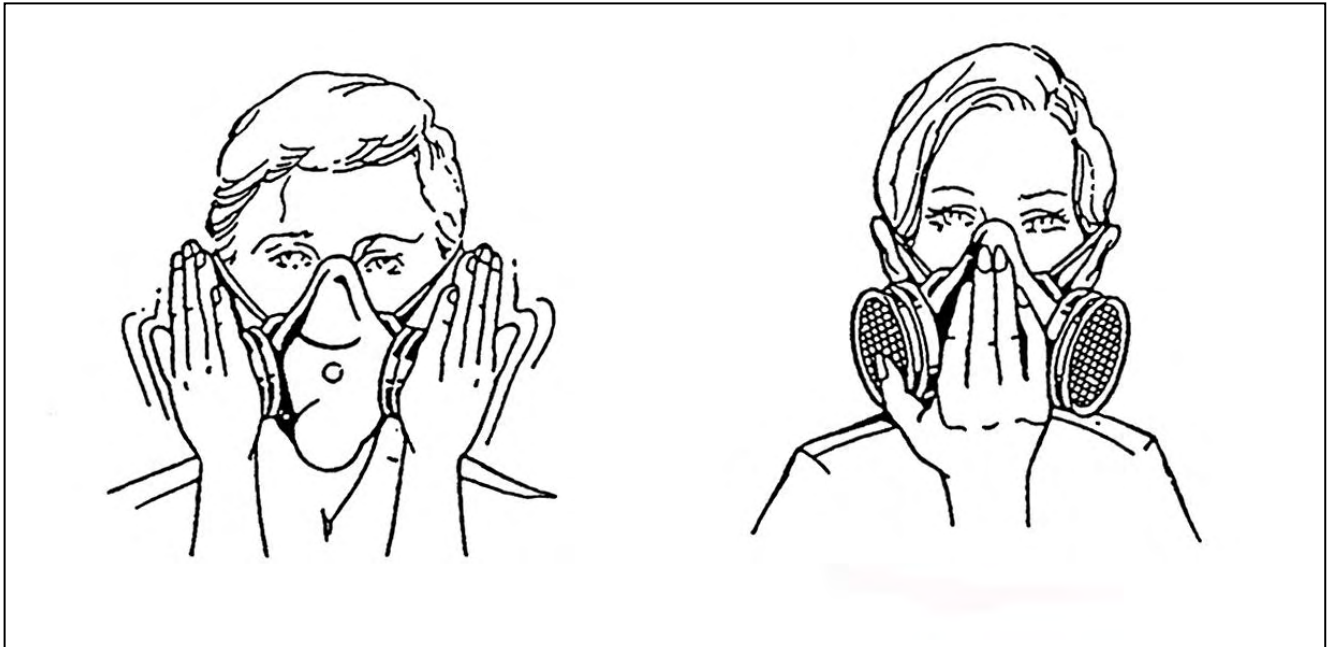

ISOAMYL ACETATE (Banana Oil) FIT TEST

For fit-testing the respirator must have an organic vapour cartridge in place. For filters, use irritant smoke.

After the user has completed step "A" above, saturate a cotton swab with banana oil or break a capsule or ampoule and pass it near the respirator along the face seal while the wearer:

- Performs side to side and nodding head movements.
- Breathes deeply as during heavy exertion.
- Speaks or reads loudly enough to be understood.

If the user reports smelling banana oil, the test must be repeated after adjusting the face-piece or selecting another respirator.

After obtaining a satisfactory fit, fill out the fit-test record.

Irritant Smoke Fit Test

Irritant smoke tests are done on respirators fitted with particle filter (dust, mist, fume or HEPA type). Irritant smoke is also used on full face respirators including air line respirators and Self-Contained Breathing Apparatus (SCBA).

NOTE: IT IS ACCEPTABLE TO USE BANANA OIL FOR FIT-TESTING IF THE PARTICLE FILTERS ARE REMOVED AND REPLACED WITH ORGANIC VAPOUR CARTRIDGES.

After the user has completed step "A" above, break the ends off the irritant smoke tube, attach the small bulb, and squeeze the smoke along the face seal while the user:

- Performs side to side and nodding head movements.
- Breathes deeply as during heavy exertion
- Speaks or reads loudly enough to be understood.

NOTE: THE USER MUST CLOSE HIS OR HER EYES DURING THIS TEST.

KEEP THE SMOKE TUBE ABOUT 15 CM (6") FROM THE FACE. SLOWLY WAVE THE TUBE TO DIRECT THE SMOKE TOWARDS THE RESPIRATOR. IF THE USER REPORTS SMELLING THE IRRITANT SMOKE, THE TEST MUST BE REPEATED AFTER ADJUSTING THE FACE-PIECE OR SELECTING ANOTHER RESPIRATOR.

After obtaining a satisfactory fit, fill out the fit-test record.

NOTE: THE SMOKE TUBE CONTAINS VERY IRRITATING CHEMICALS. SEE THE MATERIAL SAFETY DATA SHEET. NEVER PICK UP A BROKEN TUBE WITH BARE HANDS.

Respirator Fit Test Record

Name: _____ Initials: _____

Type of qualitative/quantitative fit test used: _____

Name of test operator: _____ Initials: _____

Date: _____

Respirator Mfr./Model/Approval no. **Size** **Pass/Fail or Fit Factor**
Note: "Fit factor" is numerical result of quantitative fit test from instrument reading

1. _____	S M L	P	F	_____
2. _____	S M L	P	F	_____
3. _____	S M L	P	F	_____
4. _____	S M L	P	F	_____

Clean Shaven? Yes___ No___ (Fit-test cannot be done unless clean-shaven)

Test Agent Used: **Irritant smoke:** **Banana oil:**

see "Respirator Fit-Test Instructions " for further detail

Medical Evaluation Completed? Yes___ No___

NOTES:

This record indicates that you have passed or failed a qualitative or quantitative fit test as shown above for the particular respirator(s) shown. Other types will not be used until fit tested.

Employee Respirator Training Record

Employee Name (printed)

I certify that I have been trained in the use of the following respirator(s):

This training included the inspection procedures, fitting, maintenance and limitations of the above respirator(s). I understand how the respirator operates and provides protection. I further certify that I have heard the explanation of the respirator(s) as described above and I understand the instructions relevant to use, cleaning, disinfecting and the limitations of the respirator(s).

Employee Signature

Instructor Signature

Date

Employer - Provided Information for Medical Evaluations

This form may be used by the employer to give to your medical provider, information on respirator use by your employees, but it is not a required form. You can also consult directly with your medical provider and discuss the information below. You must also give the medical provider a copy of your written respiratory program and copy of the Respirators Rules.

Specific Respirator Use Information

Employee Name: _____

Company/Employer: _____

Employee job title: _____

Company Address: _____

Company contact person and phone

Name: _____ #: _____

1. Will the employee be wearing protective clothing and/or equipment (other than the respirator) when using the respirator?

Yes/No _____ If "Yes," describe protective clothing and/or equipment:

2. Will employee be working under hot conditions (temperature exceeding 77°F)?

Yes/No _____ If "Yes", describe nature of work and duration:

3. Will employee be working under humid conditions? Yes / No _____

4. Describe any special or hazardous conditions the employee could encounter when using the respirator (for example, confined spaces, life-threatening gases).

Respiratory Protection Hazard Assessment and Selection Form

Agency/Institution: _____

Worksite: _____

General Description of Job Task: _____

Job Classification(s) _____

Level of physical exertion required to perform job: _____

Respiratory hazard(s) present: _____

PEL: _____ ACGIH TLV (if applicable): _____

Is monitoring data available? _____ Yes _____ No

If yes, attach to this form.

Contaminant concentrations present in the workplace:

Contaminant(s): _____ Concentration: _____

Contaminant(s): _____ Concentration: _____

Contaminant(s): _____ Concentration: _____

Does data indicate levels that exceed applicable limits? _____ Yes _____ No

Do data indicate IDLH concentrations? _____ Yes _____ No

Note: Wherever hazardous exposure(s) cannot be identified or reasonably quantified, the atmosphere must be considered IDLH.

Does data indicate oxygen deficiency (less than 19.5%)? _____ Yes _____ No

Is the respirator for routine use or emergency use? _____

Additional factors (i.e. temperature and humidity levels, etc.): _____

Communication requirements: _____

Are engineering/ administrative controls feasible? _____ Yes _____ No

If no, describe reasons: _____

Type of respirator selected: _____ air purifying _____ atmosphere supplying

Style of respirator selected: _____ tight-fitting _____ loose-fitting

Make: _____

Model# _____

Type of canister or cartridge to be used: _____

Cartridge/canister change schedule if applicable _____

Name of
Evaluator: _____ Date: _____

Title: _____

Work Phone: _____ Other: _____



Safe Work Practices / Procedures / Instruction

Occupational Silica Dust Exposure Control Plan

Sonic Drilling Ltd recognizes that exposure to silica dust can cause silicosis (a deadly lung disease) and may cause lung cancer. Sonic Drilling Ltd takes responsibility for protecting the safety and health of its employees.

The Occupational Silica Dust Control Program includes the following parts:

1. Hazard Identification
2. Worksite Air Monitoring
3. Employee Training
4. Housekeeping Procedures
5. Engineering Controls
6. Personal Hygiene
7. Personal Protective Equipment
8. Medical Examinations and Evaluation
9. Record Keeping
10. Emergency First Aid Procedures for Silica Dust
11. Spill and Disposal Procedures

Part 1. Hazard Identification

Sonic Drilling Ltd recognizes that the following job/task can produce silica dust at our workplace (Sandblasting, concrete cutting, determine hazards for each job site)

When any of these jobs/tasks are performed by a worker employed by Sonic Drilling Ltd they will be protected by the Occupational Silica Dust Exposure Control Program.

_____ is responsible for identifying silica dust exposure hazards.
(Supervisors Name)

Part 2. Worksite Monitoring

When a job/task is identified as a silica dust hazard the process and the worker's breathing zone will be monitored for silica dust concentrations. Employee exposure measurements must represent actual breathing zone exposure conditions for each employee.

Each job/task identified in part one will be monitored every four months and whenever a change is made to the process. Engineering controls will be monitored immediately after implementation and quarterly thereafter.

Employees will be able to view all air monitoring records; copies of the records can be found at

_____. _____ is responsible for the worksite monitoring program.
(Location) (Name)



Safe Work Practices / Procedures / Instruction

Part 3. Employee Training

All employees working in the job/tasks identified in part one are required to complete a training course prior to working in the exposure area. Workers will be trained when first assigned to the job/task and annually thereafter.

Training for the Occupational Silica Dust Exposure will include the following topics:

1. Health hazards of silica dust exposure (including signs and symptoms of silicosis).
2. Operations and materials that can produce silica dust exposure.
3. Engineering and work practice controls used to protect them from exposures.
4. The importance of proper equipment and control maintenance.
5. Housekeeping procedures.
6. Proper use of respirators and the respirator standard.
7. Personal Hygiene procedures to reduce exposures.
8. How smoking increases the risk of developing silicosis and other lung damage.
9. The details of the Occupational Silica Dust Exposure Control Program.

Training will be performed by _____. Records of attendance, dates of training, and training materials will be documented and located at _____. Additional training or reference material on silica dust exposure will be made available upon request to employees.

Part 4. Housekeeping Procedures

Dry sweeping and the use of compressed air are **prohibited** for removing dust in jobs/task identified in part one. Work areas and equipment covered by dust will be cleaned at the end of every shift by using a HEPA filter vacuum. Vacuums are stored at _____.

Wet clean up may also be used to remove dust.

Waste materials will be stored at _____ and will be removed at least weekly.

Supervisors are responsible for ensuring that work areas are free from dust at the end of each shift.

Part 5. Engineering Controls

Sonic Drilling Ltd will use engineering controls whenever possible to control silica dust exposures. Ventilation systems will be inspected and maintained by _____.

Ventilation systems will be checked at least weekly to determine if they are functioning properly. Sonic Drilling Ltd will not use abrasives that contain more than 1% crystalline silica during blasting options.

_____ is responsible for inspecting and maintaining engineering controls on all jobs.
(Name)



Safe Work Practices / Procedures / Instruction

Part 6. Personal Hygiene

Employees working at the job/tasks identified in part one will change out of contaminated clothing and work boots before leaving the jobsite. Contaminated clothing will be vacuumed with the HEPA filter vacuum to remove silica dust. Vacuums will be located at _____.

Lockers or container will be provided to store clean clothes at the jobsite. Employees are required to wash their hands and shower (when feasible) before leaving the worksite. Showers are located at _____; hand washing facilities are located at _____.

When worksites are located in the field away from normal operation, Sonic Drilling Ltd will provide portable containers to hand washing.

Employees will not eat, smoke, or use smokeless tobacco in the areas identified in part one.

Part 7. Personal Protective Equipment

When respirators are required to protect employees for silica dust exposure, Sonic Drilling Ltd Respirator Program will be strictly followed. Copies of the Respirator Program are located at _____.

Part 8. Medical Surveillance

All workers working in jobs/tasks identified in part one will be given medical examinations to prevent the development of silicosis. Medical examinations will be conducted once a year for employees working in jobs/tasks that expose them to silica dust.

Medical examinations must include (1) Chest X-rays, (2) Pulmonary function tests, and (3) tuberculosis evaluation.

Employees whose chest X-rays show changes consistent with the development of silicosis are customarily removed from job/tasks that expose them to silica dust. Input from the attending physician will be considered in making this decision.

Medical records will be made available at _____.

Part 9. Recordkeeping

Training, medical records, air monitoring, engineering control maintenance records, and injury records will be kept and located at _____.

_____ is responsible for the recordkeeping program.



Safe Work Practices / Procedures / Instruction

Part 10. Emergency First Aid Procedures for Silica Dust

1. Eye Exposure

If crystalline silica dust gets into the eyes, wash immediately with large amounts of water, lifting the lower and upper lids occasionally. If irritation is present after washing, get medical attention. Portable eyewashes will be kept at jobsites in the field away from the company locations.

2. Breathing

If a person breathes in large amounts of crystalline silica dust, move the exposed person to fresh air immediately. If breathing has stopped, perform artificial respiration. Keep the affected person warm and at rest. Get medical attention as soon as possible.

Part 11. Spill and Disposal Precautions

If crystalline silica is spilled or released in hazardous concentrations, the following steps must be taken:

1. Ventilate the area of the spill or release.
2. Persons doing the clean-up are required to wear appropriate respirators.
3. Collect spilled material in the most convenient and safe manner for reclamation or disposal in a secured sanitary landfill.

I have read and understand the requirements of this program and will participate in all training and safety precautions.

Employee Signature: _____ **Date:** _____.



Safe Work Practices / Procedures / Instruction

SITE SPECIFIC “SAFETY PROGRAM”

Safety Bulletin Board

Construction: (see diagram for approx. recommended dimensions)

Construction of the “Safety Bulletin Board” should be assessed and constructed with particular consideration for the protection of its contents due to weather. The protection portion of the board for weatherproofing can be addressed by utilizing a Plexiglass covering (preferred) or a thick Poly covering etc. The Map portion of the board shall be made utilizing a means that allows for easy modifications as required. Updates of the program must be done as job conditions warrant.

The safety board shall be mounted on or near the principal construction site shelter and/or as close to the main entrance of the site and made easily accessible for workers, visitors, and inspectors to review. A sign **must** also be posted at the front (main) entrance stating “**ALL Visitors Must Report To Site Office**” to ensure that everyone entering the site will be introduced to the safety information this provides, along with assuring that everyone is given a site orientation.

The contents of the board shall include (but not limited to) the following...

1. Prime Contractor, Site location Address and Contact Phone Numbers
2. Site Specific Map indicating layout of site (see “Site Safety Plan Map Contents” next page)
3. Emergency Response/Evacuation Plan, Emergency Contact Numbers (Fire, Police, Ambulance, Utilities, Poison Control Centre, Site Superintendent, CSO, First Aid Attendant) / Route to Hospital
4. Safety Meeting Minutes (**Once a month**) / Tool Box Talks (**Once a week**) POSTED
5. Safety Officer “Site Inspection Concerns” (shall be posted when/where required)
6. Certified Registered Professionals / Engineering / WCB / Contact Phone Numbers
7. Permits / Orders / Variances / Safety Bulletins etc. (City By-Law / WCB / Provincial regulation(s))
8. Ongoing details relating to site progress, site access, fire protection facilities, storage etc.

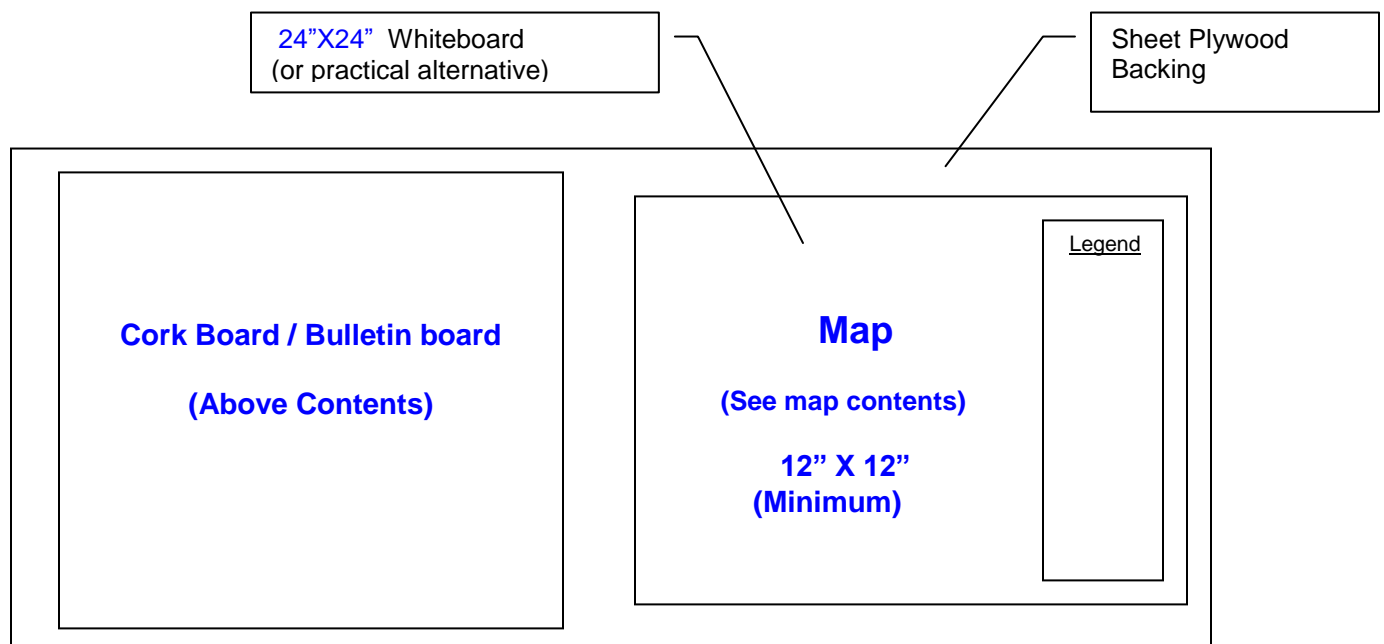

The above diagram is the preferred layout. Construct and adjust size according to requirements.



Safe Work Practices / Procedures / Instruction

[Site Safety Plan Map Contents](#) (Should include the following... or as site specifications require)

1. Prime contractor and site location
2. Location of all construction Fences / Hoarding around job site
3. Location of sidewalks / Covered walkways / walkways
4. Location of foot bridges and motor vehicle ramps / parking
5. Location of material and personnel hoist(s) and loading areas
6. Location of waste material chutes and containers
7. Location of construction material storage
8. Location of all cranes-derricks and hoists
9. Location of stand pipe system
10. Fire Extinguisher and Air Horn Sentries
11. Designated Smoking Area
12. Sidewalk(s), road and all traffic information
13. Entrance(s) and Exit(s) to site
14. First Aid Room and ETV location
15. Muster Station
16. Temporary power panel and main breaker (where/when necessary)
17. Combustible Storage Area Material Storage Area
18. Out of Bounds or Off Limit areas
19. Washroom facilities and Lunch room area
20. Location of Building Progression (Update progress when/where required)
21. Traffic Control Program showing transition and termination areas (when/where required)
22. Location of excavation area, when/where required
23. Buildings and Landmarks (as progress dictates)
24. A legend referencing map symbols meanings used to mark certain items

Please note this map should be placed on the "[Safety Bulletin Board](#)" as close as possible to the entrance for visitor information and reference. The map should be a **minimum** of 12" x 12" or as large as possible (depending on site layout) to accommodate necessary items and be easily readable.



Safe Work Practices / Procedures / Instruction

**SONIC DRILLING LTD
CONTACTS**

Site supervisor:	Phone:
Workplace Health & Safety Officer: Name	Phone:

WORK INJURY OR MEDICAL TREATMENT

Local medical centre – Address:	Phone:
Local hospital – Address: Address	Phone:

EMERGENCY SERVICES

Police, Fire, Ambulance	Phone: Phone:
-------------------------	------------------

Clearly state to the emergency service the following information:

- Your name and the company site name.
- The exact address of the site & the location of the injured person (if applicable).
- A brief description of the incident that occurred or relevant information.
- A brief description of the suspected injuries [if you know] and the number of injured persons.
- DO NOT HANG UP** until operator advises they have all necessary information.

After any emergency service is called, phone the site supervisor as soon as possible.

Other authorities need to be notified if there has been: (WorkSafeBC, Safety Authority)

- A death or serious injury on site causing the person to be hospitalized
- A fire, explosion or structural or other collapse, gas or other spill or leak or similar

<u>Health and Safety Coordinators</u>	<u>After hours – Office Hours</u>	<u>Name / Phone</u>
Name:	Company –	_____ / _____
<u>Phone</u>	Fax:	_____ / _____
	Project -	_____ / _____
Name:	Fax:	_____ / _____
<u>Phone</u>		_____ / _____



Safe Work Practices / Procedures / Instruction

EMERGENCY EVACUATION PROCEDURE

1. As soon as fire, or other threat is noticed, sound the horn/alarm and immediately evacuate area and notify others on site to do the same.
2. Do not attempt to fight fire unless properly trained and appropriate fire-extinguishing equipment available.
3. Notify Emergency Services **911**. Additional contact numbers on **Emergency Contacts List**
4. Encourage all persons on site to remain calm and orderly.
5. Shut down any and all equipment still operating.
6. Do not go back for tools, equipment or personal belongings. Do not attempt to move vehicles unless advised by emergency services.
7. If escaping through a smoke filled area, keep low to the floor [more oxygen] and move cautiously towards safe areas.
8. If trapped on a roof or higher level of the building, go to an outer window or space where a door can be shut and exit via scaffolding or attract attention from the window.
9. Once clear of the area and building – assemble at the muster station indicated on the site plan.

This SITE: Evacuation Plan

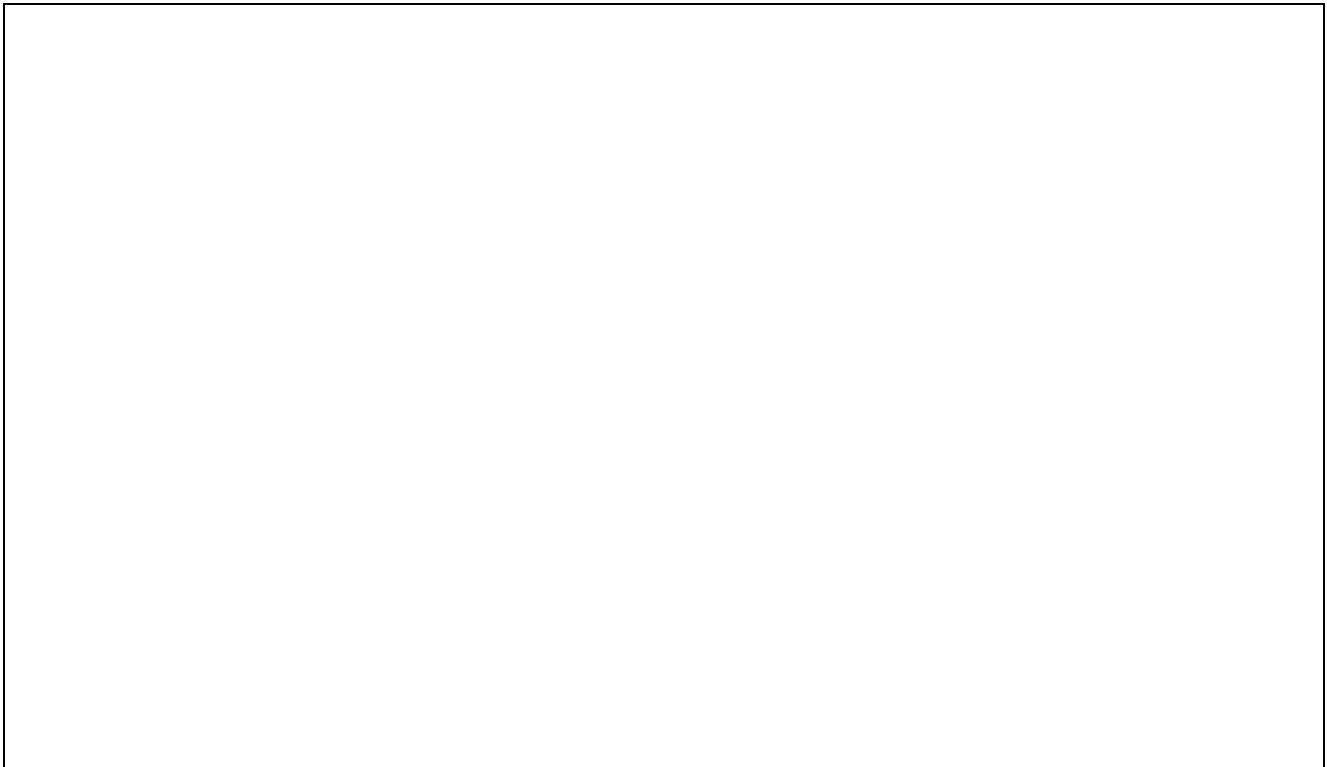



Program Review

17.0 PROGRAM REVIEW

Program review policy

Sonic Drilling Ltd management will monitor the company health and safety program(s) on an ongoing basis and will ensure an annual review is performed. Personnel involved in the program review will be qualified to do so. The review will examine all the elements of the program to ensure that the program continues to meet WorkSafeBC and company requirements. The improvements will be the result of input from the Management, the Safety Committee, the Employees, the Workers' Compensation Board, etc. Changes in work processes or the products used will be included in the program revision, if there is a change in the effect of the process or product on the health and safety of any employee.

Procedures

The introduction of a new work or a new product (with potential health and safety hazards) shall result in a review by the Management and the Safety Committee to ensure all health and safety safeguards are in place. Any significant change in the effects (or potential effects) on employees' health and safety, will be encompassed in the program to ensure that employees have access to that information.

Any major reduction of the effectiveness of the current Health and Safety Program will be immediately addressed by means of a full audit. The audit will identify the source of the problem(s) and will be modified to include corrective measures for the elimination of said problem(s).

Program Audit

The Health and Safety Program shall be audited and evaluated annually. The purpose of the audit is to ensure the program is being utilized and is effective and to investigate the safety activities and performance during the previous year within the context of the Program Manual. The audit will also be used to set measurable objectives and to outline specific safety activities, focal points, and revisions to procedures for the coming year.

The annual review will be based on an acceptable format to Certificate of Recognition requirements (COR) and WorkSafeBC standards. A written report, including unbiased evaluations, will be produced.

Upon completion of the written report Sonic Drilling Ltd will:

- Develop an action plan to implement practicable recommended revisions.
- Monitor the implementation of the action plan.